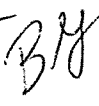

Agenda Item

DATE: December 13, 2017

TO: Dave Eggerton, General Manager 

FROM: Bob Godwin, P.E., Senior Civil Engineer 
Charles Palmer, District Engineer

SUBJECT: Presentation and Potential Adoption of the Final Draft of the La Contenta Wastewater Master Plan, CIP #15059L-130

RECOMMENDED ACTION:

Motion: _____ / _____ adopting Resolution No. 2017-___ approving the Final Draft of the La Contenta Wastewater Master Plan, CCWD CIP #15059L-130.

SUMMARY:

The process of updating the wastewater master plan for the community of La Contenta and adjoining service areas is complete with the submission of the attached Final Draft La Contenta Wastewater Master Plan dated December, 2017 for consideration and potential adoption by the Board.

The prior Master Plan for the La Contenta wastewater/sewer system was last adopted by the Board in 2005. The current Master Plan development/preparation began in the Fall of 2016, drafts were submitted for District review in February and July 2017, and one prior presentation occurred at the April 26, 2017 Board meeting. A final draft incorporating comments received at that presentation, and staff review comments from prior submittals were utilized in preparing the Final Draft Master Plan being presented today.

At this Board meeting, a presentation of the Final Draft Master Plan will be made by Mr. Kevin Kennedy, P.E. of Kennedy/Jenks Consultants. The presentation will summarize the contents of the Master Plan including review of planning criteria (service area, flowrates, peaking factors, storage and disposal requirements, etc.); consideration of the condition of existing wastewater facilities and recommendations for rehabilitation; and development of a capital improvement program addressing growth triggers and phasing for implementation, and budgetary estimates of the associated capital program costs.

FINANCIAL CONSIDERATIONS:

None at this time. Implementation of the Master Plan recommendations will lead into a separate financial analysis and evaluation of proposed capacity fees which will be presented to the Board for adoption at a future date.

*Attachments: Resolution No. 2017-___ Adopting the Final Draft of the La Contenta Wastewater Master Plan
Final Draft, December 2017 La Contenta Wastewater Master Plan*

RESOLUTION NO. 2017 –

A RESOLUTION OF THE BOARD OF DIRECTORS
OF THE CALAVERAS COUNTY WATER DISTRICT

ADOPTION OF THE FINAL DRAFT
OF THE LA CONTENTA WASTEWATER SYSTEM MASTER PLAN
CCWD CIP #15059L-130

WHEREAS, in order to better serve current and establish needs for future wastewater customers of the La Contenta wastewater service area, a wastewater facilities master plan has been updated for the community; and

WHEREAS, Kennedy/Jenks Consultants were retained by the District in 2016 to prepare the wastewater facilities master plan which is a replacement of the prior 2005 New Hogan / La Contenta Wastewater System Facilities Master Plan Update previously adopted by Resolution No. 2005-28; and

WHEREAS, the Board of Directors received the Draft La Contenta Wastewater System Master Plan at a public meeting on April 26, 2017 at which time a presentation was given for the purpose of receiving Board, staff, and public comment which have been incorporated into the Final Draft being submitted to the Board for consideration.

WHEREAS, the Board of Directors of Calaveras County Water District recognizes that funding of the costs of facilities recommendations within said plan update will be addressed by a financial analysis and evaluation of proposed capacity fees.

NOW, THEREFORE, BE IT FURTHER RESOLVED that the Board of Directors of the Calaveras County Water District hereby adopts the Final Draft of the La Contenta Wastewater System Master Plan, attached hereto and made a part hereof.

PASSED AND ADOPTED this 13th day of December, 2017, by the following vote:

AYES:

NOES:

ABSTAIN:

ABSENT:

CALAVERAS COUNTY WATER DISTRICT

President
Board of Directors

ATTEST:

Mona Walker, Clerk to the Board

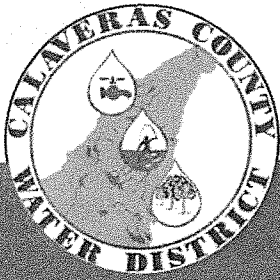

Calaveras County
Water District

FINAL DRAFT

La Contenta Wastewater System Master Plan

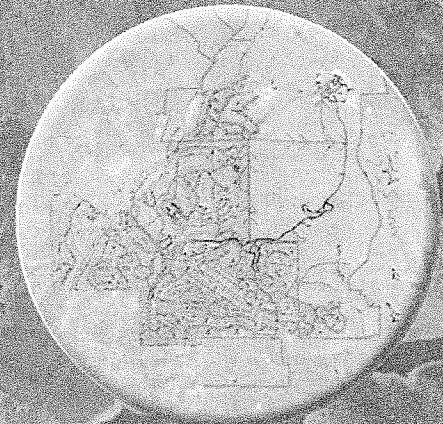

Kennedy/Jenks Consultants

December 2017

FINAL DRAFT

La Contenta
Wastewater System Master Plan

December 2017



Prepared under the responsible charge of

Kevin A. Kennedy, P.E.
Registration No. C61206

Kennedy/Jenks Consultants

10850 Gold Center Drive, Suite 350
Rancho Cordova, California 95670

Table of Contents

Executive Summary	ES-1
Section 1: Introduction.....	1
1.1: Background.....	1
1.2: Goals and Objectives	1
Section 2: Wastewater System Planning Criteria	3
2.1: Service Area.....	3
2.1.1: Existing Customers and Occupied Parcels	3
2.1.2: Future Developments	3
2.1.3: Infill	7
2.1.4: Summary of Existing and Future Service Area Connections	7
2.2: District Standards	9
2.2.1: Unit ADWF Factor.....	9
2.3: Wastewater Characteristics.....	10
2.3.1: Future Flow Projections	11
2.3.2: Historic and Future Pollutant Load Projections	12
2.3.3: Projected Flows and Loads.....	13
2.4: Regulatory Requirements.....	14
2.5: Phasing Requirements	14
2.6: Regional Geography	14
2.6.1: Topography.....	15
2.6.2: Hydrology	15
2.6.3: Ground and Surface Waters	15
Section 3: Evaluation of Existing Wastewater System	17
3.1: Collection and Conveyance	17
3.1.1: Sewer Collection System.....	17
3.1.2: Huckleberry Lift Station.....	19
3.2: Wastewater Treatment Facility.....	22
3.2.1: Influent Screening	22
3.2.2: Activated Sludge Process.....	27
3.2.3: Tertiary Filtration.....	28
3.2.4: Disinfection System	28
3.2.5: Chlorine Contact Basin (Currently Out of Service).....	28
3.3: Treated Effluent Storage and Beneficial Reuse/Disposal.....	28
3.3.1: Treated Effluent Storage Ponds	28
3.3.2: La Contenta Golf Course.....	28
3.4: Biosolids Storage and Disposal.....	29
3.4.1: WAS Storage Lagoon	29

3.4.2:	Solids Dewatering.....	29
Section 4:	Evaluation of Alternatives	31
4.1:	Collection and Conveyance Systems	31
4.1.1:	Recent Levels of Precipitation and Inflow/Infiltration Contributions.....	31
4.1.2:	Existing and Future Sewersheds.....	33
4.1.3:	I/I and Future Flow Projections.....	35
4.2:	Flow Pulsing Mitigation.....	35
4.3:	Wastewater Treatment Facility.....	35
4.3.1:	Influent Screening	35
4.3.2:	Activated Sludge Process.....	36
4.3.3:	Intermediate Clarifier	36
4.4:	Treated Effluent Storage and Disposal.....	37
4.4.1:	Seasonal Storage Implications	38
4.4.2:	Treated Effluent Disposal / Beneficial Reuse	38
4.5:	Biosolids.....	39
Section 5:	Recommended Improvements and Implementation Schedule	41
5.1:	Collection and Conveyance System.....	41
5.1.1:	Huckleberry Lift Station.....	41
5.1.1.1:	Phase 1 Improvements.....	41
5.1.1.2:	Buildout Improvements	41
5.2:	Wastewater Treatment Facility.....	41
5.3:	Seasonal Storage and Treated Effluent Disposal / Beneficial Reuse	43
5.4:	Summary of Improvements and Estimated Costs	43
5.5:	Implementation Schedule.....	44

List of Tables

Table ES1. Recommended Near-Term Phase 1 and Buildout Improvements and Estimated Costs.....ES-1

Table 1. Future Development Projections..... 7

Table 2. Service Area Projections (ESFUs)..... 7

Table 3. Historic Number of Connections and ADWFs 9

Table 4. Historic Influent Flows and Peaking Factors.....11

Table 5. Projected Phase 1 and Buildout Flows.....12

Table 6. Historic Raw Wastewater Pollutant Loadings and Peaking Factors.....12

Table 7. Existing TKN Loads13

Table 8. Projected Flows and Pollutant Loads13

Table 9. Summary of Existing Collection System17

Table 10. Unit Processes, Governing Criteria and Operating Conditions.....23

Table 11. 2016-2017 Wet Season Precipitation Measurements.....32

Table 12. Summary Water Balance Results – 100-year Level of Annual Precipitation.....38

Table 13. Estimated Phase 1 and Buildout Demands and Land Requirements.....39

Table 14. Recommended Near-Term and Phase 1 Improvements and Estimated Costs¹43

Table 15. Recommended Buildout Improvements and Estimated Costs¹44

List of Figures

Figure 1. La Contenta Wastewater System Service Area 4

Figure 2. Existing Customers and Occupied Parcels 5

Figure 3. Future Developments 6

Figure 4. Infill 8

Figure 5. Recommended and Historic Unit ADWF Factors10

Figure 6. Local and Regional Geography.....16

Figure 7. Existing La Contenta Wastewater System Collection System18

Figure 8. Huckleberry Lift Station System and Pump Curves20

Figure 9. Huckleberry Lift Station Flood Zones21

Figure 10. La Contenta Wastewater Treatment Plant Site Plan.....25

Figure 11. La Contenta Wastewater Treatment Plant Process Flow Schematic26

Figure 12. Instantaneous Flow Measurements (gpm) During Recent PWWF Event (January 10 and 11, 2017).....32

Figure 13. Recommended La Contenta Service Area Sewersheds34

Figure 14. Existing and Proposed Future Collection Systems, Sewersheds and Lift Stations42

References

Appendix

List of Abbreviations and Acronyms

AA	average annual
AAF	average annual flow
ac-ft	acre-foot, acre-feet
AD	Assessment District
ADWF	average dry weather flow
AFY	acre-feet per year
BFP	belt filter press
BOD ₅	Biochemical Oxygen Demand
CASGEM	California Statewide Groundwater Elevation Monitoring Program
CCR	California Code of Regulations
CCWD or District	Calaveras County Water District
CV-SALTS	Central Valley Salinity Alternatives for Long-Term Sustainability
District Standards	Calaveras County Water District Wastewater Design and Construction Standards
ENR	Engineering News Record
ESJS	Eastern San Joaquin Subbasin
ESFU	equivalent single family unit
FOG	fats, oils and grease
ft	feet
gpd	gallons per day
gpm	gallons per minute
HLS	Huckleberry Lift Station
HP	horsepower
I/I	infiltration and inflow
lb	pound
LCWWS	La Contenta Wastewater System
LCWWTF	La Contenta Wastewater Treatment Facility
LESP	Lower Effluent Storage Pond
Master Plan	La Contenta Wastewater System Master Plan
MD	maximum day
MDF	maximum day flow
MGD	million gallons per day
MM	maximum month
MMF	maximum month flow
MSW	municipal solids waste
PWWF	peak wet weather flow
RAS	return activated sludge
RWQCB	Regional Water Quality Control Board, Central Valley
SWRCB	State Water Resources Control Board
TKN	Total Kjeldahl Nitrogen
TSS	total suspended solids
UESP	Upper Emergency Storage Pond
UV	ultra-violet light
WAS	waste activated sludge

Executive Summary

The La Contenta Wastewater System (LCWWS) Master Plan (Master Plan) was developed to identify a series of cost-effective, phased improvements to meet planned growth, comply with current and future regulations and improve operations. Review of the LCWWS indicates that current wastewater flows and operating conditions require the treated effluent storage and disposal facilities to operate near their rated capacities. Service to infill and/or future developments may be limited unless capacity upgrades are implemented relatively soon.

Projected Phase 1 and Buildout average dry weather flows (ADWFs) are expected to increase from 0.14 million gallons per day (MGD) to about 0.26 and 0.45 MGD, respectively. This degree of growth represents an increase of 85 and 220 percent respectively. Table ES1 presents a summary of the improvements and estimated costs recommended to accommodate Phase 1 and Buildout conditions. In addition, it is recommended that CCWD develop a Repair and Replacement Program (R&R) for the LCWWS. At a minimum, assets with high consequence of failure should be assessed.

Table ES1. Recommended Near-Term, Phase 1 and Buildout Improvements and Estimated Costs¹

LCWWS Component	Estimated Total Costs	Expansion	Repair and Replacement
NEAR-TERM IMPROVEMENTS			
HLS Improvements	\$510,000	\$80,000	\$430,000
LCWWTF – Screen (Replacement in Kind)	\$300,000	\$20,000	\$280,000
Construction Subtotal	\$810,000	\$100,000	\$710,000
Design Engineering (10%)	\$81,000	\$10,000	\$70,000
Legal/Administration (5%)	\$40,000	\$15,000	\$40,000
Construction Management (10%)	\$81,000	\$10,000	\$70,000
Total	\$1,015,000	\$125,000	\$890,000
PHASE 1 IMPROVEMENTS (1420 ESFUs; ADWF 0.20 MGD)			
Collection and Conveyance System	Developer Provided		
LCWWTF – Activated Sludge Process	\$1,400,000	\$1,400,000	\$0
LCWWTF – Integral Clarifier	\$1,540,000	\$1,540,000	\$0
LCWWTF – UV Disinfection	\$110,000	\$110,000	\$0
Construction Subtotal	\$3,050,000	\$3,050,000	\$0
Design Engineering (10%)	\$305,000	\$305,000	\$0
Legal/Administration (5%)	\$155,000	\$155,000	\$0
Construction Management (10%)	\$305,000	\$305,000	\$0
Total	\$3,815,000	\$3,815,000	\$0
PHASE 1 IMPROVEMENTS (1570 ESFUs; ADWF 0.23 MGD)			
Seasonal Storage and Disposal	\$2,445,000	\$2,445,000	\$0
Construction Subtotal	\$2,445,000	\$2,445,000	\$0
Design Engineering (10%)	\$245,000	\$245,000	\$0
Legal/Administration (5%)	\$125,000	\$125,000	\$0
Construction Management (10%)	\$245,000	\$245,000	\$0
Total	\$3,060,000	\$3,060,000	\$0

LCWWS Component	Estimated Total Costs	Expansion	Repair and Replacement
BUILDOUT IMPROVEMENTS			
Collection and Conveyance	Developer Provided		
LCWWTF – Second Screen and Washer/ Compactor Additions	\$535,000	\$535,000	\$0
LCWWTF – Second Activated Sludge Process Train	\$1,175,000	\$1,175,000	\$0
LCWWTF – New Clarifier Addition	\$1,540,000	\$1,540,000	\$0
LCWWTF – Tertiary Filters (if required)	\$265,000	\$265,000	\$0
Seasonal Storage and Disposal	\$1,290,000	\$1,290,000	\$0
Construction Subtotal	\$4,805,000	\$4,805,000	\$0
Design Engineering (10%)	\$480,000	\$480,000	\$0
Legal/Administration (5%)	\$240,000	\$240,000	\$0
Construction Management (10%)	\$480,000	\$480,000	\$0
Total	\$6,010,000	\$6,010,000	\$0
Grand Total	13,900,000	\$13,010,000	\$890,000
Unit Cost	na	\$7,453/ESFU	na

¹ Costs developed June 2017 and reflect latest (April 2017) Engineering News Record (ENR) San Francisco CCI of 11696.

Section 1: Introduction

The La Contenta Wastewater System (LCWWS) Master Plan (Master Plan) was developed to identify a series of cost-effective, phased improvements to meet planned growth, comply with current and future regulations and improve operations. This section presents the background along with Master Plan goals and objectives.

1.1: Background

Calaveras County Water District (CCWD) was formed in 1946 to provide water and sewer service to the residents of Calaveras County. CCWD is a not-for-profit public agency, governed by a publicly elected five-member Board of Directors. CCWD owns and operates six major wastewater treatment plants and six small isolated wastewater systems. CCWD's second largest major wastewater treatment plant is the La Contenta Wastewater Treatment Facility (LCWWTF).

The LCWWTF treats the wastewater generated from CCWD's New Hogan / La Contenta service area. Prior to 1991, the LCWWTF was located on Huckleberry Lane and treated wastewater from the La Contenta Lakes Development and La Contenta Golf Club. In 1986, a land development project (Gold Creek Estates) was proposed within the New Hogan / La Contenta service area. It was at that time that CCWD entered into discussions to plan for and finance improvements to serve the proposed Gold Creek Estates and other planned developments. An assessment district (AD 604) was formed in 1991, and the LCWWTF was relocated to 1525 Campbell Court, Valley Springs, California. At that time, the property in which the LCWWTF was relocated to was believed to be large enough to accommodate buildout of the service area.

As of February 2017, existing customers (CCWD sewer connections) are 1,017 single family residential units, 1 multi-family residential unit and 54 commercial connections. Altogether current connections equate to a total of 1,111 equivalent single family units (ESFUs) as defined by CCWD's Wastewater Design and Construction Standards (District Standards) (CCWD, 2009). Current average dry weather flows (ADWFs) are between 0.13 and 0.16 million gallons per day (MGD) as described later. The LCWWTF currently has a rated ADWF permitted capacity of 0.2 MGD.¹

The LCWWS consists of the collection system, LCWWTF and treated effluent storage and disposal facilities. Treated effluent is stored in two reservoirs and beneficially disposed of seasonally via irrigation of the La Contenta Golf Course.

1.2: Goals and Objectives

The goals of this project are to develop a Master Plan that:

- Is tailored specifically for the District's LCWWS,
- Accommodates planned growth,
- Represents a series of phased and cost-effective improvements, and
- Is leveraged in the District's upcoming capital improvement and financial plans.

¹ As described in the Report of Waste Discharge (CCWD, 2013) and Waste Discharge Requirements (Regional Water Quality Control Board, Central Valley [RWQCB], 2013).

Review of the LCWWS indicates that that current wastewater flows and operating conditions require the treated effluent storage and disposal facilities to operate near their rated capacities. Master Plan objectives are to:

- Define existing and planned growth within the service area and project flows and pollutant loads,
- Compare approaches to increase capacity, comply with regulations and improve operations,
- Identify and describe triggers for recommended improvements,
- Recommend series of phased, cost-effective collection, treatment, storage and disposal facilities solutions that meet near-term (Phase 1) needs, and
- Determine and describe improvements recommended for Buildout.

Section 2: Wastewater System Planning Criteria

This section describes LCWWS planning criteria, including the service area, wastewater characteristics, phasing requirements and relevant hydrologic, geologic and topographic features. This information will be drawn from and will serve as the basis for subsequent evaluations, comparisons and recommendations.

2.1: Service Area

Figure 1 is a map showing the service area boundary and the locations of the La Contenta Wastewater Treatment Facility (LCWWTP) and Upper and Lower Effluent Storage Ponds (UESP, LESP, respectively). As shown, the LCWWS service area is bordered by Rancho Calaveras subdivision in the south, State Highway 26 to the west and Hogan Dam Road to the east and north. The service area includes La Contenta Lakes Development and the La Contenta Golf Club, AD 604, and adjacent residential and commercial developments which were annexed into the service area in the early 1990's.

2.1.1: Existing Customers and Occupied Parcels

As previously described, the LCWWS is comprised of wastewater collection, treatment, storage and disposal facilities currently serving 1,111 ESFUs. Existing customers and occupied parcels within the LCWWS are shown in Figure 2. A current list of existing customers and occupied parcels was provided by CCWD and is attached to the appendix for reference.

2.1.2: Future Developments

For the purposes of the Master Plan, future development is defined as large vacant parcels that would require extension of the existing LCWWS collection system to provide wastewater service. Figure 3 shows future developments and categorizes these future developments into Phase 1 and Buildout based on input received from the Calaveras County Planning Department.

Table 1 presents a summary of Phase 1 and Buildout development projections. For the purposes of the Master Plan, Phase 1 developments are defined as those that have been discussed with the Calaveras County Planning Department, are considered pending and/or approved and represent near-term development. By default, Buildout developments are then defined as being the remaining non-Phase 1 large vacant parcels.

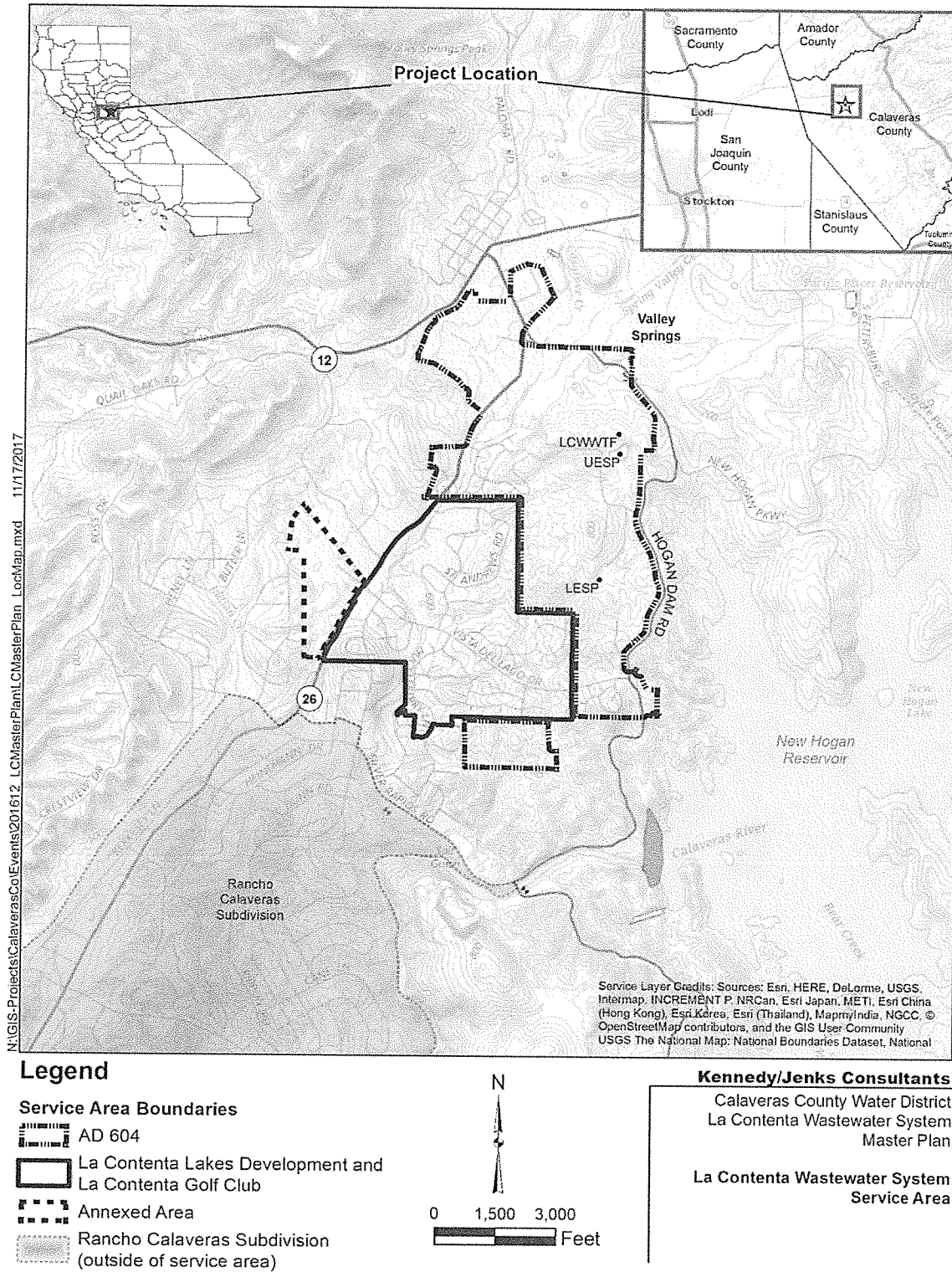

Figure 1. La Contenta Wastewater System Service Area

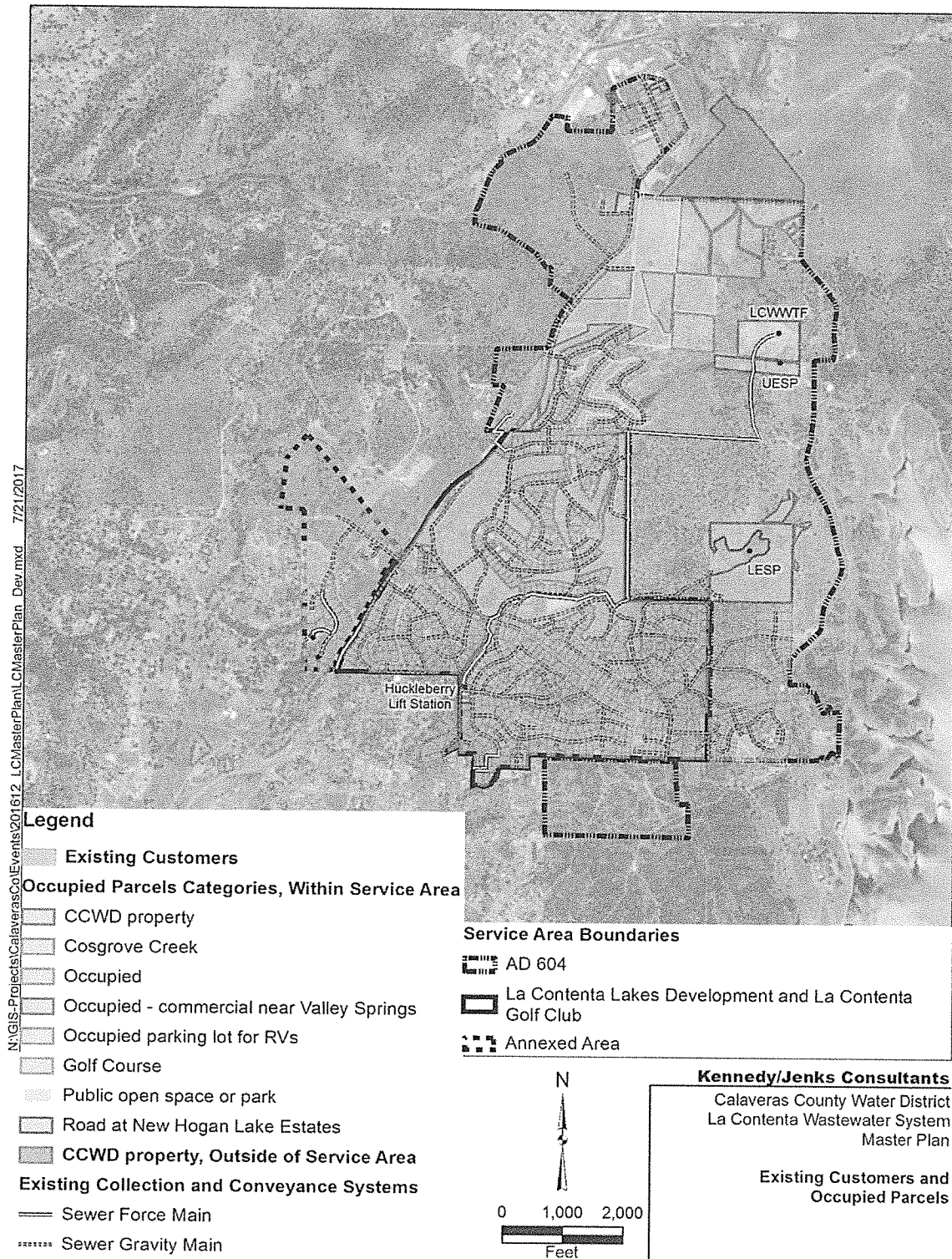
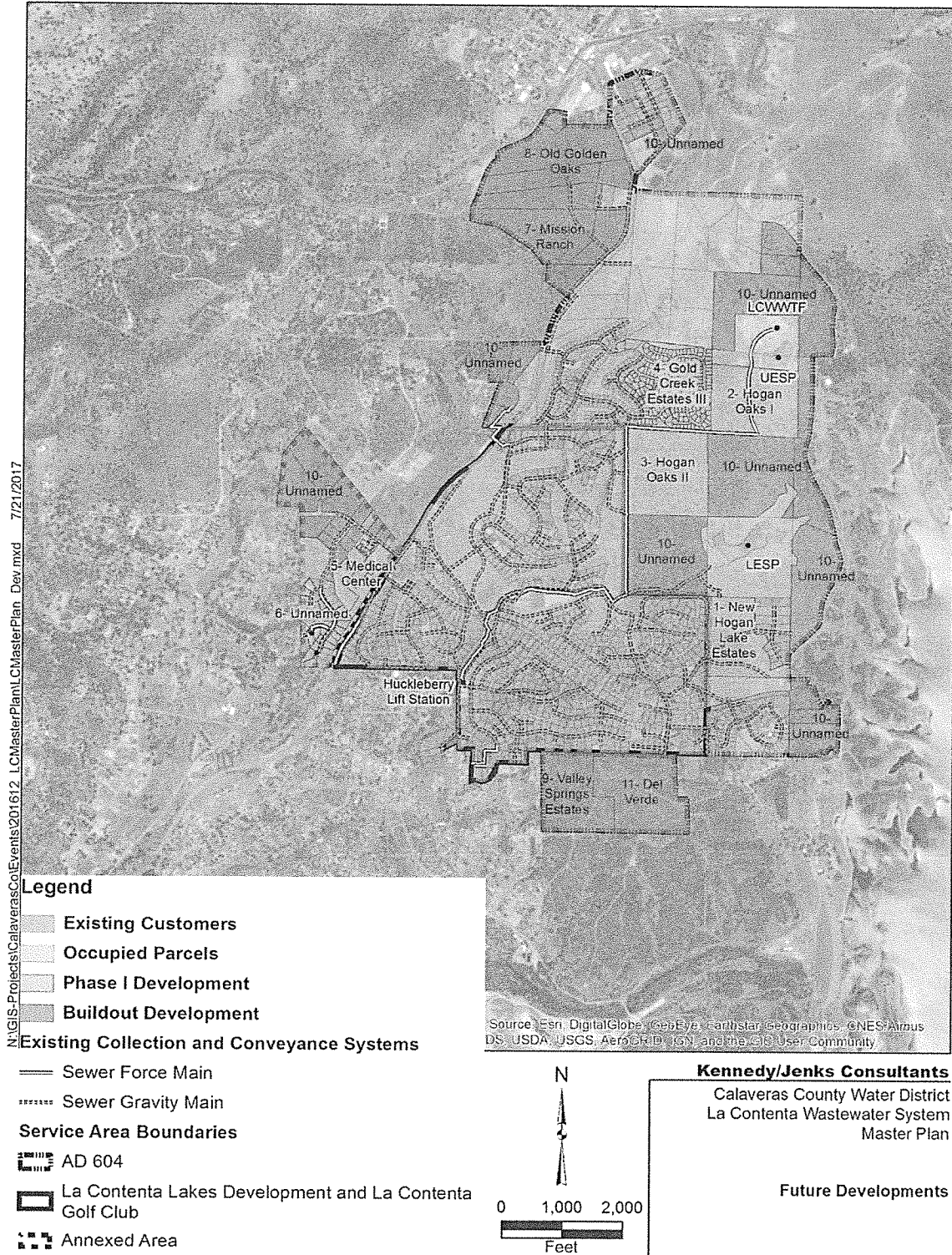

Figure 2. Existing Customers and Occupied Parcels



N:\GIS-Projects\Calaveras\CalEvents\2016\12_LCMasterPlan\LCMasterPlan_Dev.mxd 7/21/2017

Figure 3. Future Developments

Table 1. Future Development Projections

Reference No.	Future Developments	Description and Status	ESFUs
Phase 1			
1	New Hogan Lake Estates	83 units; 4 built	87
2	Hogan Oaks I	51 residential homes	51
3	Hogan Oaks II	143 residential plus multi-dwelling units	143
4	Gold Creek Estates III	75 residential units; approved	75
5	Medical Center	Buildout 100,000 sq. ft., 1 ESFU/2,000 sq. ft.	50
6	Unnamed		17
Phase 1 Subtotal			423
Buildout			
7	Mission Ranch	Pending	146
8	Old Golden Oaks	Pending	96
9	Valley Springs Estates	Not Currently in Planning	71
10	Unnamed	Not Currently in Planning	541
11	Del Verde	Foreclosed	91
Buildout Subtotal			945
Total			1,368

The number of connections and ESFUs associated with Phase 1 developments were based on information obtained from the CCWD and Calaveras County Planning Department. These data were used to translate number and type of connections to ESFUs. Buildout developments were estimated using Calaveras County Planning Department land-use designations in conjunction with land-use definitions obtained from the updated General Plan (Calaveras County, 2016). As shown in Table 1, the estimated number of future new ESFUs for Phase 1 and Buildout are projected to be 423 and 945, respectively.

2.1.3: Infill

For the purposes of the Master Plan, infill is defined as empty parcels within the LCWWS service area that are neither occupied, categorized as future developments, nor require extension of the existing LCWWS collection system for service. Infill parcels are shown in Figure 4. The estimated number of infill connections in terms of ESFUs is 216.

2.1.4: Summary of Existing and Future Service Area Connections

Table 2 presents a summary of existing and future service area projections. These projections, in combination with unit flow factors will serve as the basis for projecting raw wastewater influent flows. Buildout projections indicate that the number of connections within the service area is anticipated to increase by about 140 percent.

Table 2. Service Area Projections (ESFUs)

Service Area Component	Existing	Phase 1	Buildout
Existing and Occupied Parcels	1,111	1,111	1,111
Infill	0	216	216
Future Development	0	423	1,368
Total	1,111	1,750	2,695

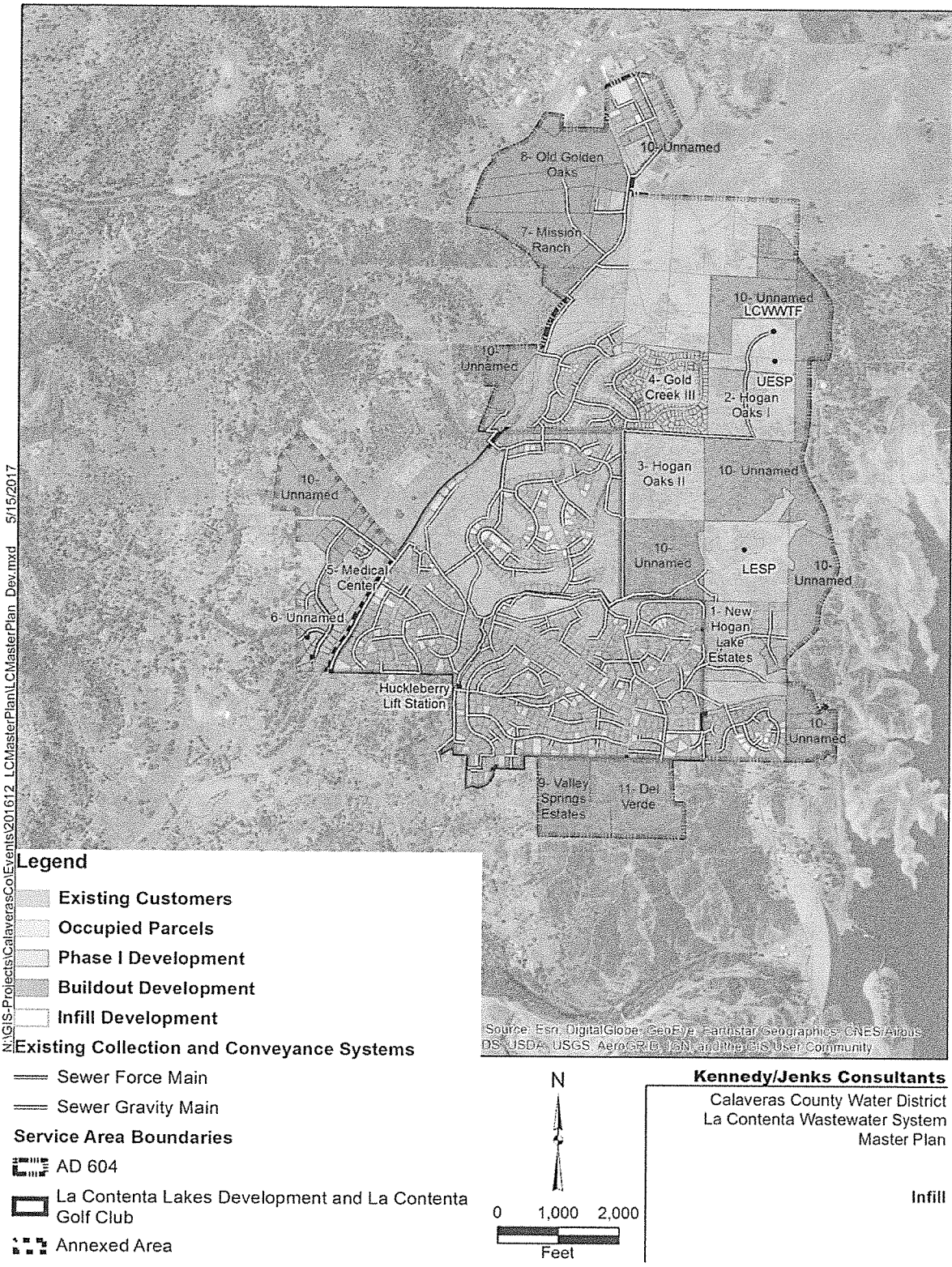

Figure 4. Infill

2.2: District Standards

The District Standards were adopted by the Board of Directors in 2009 (CCWD, 2009) and provide procedures and minimum guidelines for the planning, design, and construction of CCWD wastewater systems and facilities. District Standards apply to existing wastewater systems being expanded, modified, upgraded and rehabilitated as well as to the construction of new facilities.

2.2.1: Unit ADWF Factor

The District Standards identify equivalent single family dwelling units, ESFUs, to standardize flows for different types of service connections based on typical demand. ESFUs are used to project future wastewater ADWFs and PWWFs. The District Standards describe that a unit ADWF factor of 195 gallons per day (gpd) per ESFU (gpd/ESFU) shall be used for projecting future development wastewater contributions.

Table 3 presents a summary of the historic number of connections in terms of ESFUs and ADWFs. As indicated in Table 3 and illustrated in Figure 5, the highest historic value of 150 gpd/ESFU occurred in 2009, and the next highest value of 145 gpd/ESFU occurred the year before in 2008. As anticipated, averages for the last three to five years are lower, due to drought and mandatory water conservation cutbacks, and are between 115 and 120 gpd/ESFU².

Table 3. Historic Number of Connections and ADWFs

Year	No. of Connections ¹	Growth Rate (%) ²	ESFUs ³	ADWF ⁴ (MGD)	Unit ADWF Factor ⁵ (gpd/ESFU)
2008	990	na	1,024	0.15	145
2009	996	0.61	1,031	0.15	150
2010	996	0.00	1,031	0.14	132
2011	997	0.10	1,032	0.14	133
2012	999	0.20	1,034	0.13	125
2013	1,000	0.10	1,035	0.13	127
2014	1,000	0.02	1,035	0.12	117
2015	1,012	1.22	1,048	0.11	110
2016	1,070	5.69	1,111	0.13	115
				Average	128

¹ Number of connections provided by CCWD and reflects historic 2008-2016 data.

² Growth rate calculated based on number of connections.

³ 2008 through 2015 ESFUs estimated based on the current number of ESFUs (1,111 for 2016 provided by CCWD) and calculated growth rates.

⁴ ADWFs were CCWD provided, reflect historic data and are based on the permit ADWF definition (average daily flow from the months of July through September).

⁵ ADWF/ESFU calculated by dividing ADWF by the number of ESFUs.

na = not available.

² More recent averages represent 19 to 22 % reduction when compared to historic 2008 and 2009 values.

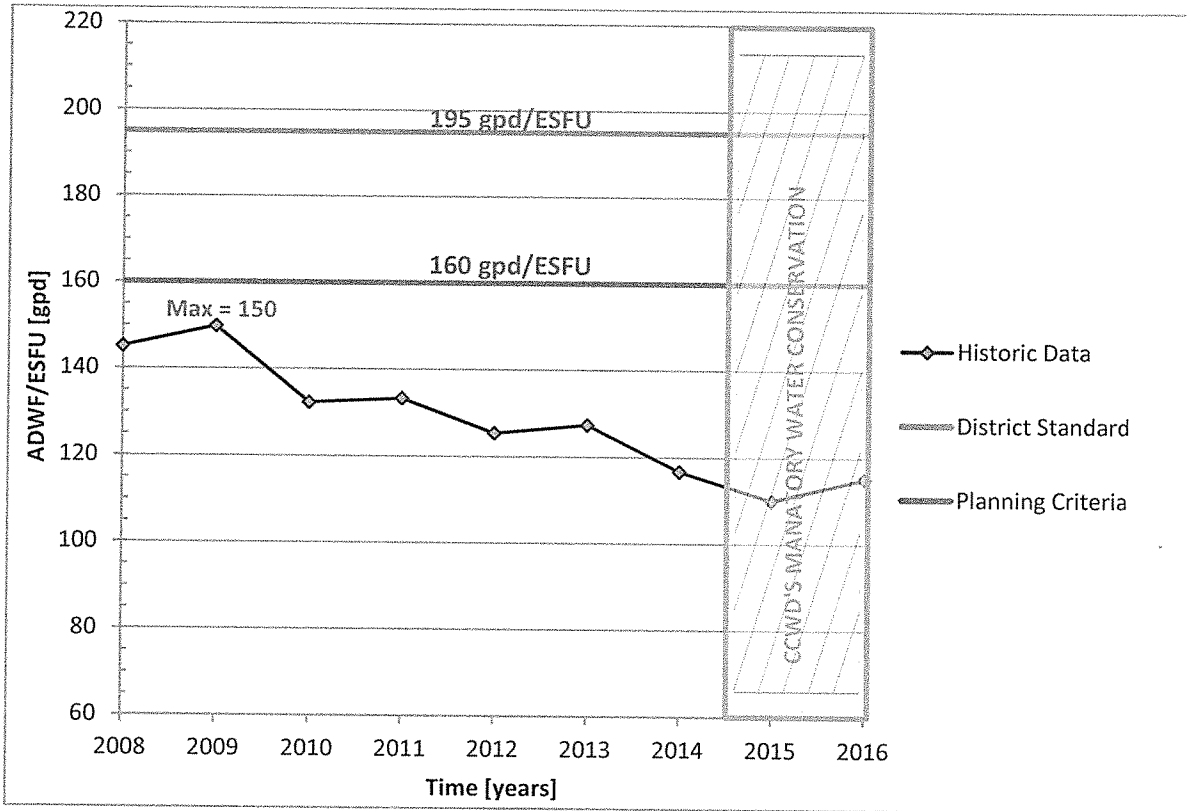

Figure 5. Recommended and Historic Unit ADWF Factors

Historic unit ADWF factors and the District standard of 195 gpd/ESFU were discussed with CCWD staff during the kickoff meeting on September 9, 2016 (CCWD, 2016a). During these discussions, it was decided that for the purposes of the Master Plan, unit ADWF factors of 160 and 195 gpd/ESFU would be used to establish a range of projected future connections and influent flows. The 160 gpd/ESFU value was selected because (1) it is greater than all historic unit flow factors between 2008 and 2016, which is a desirable outcome and (2) provides a relatively small cushion (i.e., 6.7%) above the highest historic flow factor of 150 gpd/ESFU when compared to the District Standard of 195 gpd/ESFU (i.e., 30% cushion as compared to the historic 2009 value).

2.3: Wastewater Characteristics

Existing wastewater characteristics representing current flows and pollutant loadings were developed. Characteristics are compared to current LCWWTF operation conditions later (i.e., Table 10) to (1) determine the relative degree of loading as compared to established governing design/operating criteria for each facility and major individual unit process within each facility and to (2) identify future improvements needed to accommodate Phase 1 and Buildout projections.

Table 4 is a summary of historic ADWFs, average annual flows (AAFs), maximum month flows (MMFs) and maximum day flows (MDFs) developed from data obtained from CCWD. Characteristics for these specific conditions (e.g., average annual, maximum month, maximum day) were developed because these conditions correspond to specific regulatory permit requirements. The methodology described in Table 4 and the District Standards were used to project peak wet weather flows (PWWFs). District Standard 1.2.1 defines PWWF as the number of ESFUs multiplied 195 gpd/ESFU and a peaking factor of 3.

Table 4. Historic Influent Flows and Peaking Factors

Year	ADWF	AAF	MMF	MDF	PWWF ¹
Historic Influent Flows (MGD)					
2008	0.15	0.17	0.27	0.42	0.60
2009	0.15	0.18	0.27	0.39	0.60
2010	0.14	0.14	0.26	0.48	0.60
2011	0.14	0.17	0.21	0.49	0.60
2012	0.13	0.15	0.20	0.43	0.60
2013	0.13	0.14	0.17	0.23	0.61
2014	0.12	0.14	0.20	0.57	0.61
2015	0.12	0.13	0.22	0.47	0.61
Average	0.14	0.15	0.23	0.44	0.60
Peaking Factors (ratio to ADWF; unitless)					
2008	1.00	1.14	1.81	2.84	na
2009	1.00	1.18	1.72	2.55	na
2010	1.00	1.01	1.88	3.49	na
2011	1.00	1.21	1.55	3.59	na
2012	1.00	1.16	1.54	3.29	na
2013	1.00	1.09	1.29	1.71	na
2014	1.00	1.15	1.63	4.73	na
2015	1.00	1.14	1.91	4.05	na
Average	1.0	1.1	1.7	3.3	na

¹ PWWF calculated from CCWD Standard 1.2.1: PWWF = 195 gpd/ESFU, multiplied by the number of ESFUs, multiplied by a peaking factor of 3.

na = not applicable.

Although the number of connections increased between 2008 and 2015, the historic ADWFs decreased, likely due to mandatory CCWD water conservation measures taken during the drought. As described in Table 4, the current ADWF is estimated to be 0.14 MGD. ADWFs shown in Table 4 are the arithmetic average of daily influent flows for July through September, as described in the Report of Waste Discharge. This methodology is anticipated to provide an approximation of the LCWWS service area base wastewater flows with no or limited direct rainfall contribution, infiltration or inflow and will be used to project future AAFs, MMFs, MDFs.

2.3.1: Future Flow Projections

Historic 2008 through 2015 flows and peaking factors were averaged to estimate current conditions and represent the current ADWF, AAF, MMF and MDF. Current PWWF was estimated using both the District Standard 1.2.1, and historic data obtained from CCWD. Historic data indicates a PWWF of 0.94 MGD, which corresponds to a peaking factor of 6.7; which is considerably higher than the 3 peaking factor described in Table 4 and the District Standards.

ADWF was estimated for Phase 1 and Buildout conditions using unit flow factors of 160 and 195 for new connections and adding the projected additional flow to the existing flow of 0.14 MGD. AAF, MMF, MDF and PWWF were estimated for Phase 1 and Buildout conditions using peaking factors shown in Table 5. As shown in Table 5, Phase 1 and Buildout projections are estimated using both the District Standard of 195 gpd/ESFU and 160 gpd/ESFU.

Table 5. Projected Phase 1 and Buildout Flows

Condition	Current	Phase 1 (MGD)		Buildout (MGD)	
		160 gpd/ESFU	195 gpd/ESFU	160 gpd/ESFU	195 gpd/ESFU
ADWF	0.14	0.24	0.26	0.39	0.45
AAF	0.15	0.26	0.29	0.43	0.50
MMF	0.23	0.41	0.44	0.66	0.77
MDF	0.44	0.79	0.86	1.29	1.49
PWWF ¹	0.65	0.93	1.01	1.29	1.57
PWWF	0.94 ²	1.61	1.74	2.61	3.02

¹ PWWF calculated from CCWD Standard 1.2.1: PWWF = 195 gpd/ESFU, multiplied by number of ESFUs, multiplied by a peaking factor of 3.

² Huckleberry Lift Station flow record from roughly 10 pm, January 10, 2017 through 20 minutes past midnight on January 11, 2017 indicate a PWWF of 655 gallons per minute (gpm) which is equivalent to 0.94 MGD.

2.3.2: Historic and Future Pollutant Load Projections

Table 6 is a summary of historic pollutant loading conditions, including average annual (AA), maximum month (MM) and maximum day (MD) conditions for five-day Biochemical Oxygen Demand (BOD₅) and total suspended solids (TSS). Historic data were plotted using a lognormal cumulative probability density function to determine the 50-, 91.7- and 99.7-percentile probabilities correlating to the AA, MM and MD conditions. AA represents the 50 percentile value; MM reflects 11 out of 12 months or the 91.7-percentile value and MD reflects 364 out of 365 days or the 99.7 percentile value. Pollutant load peaking factors are also presented in Table 6 which reflects the ratio to the AA pollutant loads. Log-normal plots are provided in the appendix for reference.

Table 6. Historic Raw Wastewater Pollutant Loadings and Peaking Factors

Year	AA	MM	MD	AA	MM	MD
Historic BOD₅ Loadings (lbs/day)			BOD₅ Loading Peaking Factors			
2008	293	554	690	1.00	1.89	2.35
2009	252	460	633	1.00	1.83	2.51
2010	168	350	503	1.00	2.08	2.99
2011	69	297	459	1.00	4.30	6.65
2012	130	370	515	1.00	2.85	3.96
2013	217	290	350	1.00	1.34	1.61
2014	238	392	480	1.00	1.65	2.02
2015	101	360	530	1.00	3.56	5.25
Average	184	384	520	1.0	2.4	3.4
Historic TSS Loadings (lbs/day)			TSS Loading Peaking Factors			
2008	160	270	413	1.00	1.68	2.58
2009	196	362	468	1.00	1.85	2.39
2010	130	268	397	1.00	2.06	3.05
2011	68	151	180	1.00	2.22	2.65
2012	100	260	361	1.00	2.60	3.61
2013	248	434	488	1.00	1.75	1.97
2014	na	na	na	1.00	na	na
2015	na	na	na	1.00	na	na
Average	150	290	385	1.0	2.0	2.7

na = not available.

The AA, MM, and MD BOD₅ and TSS pollutant loadings and peaking factors between 2008 and 2015 were averaged used to reflect current loading conditions.

Current BOD₅ and TSS loads of 184 and 150 lbs/day, were divided by the current number of ESFUs (1,111) to determine unit pollutant loading factors of 0.17 lb BOD₅/ESFU day and 0.14 lb TSS/ESFU day, respectively. These values will serve as the basis for projecting future pollutant loading conditions.

Raw wastewater influent samples were collected on November 28, 29 and 30, 2016 and analyzed for Total Kjeldahl Nitrogen (TKN) by an outside and certified laboratory. Analyses results indicated that TKN concentrations were 50, 52 and 47 mg-N/L and estimated TKN loads were 87, 77 and 67 lb-N/d, respectively.

2.3.3: Projected Flows and Loads

Table 8 is a summary of projected raw wastewater flows and pollutant loadings to the LCWWTF for Phase 1 and Buildout. Projected flows for Phase 1 and Buildout were estimated and added to existing conditions using both 160 and 195 gpd/ESFU. Projected Total Kjeldahl Nitrogen (TKN) loads represent an average of data collected in 2016, found in Table 7, and BOD₅ peaking factors found in Table 6. Detailed calculations are included in the appendix.

Table 7. Existing TKN Loads

TKN [mg-N/L]	Date	Flow	TKN [lbs - N/day]
50	11/28/2016	.209	87
52	11/29/2016	.177	77
47	11/30/2016	.170	67

Table 8. Projected Flows and Pollutant Loads

Parameter	Average Dry Weather	Average Annual	Maximum Month	Maximum Day	Peak Wet Weather
Current					
Flow (MGD)	0.14	0.15	0.24	0.44	0.94
BOD ₅ (lbs/day)	na	184	384	520	na
TSS (lbs/day)	na	150	290	385	na
TKN (lb-N/day)	na	77	185	262	na
Phase 1					
Flow (MGD) (160 gpd/ESFU)	0.24	0.26	0.41	0.79	1.23
Flow (MGD) (195 gpd/ESFU)	0.26	0.29	0.44	0.86	1.24
BOD ₅ (lbs/day)	na	286	686	972	na
TSS (lbs/day)	na	233	466	629	na
TKN (lb-N/d)	na	121	290	411	na
Buildout					
Flow (MGD) (160 gpd/ESFU)	0.39	0.43	0.67	1.29	1.90
Flow (MGD) (195 gpd/ESFU)	0.45	0.50	0.77	1.49	1.96
BOD ₅ (lbs/day)	na	445	1,068	1,513	na
TSS (lbs/day)	na	363	726	980	na
TKN (lb-N/d)	na	187	446	632	na

2.4: Regulatory Requirements

CCWD received a Notice of Applicability on December 13, 2012 for the LCWWTF to discharge under the State Water Resources Control Board (SWRCB) Water Quality Order No. 2009-0006-DWQ. Currently irrigation at the La Contenta Golf Course is the only means of treated effluent disposal. Specific treatment and use standards are as follows:

1. Producer (CCWD) shall produce disinfected tertiary recycled water, as defined in California Code of Regulations (CCR) Title 22, sections 60301.230 and 60301.320,
2. Distributor (CCWD) shall comply with the applicable uniform statewide reclamation criteria established pursuant to California Water Code (CWC) section 13521 (i.e., CCR Title 22 section 60301 et. seq., hereafter "Title 22 Requirements"), and
3. Producer and Distributor shall ensure that Users comply with the applicable uniform statewide reclamation criteria established pursuant to Title 22 Requirements.

Producer and Distributor shall satisfy all applicable requirements of the Recycled Water Policy (included to the appendix along with Water Quality Order [WQO] No. 2009-0006-DWQ for reference).

2.5: Phasing Requirements

The following will serve as guidelines for the phasing of recommended improvements:

- Phase 1 and Buildout development to be based on projections of 1,750 and 2,695 ESFUs.
- ADWFs to be based on unit flow factors of 160 and 195 gpd/ESFU.
- Rated ADWF capacities to reflect existing rated capacity of 0.2 MGD and as discussed with Parkson, an increased ADWF of 0.26 MGD to match Phase 1 ADWF projections.
- Incremental treated effluent storage and disposal capacity increases to be defined by CCWD. Most likely increases are to reflect properties currently owned or being considered for ownership by CCWD and forecasted CCWD budgets for incremental storage and treated effluent disposal improvements.
- The scope of this Master Plan is limited to identifying LCWWS improvements required to serve planned growth. Other requirements (e.g., environmental, traffic, etc.) may have an impact on development timing but are NOT considered in this report.

2.6: Regional Geography

Relevant geographical planning criteria (i.e., elevation, temperatures, soil composition and surface and groundwater conditions) that may have impacts on long-term treated effluent storage and/or disposal alternatives are described below.

2.6.1: Topography

As indicated in Figure 6, land surrounding the LCWWTF and service area is characterized by a variety of topographical features, including valleys, rolling foothills, creeks, rivers, wetlands, and reservoirs. The topography is of particular concern when considering facility alternatives. Depending on the specific LCWWS component, elevation changes, steep terrain, wetlands and rivers likely have an adverse effect on future treated effluent storage and disposal site viability and costs. Topography may require the installation of lift stations, dictate current, and may restrict future, flow paths to and within the LCWWTF, limit land available for storage ponds and may restrict the application of sprayfields for treated effluent disposal.

2.6.2: Hydrology

The service area is located within the Lower Calaveras River Watershed. Cosgrove Creek flows north to south through the La Contenta Lakes Development and converges with the Calaveras River just west of New Hogan Dam.

The extensive network of rivers, creeks, wetlands and the surrounding watershed affects the availability of land that can be used for treated effluent disposal/recycled water distribution. The cost of land and its suitability for treated effluent disposal/beneficial reuse will be considered in the alternatives analysis.

2.6.3: Ground and Surface Waters

Immediately east of the LCWWTF, flows from the New Hogan Reservoir are released into Calaveras River, which ultimately discharges into the San Joaquin River and on to the Sacramento Delta. The San Joaquin River supplies many farmers located within the San Joaquin Valley, as well as industrial and domestic users located along the eastern shore of the San Francisco Bay (Limbaugh, 2016).

The LCWWS is located along the border of the Eastern San Joaquin Subbasin (ESJS), a subbasin of the San Joaquin Valley groundwater basin and the Yosemite Valley groundwater basin. This region is heavily groundwater reliant and the ESJS was identified by the Department of Water Resources as critically overdrafted in 1980. The list was updated in 2003, 2015 and 2017, and the ESJS has remained critically overdrafted (California Department of Water Resources [DWR], 2015). Overdrafting can result in lowering groundwater levels, a reduction in groundwater storage, water quality degradation, land subsidence and depletion of surface water.

California Statewide Groundwater Elevation Monitoring Program (CASGEM), a program created in response to Senate Bill SBX7 6, is a statewide groundwater level monitoring program established to monitor long-term groundwater trends. CCWD has been designated as the monitoring entity for the specific areas in Calaveras County that lie within the ESJS (CCWD, 2012 b). CCWD's network of 11 monitoring and observation wells are used to collect semi-annual groundwater levels which are uploaded to the CASGEM website.

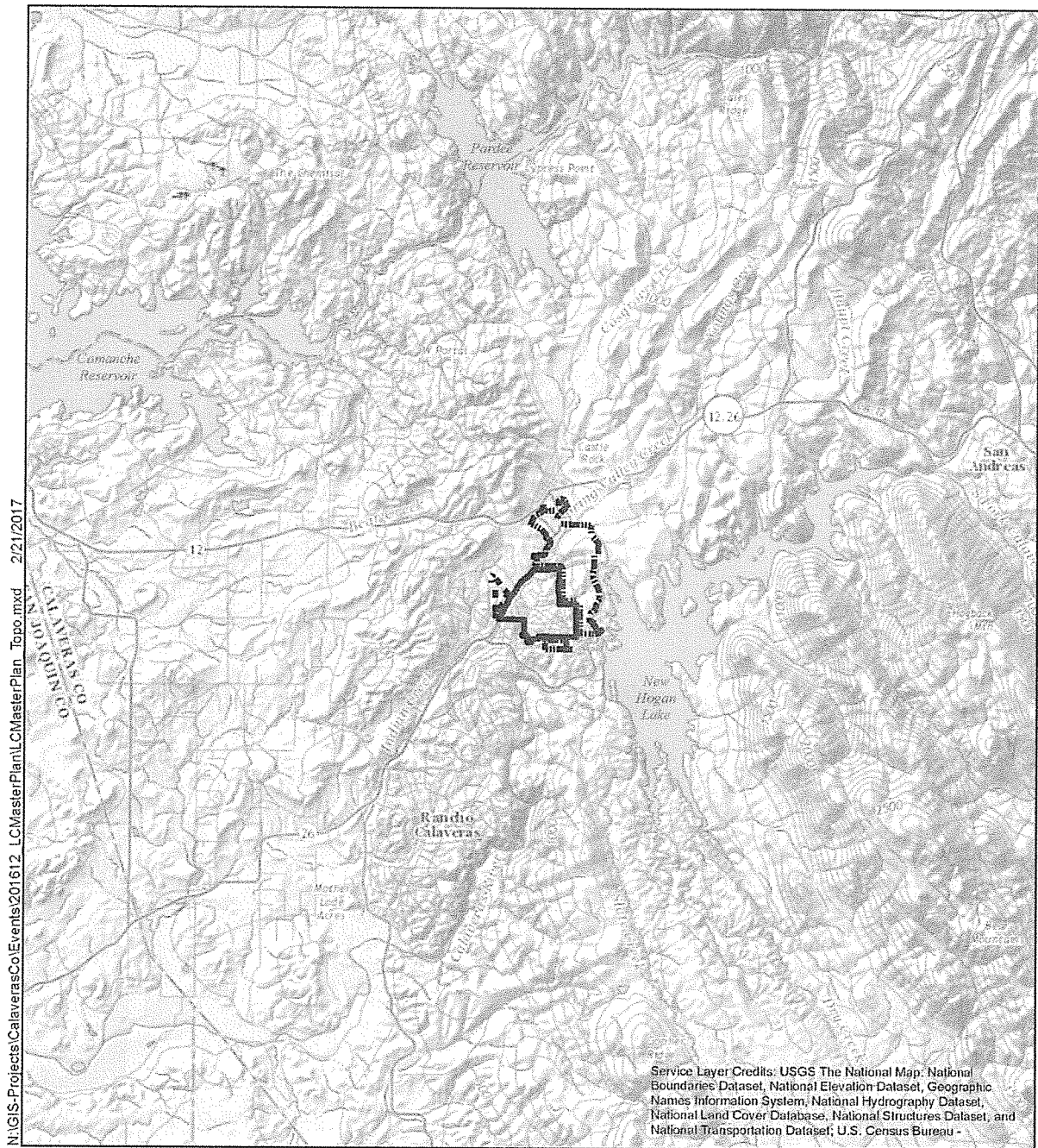

Elevated levels of salinity and nitrates in surface water and groundwater are impacting California, as well as other arid regions around the world. The LCWWS is located in a region where a salt and nutrient management plan is being prepared by the Central Valley Salinity Alternatives for Long-Term Sustainability (CV-SALTS), an organization sanctioned by the Central Valley Regional Water Board (CCWD, 2012). CCWD is a member of CV-SALTS.



N:\GIS-Projects\CalaverasCo\Events\201612_LCMasterPlan\LCMasterPlan_Topo.mxd 2/21/2017

Legend

Service Area Boundaries

-  AD 604
-  La Contenta Lakes Development and Golf Club
-  Annexed Area

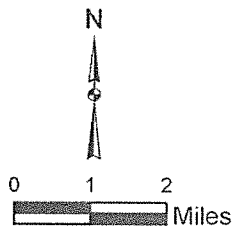

Kennedy/Jenks Consultants

Calaveras County Water District
La Contenta Wastewater System
Master Plan

Local and Regional Geography

Figure 6. Local and Regional Geography

Section 3: Evaluation of Existing Wastewater System

This section describes the existing collection, treatment, storage and disposal facilities that make up the LCWWS along with their rated capacities where applicable.

3.1: Collection and Conveyance

The following are descriptions of the existing sewer collection system and four lift stations that are currently used to convey wastewater from the service area to the LCWWTF for subsequent treatment and disposal.

3.1.1: Sewer Collection System

Altogether AD 604 is approximately 1,552 acres of which 703 acres are already sewered and 213 acres is non-sewered areas (e.g., open space, roadways). Futured sewered areas are estimated to total 636 acres. The collection system was originally constructed in 1980 to serve the La Contenta Lakes Development and the La Contenta Golf Course. The sewer collection system was expanded and extended to serve a larger service area through the addition of 6- through 18-inch gravity sewers, construction of a small lift station with a 6-inch forcemain and the Huckleberry Lift Station (HLS) with a 12-inch forcemain.

Currently, the collection system consists of 6 thru 18-inch gravity sewers, three minor (Warmwood, Woodgate and Highway 26 Lift Stations) lift stations and one main lift station (HLS) located on Huckleberry Lane, where the original wastewater treatment plant was located. Warmwood and Woodgate Lift Stations independently discharge wastewater into a common forcemain. Wastewater from the Highway 26 Lift Station is introduced into the forcemain, and this combined flow from the three minor lift stations, transitions into gravity flow and is conveyed through a grinder at the HLS. All wastewater flows are conveyed from the HLS to the LCWWTF.

Table 9 is a summary of existing collection system pipe diameter, approximate length, and materials of the construction obtained from CCWD's 2013 Report of Waste Discharge. At that time, CCWD staff estimated that the collection system pipelines had at least 20 to 40 years of remaining useful life.

Table 9. Summary of Existing Collection System

Diameter (inches)	Length (feet)	Material
6	74,850	PVC
8	5,350	PVC
10	6,850	PVC
12	5,450	PVC
15	1,200	PVC
18	300	PVC

Source: Report of Waste Discharge (CCWD, 2013).

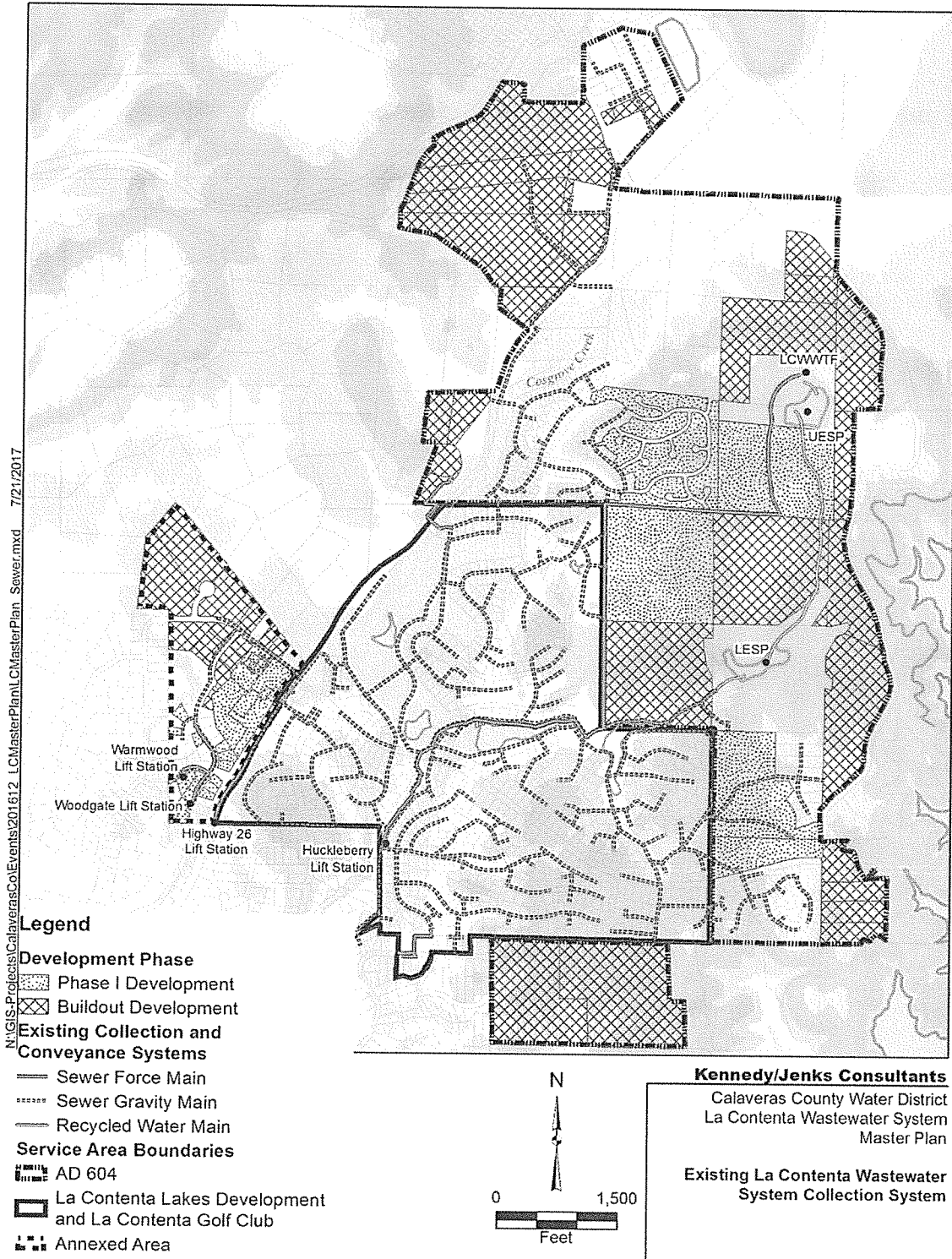

Figure 7. Existing La Contenta Wastewater System Collection System

3.1.2: Huckleberry Lift Station

HLS is located within a residential area adjacent to the previous site of the wastewater treatment plant and Cosgrove Creek on Huckleberry Lane. The station is equipped with a biofilter for odor control.

All wastewater within the LCWWS is pumped from the HLS wet well through a 12-inch diameter, 11,000-ft forcemain to the LCWWTF. The HLS has three³, 88 horsepower (HP) Flygt Model No. CP-3300-462 non-clog centrifugal submersible pumps and a 200 KW emergency standby power generator capable of powering any two of the three pumps. Figure 8 shows the system and cumulative pump curves developed by CCWD. As indicated, with one and two pumps out of service, the pumping capacities are estimated to be about 1,300 gpm (1.9 MGD) and 870 gpm (1.3 MGD), respectively.

The HLS wet well is relatively small and pumping up the hill to the LCWWTF is reportedly an operational challenge. The pumps cycle on and off frequently and deliver influent flows in pulses to the LCWWTF, which is problematic for many of the unit processes (i.e., screening, aeration, clarification, filtration and disinfection). As indicated in Figure 8, approximately 53 to 58 percent of the total dynamic head is static lift, leaving little operating flexibility for the variable speed drives to vary flows. According to the record drawings, the lead pump is set to turn on when the water depth reaches 574.47, which equates to a wet well volume of 6,440 gallons, and turn off if the wet well water depth is drawn down to elevation of 571.47, which equates to a remaining volume of 3,220 gallons. A pump is estimated to operate a minimum of about 4 minutes to draw the wet well down based on these set points and no flow entering the wet well. However, if one pump is inadequate to keep up with influent flows, a second pump will be brought into service once the wet well water level reaches elevation 574.97, which equates to a volume of 6,980 gallons. The difference between pump starts and stops equate to a 3,760-gallon wet well operating volume. With two pumps in service, it is estimated that this wet well volume will require a little less than 3 minutes to be drawn down with no flow entering the wet well. Status and remote control of the lift station are available to CCWD staff via a SCADA system with alarms indicating wet well levels, pump failures, and power and generator status.

Figure 9 shows the boundaries of the FEMA Floodzones near the HLS. As shown, the HLS is located adjacent to Cosgrove Creek and within the FEMA Floodzone (Calaveras County, 2009).

³ Two of the three pumps are equipped with variable frequency drives (VFDs).

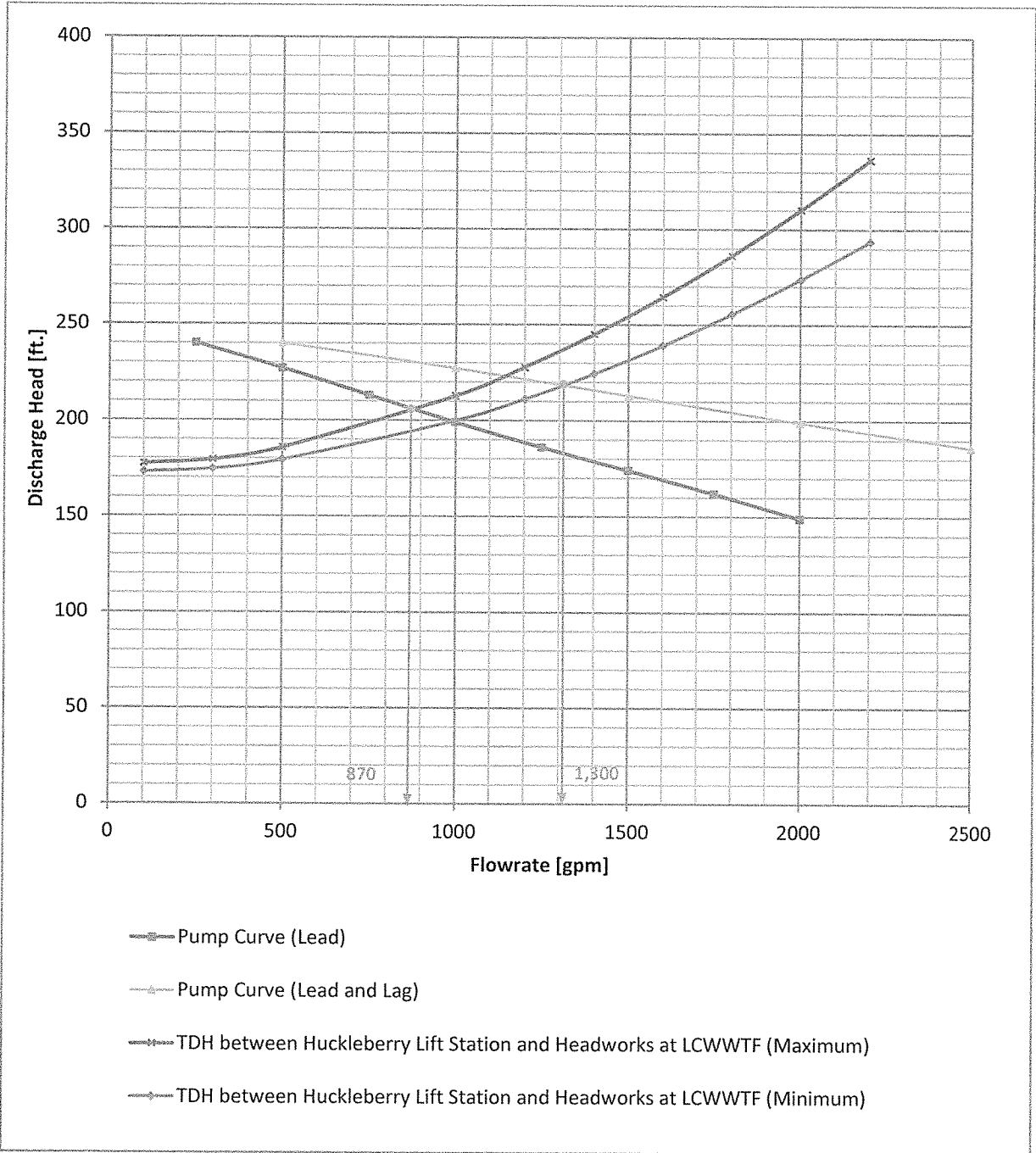

Figure 8. Huckleberry Lift Station System and Pump Curves

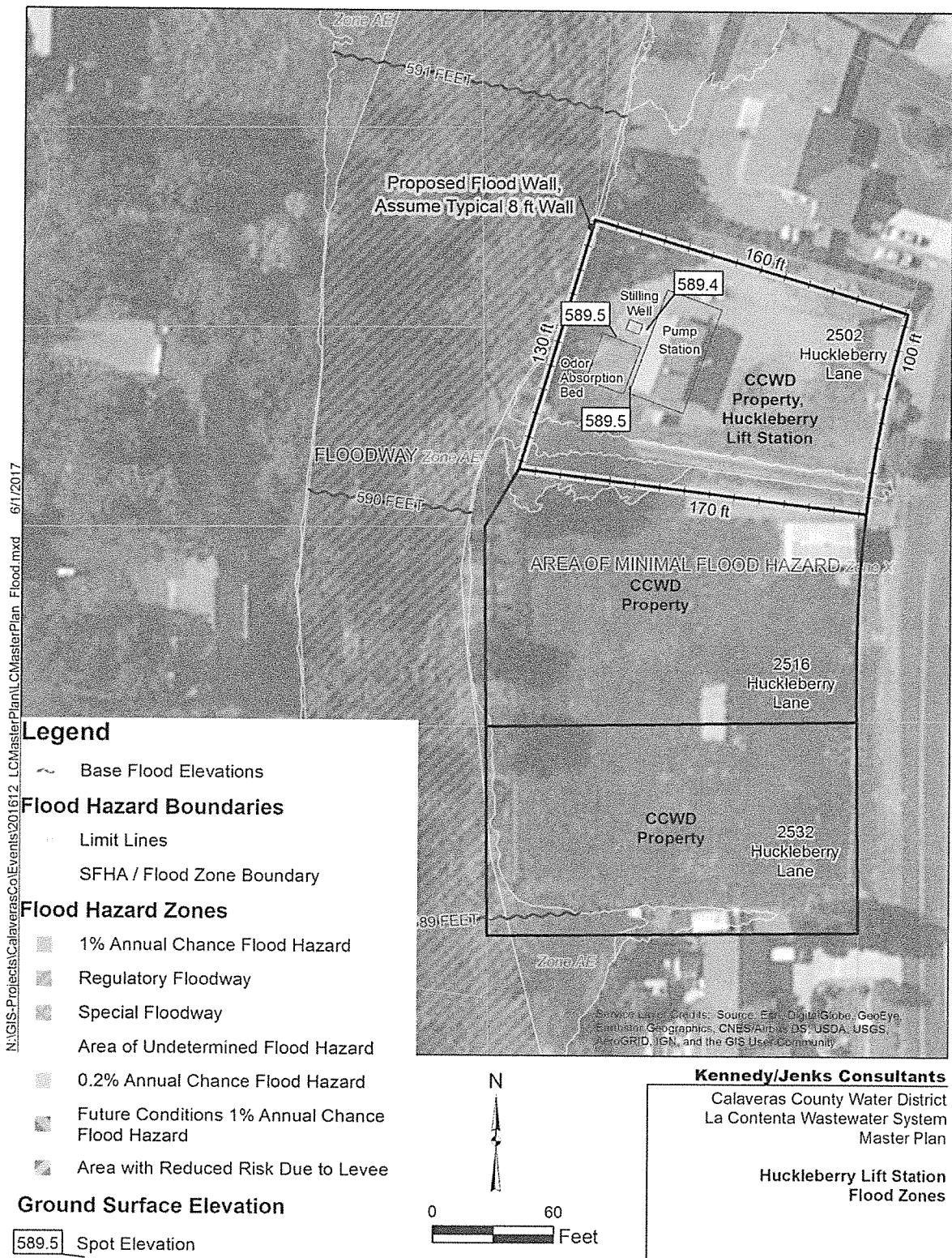

Figure 9. Huckleberry Lift Station Flood Zones

3.2: Wastewater Treatment Facility

The LCWWTF was originally built in 1991 and currently consists of a headworks, activated sludge process, tertiary filtration, ultra-violet light (UV) disinfection, sludge storage lagoon and belt filter press. As previously described, the LCWWTF is permitted to operate under the SWRCB General Waste Discharge Requirements for Landscape Irrigation Uses of Recycled Water (Water Quality Order No. 2009-0006-DWQ). According to the April 9, 2013 Report of Waste Discharge, the LCWWTF has a rated ADWF capacity of 0.2 MGD.

A summary of existing unit treatment processes, criteria governing the unit's capacity, and current loading conditions is presented in Table 10. A site plan and process flow schematic of the LCWWTF are shown in Figure 10 and Figure 11, respectively.

3.2.1: Influent Screening

Raw wastewater influent to the LCWWTF is continuously screened to remove material, grit, debris, floatable material, etc. that might otherwise damage or promote solids deposition in downstream processes and/or equipment. Screening facilities are located under the breezeway of the operation building and consist of the following:

- 12-inch Parkson Aqua Guard mechanical screen with 15 mm (5/8-inch) clear openings; direct discharge of screenings into a wheelbarrow. Typically, this screen is in operation.
- Fixed bar rack manually cleaned bar screen with ½-inch clear openings, in an 18-inch bypass channel that serves as backup to the mechanical screen.
- 18- to 24-inch screening channel width, 18-inch maximum water depth, with 12-inch inlet and outlet piping.
- Configured for future expansion (i.e., second channel to serve second treatment train).

The screen was originally thought to have a rated design capacity of 4 MGD. However, channel design and screen operations limitations are noted as follows:

1. Channel inlet and outlet configuration limit the screen capacity to well below the reported 4 MGD capacity
2. Operations staff report that a significant amount of material pass through the relatively large/coarse screen openings.
3. Operations staff report that screenings that accumulate in the wheelbarrow are wet, odorous, include organic material, and are a nuisance to handle.
4. Recent discussions between the manufacturer (Parkson) and CCWD staff on December 1, 2016 indicate that the screen brushes may not operate properly, which is critical for this particular screen type and model. Parkson to send local representative to the site to view the screen, make sure the brushes are installed and operating correctly, and provide follow up training, if needed.

Table 10. Unit Processes, Governing Criteria and Operating Conditions

Facility and/or Unit Process	Governing Criterion or Criteria	Units	Operating Conditions, gpm		Rated Capacity		Notes
			Current	At Capacity	% Loaded	MGD (PWWF)	
Huckleberry (Main) Lift Station	Pumping capacity with largest unit out of service	3, 88 HP Flygt CP-3300 462 submersible pumps, two variable and 1 constant speed pumps. Wet well volume between 3,220 and 6,980 gallons	653	1,300	50.0	1.9 (PWWF)	Based on January 10, 2017 PWWF operating data
	Wet well volume, no more than 10 pump starts/hour	Wet well volume between 3,220 and 6,980 gallons. Approximately 1,074 gallons/foot of wet well depth	7 starts/hr	10 starts/hr	70	1.3 (PWWF)	Current operating conditions based on La Contenta Master Plan (February 2003); At Capacity flow based on March 3, 2016 Engineering Committee Presentation
Headworks (Rotary Barscreen)	Mechanically cleaned barscreen w/direct discharge into wheelbarrow	5/8-inch Parkson AquaGuard mechanically cleaned barscreen; 1/2-inch manually cleaned bar screen	652	694	94	4.0 Rated / 1.0 Actual (PWWF)	Based on January 10, 2017 PWWF operating data. Requires new brushes
	Fixed bar rack (bypass channel)	1/2-inch manually cleaned bar screen (bypass)	na	na	na	na	Serves as backup to mechanically cleaned screen in 18-inch bypass channel
Aeration Basin							
Parkson Biolac™	Hydraulic Retention Time, ADWF, 24 to 48 hours recommended	500,000 gallon aeration basin	97	174	56	0.3	
Parkson Biolac™ Integral Clarifier	Surface Overflow Rate, ADWF	100,000 gallon integral clarifier	97	139	70	0.2	1,000 gpd/sf per Parkson, District staff indicate lower capacity
Tertiary Filters (Parkson DynaSand)	Maximum Hydraulic Loading Rate (5 gpm/sf) with one unit out of service (assumed to be equivalent to Maximum Day Conditions)	5 units, each unit 50 sf, continuous backwash sand filters	305	1,000	31	1.4	Maximum day or peak wet weather flow
UV Disinfection	Capacity with 1 module in standby and 55% UVT. Per Checkpoint Bioassay Results (May 2012)	4 Trojan UV3000 Plus banks - 4 modules per bank, 6 lamps per module	97	465	21	0.7	Reflects capacity described in Checkpoint Bioassay Results for the Trojan UV3000 PLUS™ Systems at the La Contenta and Copper Cove WRPS (May 2012)
	Capacity with all but 1 bank in standby mode and 65% UVT. Per Checkpoint Bioassay Results (May 2012)	4 Trojan UV3000 Plus banks - 4 modules per bank, 6 lamps per module	549	889	62	1.3	
Upper Effluent Storage Pond Lower Effluent Storage Pond	Adequate storage to accommodate 100-yr levels of annual precipitation	49 acre-ft storage capacity (w/2 ft freeboard) 172 acre-ft storage capacity (w/2 ft freeboard)	195 acre-ft	221 acre-ft	88	0.23	Based on water balance results reported in Table 3 of the April 9, 2013 Report of Waste Discharge
	Effluent disposal at agronomic rates	197 acre-ft per year, average conditions and 233 AFY, 100-yr conditions	233 AFY	233 AFY	100	0.20	Limits overall capacity of wastewater system. ADWF to be determined by the total flow for the months of July through September, inclusive, divided by 92 days in accordance with the current order (RS-2013-0133)
Sludge Storage Lagoon	Hydraulic Retention Time, maximum month	125,000 gallon lagoon, 4 to 10 ft depth. Holiday weekend storage (4-day). Assumed 1 % TS	3,903	> 4 days	0.1	> Buildout	May require replacement as routine part of Repair and replacement
Belt Filter Press	Feed Rate, gpm/meter and operating schedule	2 meter Ashbrook Simon Hartley belt filter press; 50 gpm/meter 100 gpm maximum, 2,080 hours/yr operation maximum	134	2,080 hr/yr operation	6	> Buildout	May require replacement as routine part of Repair and replacement

THIS PAGE INTENTIONALLY BLANK

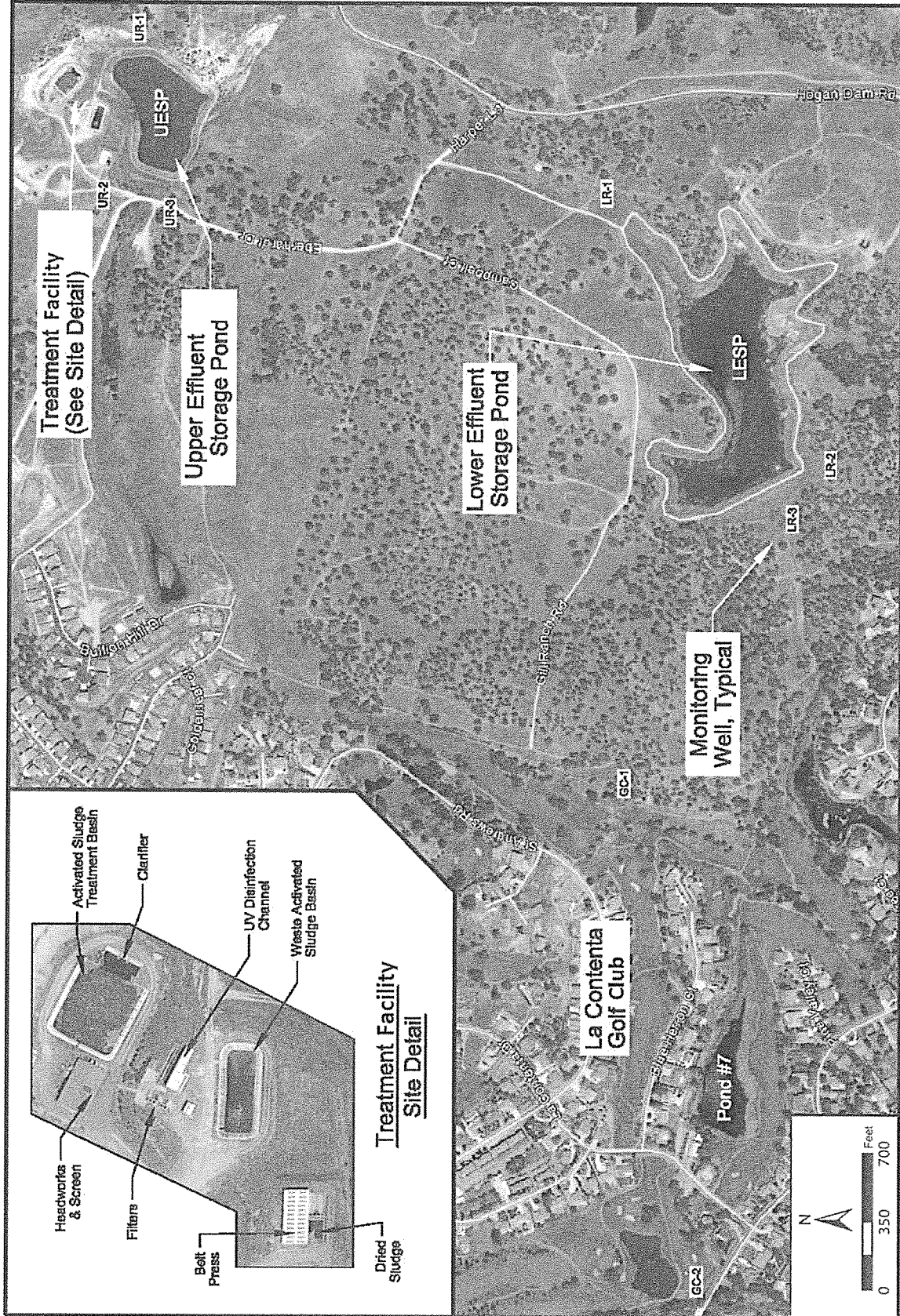

Figure 10. La Contenta Wastewater Treatment Plant Site Plan

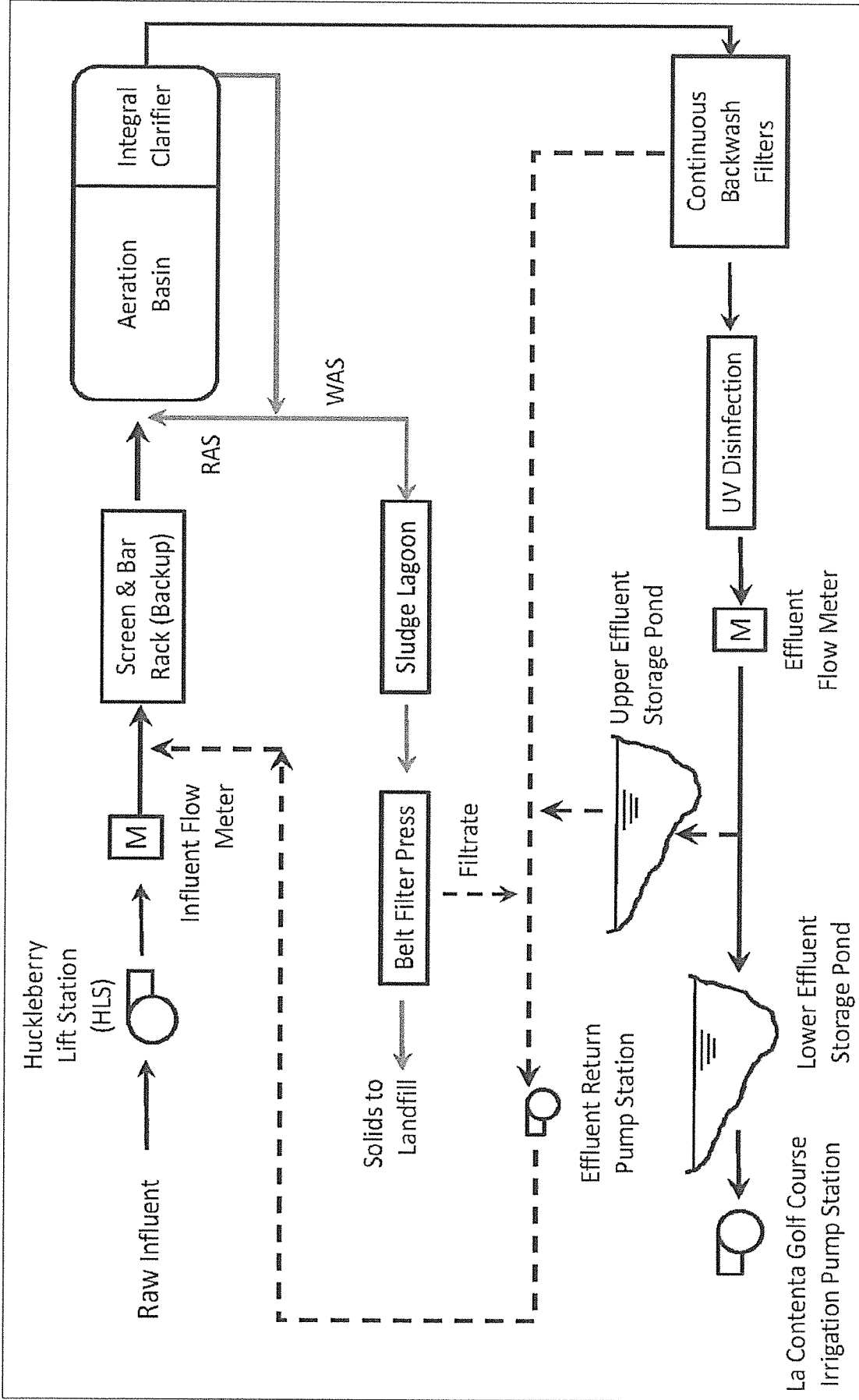

Figure 11. La Contenta Wastewater Treatment Plant Process Flow Schematic

3.2.2: Activated Sludge Process

Biological conversion of wastewater organics (i.e., BOD₅ and ammonia) at the LCWWTF is accomplished in the activated sludge treatment process. Process components include a 500,000-gallon concrete lined activated sludge aeration basin with aeration air blowers, aeration diffuser system, integral clarifier compartment within the aeration basin, and an airlift return activated sludge (RAS) and waste activated sludge (WAS) pumping system. Process design and structure configurations are part of the proprietary Biolac™ treatment system supplied by the Parkson Corporation.

The LCWWTF activated sludge process is designed to operate in the extended aeration activated sludge process mode. Key design characteristics of the Biolac™ system are described below:

- Concrete lined aeration basin, volume of 500,000 gallons, providing a hydraulic detention time of between 24 and 48 hours under ADWF conditions. Based on this criterion alone, the rated ADWF could be 0.25 to 0.5 MGD. Recent discussions with Parkson indicate that the rated ADWF capacity could be equivalent to Phase 1 development projections or 0.26 MGD.
- Three 592 cubic feet per minute (cfm) positive displacement air blowers with 25 HP constant speed motors, any two of which provide sufficient aeration and mixing within the aeration basin.
- An air distribution system consisting of 7 floating aeration chains, each with 6 sub-assemblies. Each sub-assembly currently has 3 diffuser tubes for a total of 126 fine bubble diffusers. Parkson indicated that additional aeration capacity and modes of operation are available to improve performance and/or capacity.
- Rectangular, lateral-flow integral clarifier integral within the aeration basin structure with floating inlet baffle (curtail), 1,000 square foot quiescent settling zone, and 40 foot long surface effluent launder.
- Airlift RAS and WAS pumping system.

Identified or reported operational concerns, control deficiencies, etc. are described below:

1. Repair of aeration distribution piping, hoses, and diffusers is more frequent than desired and is a safety risk involving taking a boat in the aeration basin while in operation.
2. The curtain baffle between the aeration basin and the integral clarifier has required repair, which cannot be accomplished easily without taking the aeration basin out of service.
3. No effective means of controlling the RAS and WAS pumping rate is provided other than the valve adjustment of the air flow to the pump, which in turn affects air flow balance amongst diffusers.
4. Flow meters are not provided for either the RAS or WAS systems which would allow operators to more accurately monitor and adjustment to optimize process performance.
5. LCWWTF standby power generator apparently can only run one aeration blower, which can reportedly accommodate flows of about 0.2 to 0.25 MGD.

3.2.3: Tertiary Filtration

As described in Table 10, the LCWWTF includes five Parkson Dynasand continuously backwash sand filters (50 square foot per filter cells; 250 square foot total). The filters are provided to reduce secondary effluent TSS concentrations and turbidities to accommodate UV disinfection and comply with Title 22 regulatory requirements.

Alum and polymer chemical feed systems are provided to enhance filter removal of particulates if needed for regulatory compliance. Each system consists of a 400-gallon tank with propeller mixer and two diaphragm pumps. Either or both chemicals can be applied through injector ports upstream of an in-line static mixer in the secondary effluent pipeline ahead of the filter distribution manifold. Chemical feed rate is set manually.

Filter average hydraulic and solids loadings to date have been sufficiently low such that chemical addition has not typically been necessary to enable downstream disinfection effectiveness.

3.2.4: Disinfection System

Filtered effluent is subjected to UV disinfection by a Trojan 3000 Plus UV light open channel disinfection system. The system was installed in 2009 and consists of 3-duty/1-standby banks with 4-modules per bank and 6-lamps per module (24-lamps per bank and 96 lamps total). The UV system was validation tested in November 2012.

3.2.5: Chlorine Contact Basin (Currently Out of Service)

Prior to installation of UV disinfection, disinfection was achieved through the addition of hypochlorite and detention in a chlorine contact basin. The chlorine contact basin, which is currently out of service, is 20,850 gallons. The basin has 3 channels, each 4-foot wide, 160-foot long and 4.5-foot deep. The basin is located about 12 feet southeast of the tertiary filters.

3.3: Treated Effluent Storage and Beneficial Reuse/Disposal

The following are descriptions of existing treated effluent storage and beneficial reuse/disposal components within the LCWWS. The rated capacities of these facilities were also assessed in Table 10.

3.3.1: Treated Effluent Storage Ponds

The LCWWS has two treated effluent storage ponds, the Lower Effluent Storage Pond (LESP) and Upper Emergency Storage Pond (UESP). The LESP has a capacity of 172 acre-foot (ac-ft) (with 2 ft freeboard) for storage of treated effluent / recycled water through the wet months. During the dry months, recycled water is conveyed to the La Contenta Golf Course for irrigation during the subsequent spring, summer and fall months.

The UESP is located adjacent to the LCWWTF and has a capacity of 49 ac-ft (at 2-ft freeboard) and is used for emergency storage for peak flows or when treated effluent quality does not meet Title 22 recycled water standards. Treated effluent stored in the UESP is not discharged to the LESP; all wastewater is returned to the headworks and subsequently retreated.

3.3.2: La Contenta Golf Course

Recycled water stored through the wet season is used to irrigate the La Contenta Golf Course during the spring, summer and early fall seasons. Currently, recycled water deliveries using the 8-inch pipeline are limited to about 900 gpm.

Recycled water is delivered to Pond #7 at the La Contenta Golf Course. Recycled water deliveries and Pond #7 are operated such that recycled water is only delivered during the irrigation season and discontinued through the wet months. Since Pond #7 has a large catchment area, the pond fills during the rainy season and can naturally overflow into Cosgrove Creek, an ephemeral stream, which then flows to the Calaveras River below New Hogan Dam. To eliminate unpermitted discharges, recycled water is purged from Pond #7 each fall and its volume (25.8 ac-ft) are turned over with raw water before overflows can occur into Cosgrove Creek. Once the delivery of recycled water is discontinued, the La Contenta Golf Course Pond #7 irrigation pumps will continue to draw commingled recycled and raw waters from Pond #7 (downstream end) while raw water is delivered to the upstream end of the pond via the gravity ditch.

3.4: Biosolids Storage and Disposal

Waste activated sludge is stabilized, dewatered and temporarily stored, uncovered on-site before being hauled to a sanitary landfill and/or Synagro for land application as Class B biosolids at Silva Ranch in Herald, CA. Resulting filtrate and waste wash water from the belt press drains to the LCWWTF's return lift station and is pumped back to the headworks for treatment.

3.4.1: WAS Storage Lagoon

WAS from the activated sludge process is pumped to a 125,000-gallon concrete-lined lagoon for storage and stabilization prior to belt filter press dewatering. The sludge lagoon is constructed with a sloped floor to a submerged sump, with air diffusers to maintain mixing during sludge withdrawal from a bottom outlet pipe. A manually adjustable overflow outlet enables return of filtrate to the LCWWTF via the return lift station.

Wasting from the activated sludge process is achieved by manual opening of a valve in the discharge piping of the RAS airlift pumping system. The only means of controlling the wasting rate is by varying the duration and/or the frequency of the valve being opened. This means has been problematic in the past and leads to inconsistent wasting and variable mean cell residence times.

Solids separation in the lagoon is reported to be only marginally effective, as floating sludge accumulates at the shallow end of the basin. This requires personnel to manually rake or plow this material to the deep withdrawal end. No provisions are made to enable safe entry into the lagoon basin for cleaning.

3.4.2: Solids Dewatering

After WAS is stabilized in the lagoon it can be conveyed to the belt filter press (BFP) for dewatering. Prior to dewatering, the biosolids are chemically conditioned with an emulsion polymer flocculent that helps form stronger flocs. Within the BFP, biosolids go through preliminary dewatering where free water drains by gravity, then along the belt, ploughs to help water drain. Biosolids are then compressed between two belts and squeezed by rollers that move under and over to force any remaining excess water out.

The LCWWTF also has four existing, 600 square foot sludge drying beds which are no longer in service.

THIS PAGE INTENTIONALLY BLANK

Section 4: Evaluation of Alternatives

This section describes the development, evaluation and comparison of alternatives to accommodate Phase 1 and Buildout developments. Alternatives were developed using the planning criteria described previously. Alternatives associated with Phase 1 and Buildout improvements to the following systems are discussed in this section:

1. Existing and Future Collection System Sewersheds
2. HLS Flow Pulsing Mitigation
3. Wastewater Treatment Facility
 - a. Influent Screening
 - b. Activated Sludge Process
 - c. Intermediate Clarifier
4. Treated Effluent Storage and Disposal

Calculations, meeting agenda and minutes, etc. associated with these efforts can be found in the appendix.

4.1: Collection and Conveyance Systems

All wastewater within the existing La Contenta Service Area is currently routed through the HLS which places a relatively high level of importance on this particular asset with respect to reliability (i.e., required to be in continuous service) and risk (i.e., within floodplain and close proximity to Cosgrove Creek and residential homes). From the HLS, all wastewater is conveyed to the LCWWTF.

As previously described, the capacity of the HLS is estimated to be 1,300 gpm (1.95 MGD). The estimated PWWF at Buildout is estimated to be 1,550 gpm (2.23 MGD) assuming all wastewater within the existing and future service area is routed to the HLS, which is unlikely to occur.

Improvements to both the collection and conveyance systems are required to meet future needs with respect to both PWWF and area served/collection system expansion requirements.

4.1.1: Recent Levels of Precipitation and Inflow/Infiltration Contributions

The 2016-2017 wet season was one of the wettest seasons of record. As shown in Table 11, a total of 45.8 inches of rain has been measured at the Pardee Camp Station (PAR)⁴ which is 111 percent of the level anticipated for a 100-year level of annual precipitation (41.4 inches per year).

⁴ Department of Water Resources – California Data Exchange (CDED, 2017).

Table 11. 2016-2017 Wet Season Precipitation Measurements

Month and Year	2016-2017 Wet Season Measured Precipitation (inches per month)	100-yr Annual Level of Precipitation (inches per month)	ADWF (AF/month)	AAF (AF/month)
March 2016	5.85	6.67	12.26 ¹	19.06
April	2.70	3.67	12.26 ¹	14.91
May	0.18	1.59	12.26 ¹	14.07
June	0	0.49	12.26 ¹	12.92
July	0	0.08	12.26	12.33
August	0	0.12	12.26	12.39
September	0	0.59	12.26	11.92
October	4.31	2.28	12.26 ¹	13.29
November	2.79	5.07	12.26 ¹	14.57
December	10.66	6.19	12.26 ¹	17.22
January 2017	9.58	7.67	12.26 ¹	26.5
February	9.73	6.96	12.26 ¹	24.53
Total	45.80	41.40	147.09	193.71

¹ Arithmetic average of 2016 ADWF (July-September)

Instantaneous flow measurements obtained from the HLS served as the basis for projecting Buildout PWWF. Data obtained from the HLS SCADA System from January 10, 2017, 10 PM through January 11, 2017, 12:20 AM (shown in Figure 12) served as the basis for estimating current and projecting future PWWF infiltration and inflow (I/I) contributions.

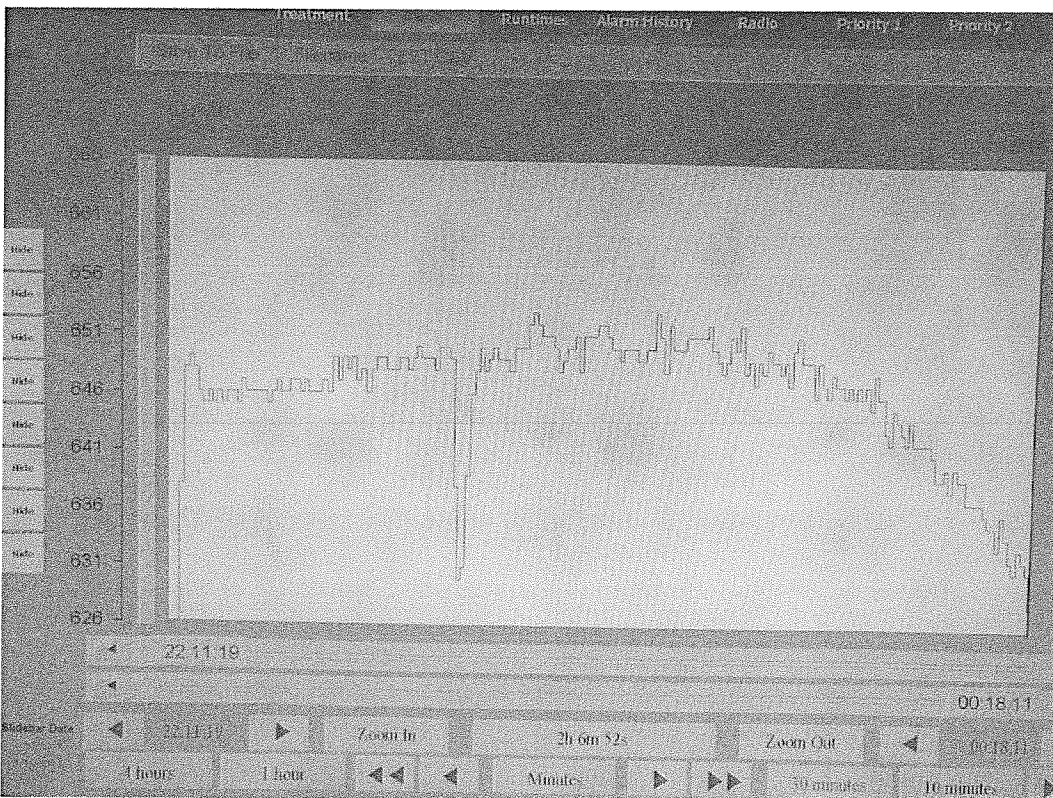

Figure 12. Instantaneous Flow Measurements (gpm) During Recent PWWF Event (January 10 and 11, 2017)

As shown in Figure 12, highest recorded flow measured during the January 10 and 11, 2017 PWWF event was 655 gallons per minute (gpm), which is equivalent to 0.94 MGD.

Review of the historic records and derivation of the average annual and average dry weather flows during the 2016 – 2017 wet season presented in Table 11 indicate that annual I/I contributions represent about 46.6 acre-feet per year (AFY) (or roughly 24%) of the total annual wastewater flow of 193.7 AFY.

4.1.2: Existing and Future Sewersheds

The existing collection system service area is approximately 703 acres. Comparison of the highest recorded flow measured during the PWWF event of 0.94 MGD with the existing service area indicates that existing PWWF I/I contributions are on the order of 1,138 gallons per day per acre of sewerage area (gpd/acre).⁵

Service area topographic, future development locations, existing service area, etc. were reviewed and evaluated. The evaluation led to the recommendation that the service area be divided into the following lift station sewersheds described below and shown in Figure 13.

- **Huckleberry Lift Station Sewershed:** As shown in Figure 13, most of the area recommended for this sewershed has been developed and is limited to infill within the La Contenta Lakes Development, La Contenta Golf Course, annexed area, and 20 acres of future development located within the southeastern corner of AD 604 that is currently unnamed. This particular sewershed is anticipated to generally flow by gravity to the HLS, which is at elevation 592 ft, one of the lowest throughout the service area.
- **Future Major Sewershed / Lift Station:** As shown in Figure 13, all of the area recommended for this sewershed is future development or currently unsewered areas such as Hogan Oaks II, New Hogan Lake Estates, Old Golden Oaks, Mission Ranch, Hogan Oaks I and Gold Creek III, and 171 acres of future development that is currently unnamed. A future major lift station should be located such that wastewater from this future sewershed flows by gravity into the future major lift station wet well. Also, the potential to provide backup to the HLS could be considered during the siting of the new lift station.
- **Future Minor Sewershed / Lift Station:** As shown in Figure 13, development of Valley Springs Estates and Del Verde will require the installation of a future minor lift station. This station will be used to convey wastewater from the southwestern corner of Valley Springs Estates at elevation 650 ft over the relatively high terrain located in the northern end of the development at elevation 745 ft. At this point, wastewater is anticipated to flow by gravity to the HLS and/or new major lift station if so desired.

Assuming the sewersheds shown in Figure 13 are implemented, the PWWF to the HLS is projected to be 780 gpm (1.12 MGD) (including future minor lift station contributions) at Buildout, which is less than the station's existing capacity of 1,300 gpm (1.9 MGD).

⁵ [0.94 MGD (PWWF) – 0.14 MGD (ADWF)]/703 acres equal to 1,138 gpd/acre.

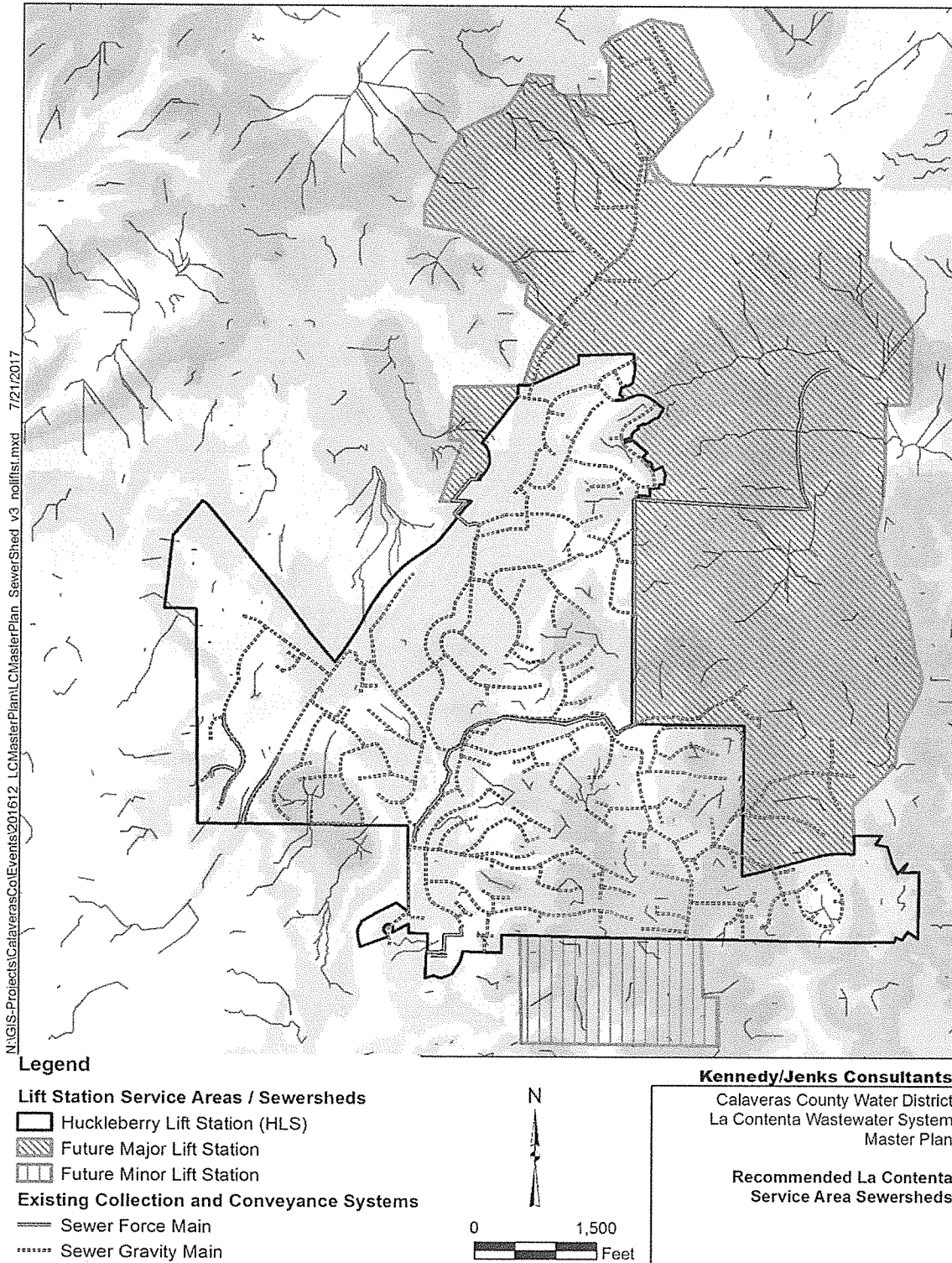

Figure 13. Recommended La Contenta Service Area Sewersheds

4.1.3: I/I and Future Flow Projections

At Buildout, an additional 636 acres are expected to be sewered. The projected PWWF of 1.9 or 2.0 MGD at Buildout was estimated by adding the projected future ADWF⁶ and PWWF I/I contribution⁷ to the current PWWF of 0.94 MGD.

4.2: Flow Pulsing Mitigation

The frequent cycling (turning on and off of pumps) at the HLS during periods of low flow has been reported to cause the delivery of raw wastewater to pulse or fluctuate rapidly. Depending on the severity, delivery of raw wastewater to the LCWWTF in this fashion may be detrimental to the performance of certain unit processes (e.g., activated sludge aeration basin and intermediate clarifier, tertiary filters and UV disinfection) and result in the higher potential for permit violations. It is recommended that the frequent cycling of pumps be reduced and/or eliminated if possible. The following alternatives were considered and discussed with District staff:

- **Alternative 1. Installation of Smaller (Jockey) Pump at Huckleberry Lift Station:** According to District staff, the minimum pumping rate of one of the two existing variable speed pumps is 400 gpm. A smaller pump, with a capacity on the order of 125 to 190 gpm, could be installed and used during low to moderate flow periods. Implementation of this alternative is expected to reduce power requirements due to increased pump efficiency.
- **Alternative 2. Flow Equalization at LCWWTF:** Flow data associated with the January 2017 peak flow event were reviewed and analyzed to estimate the volume of equalization needed to attenuate instantaneous flows measured at the HLS to 400 gpm (flow characterized by the current maximum day condition or capacity of one of the existing pumps). Analysis results indicate that a minimum of approximately 52,000 gallons of storage would be required⁸. This volume of equalization could likely be placed at either the HLS and/or LCWWTF sites. Locating equalization at the LCWWTF site would likely be less problematic than at the HLS site given that it is located within a residential neighborhood and would require the installation of lower horsepower pumps. In addition, the addition of equalization at the LCWWTF could be phased to serve as flow equalization post Phase 1 and a second Biolac™ train post Buildout.

Costs associated with Alternative 1 are anticipated to be significantly lower than Alternative 2 plus improve operation. Future peak wet weather flows to the HLS are projected to increase by about 20 percent, which will likely reduce pump cycling during low flow periods. Given these considerations and relative advantages, Alternative 1 is recommended.

4.3: Wastewater Treatment Facility

The following are descriptions of the alternatives to improve the existing LCWWTF unit processes. Descriptions of the rationale used for the development of other unit process/facility improvements are also described in this section.

4.3.1: Influent Screening

The existing mechanical screen is approximately 25 years old and was placed into service in the early 1990s when the LCWWTF was initially started up. The anticipated useful life of mechanical

⁶ (0.45 or 0.39 – 0.14 = 0.31 or 0.25 MGD)

⁷ (636 acres x 1,138 gpd/acre = 0.72 MGD)

⁸ Approximate space requirements are 700 ft² based on assumed 10 ft depth

equipment, such as the Parkson AquaGuard, is typically 20 to 30 years of service depending on application, frequency of operation, etc.

Replacement of the influent screen is recommended to occur in Phase 1 due to age along with review of its condition and performance. Furthermore, it is recommended that (a) the condition of the screen, in particular the brushes, be reviewed by Parkson field representative as soon as possible and (b) the capacity of two new screens accommodate the projected Buildout PWWF. The existing screen would be replaced with a new unit in Phase 1; second unit installed at Buildout. It has been assumed that both screens would be located within or near the existing breezeway and/or channels and thus concrete and site improvements would be minimized.

Screenings are assumed to continue to be dumped directly into a wheelbarrow after Phase 1. However, as the service area expands, the desire and/or need for screenings washing and compacting and/or odor control will increase. To address this potential future need, it is recommended that addition be included and budgeted for along with the addition of a second screen for Buildout.

Manufacturers and manufacturer representatives were contacted to discuss the existing screen and appropriate technologies for replacement. The following are descriptions of the two types of screens considered for the LCWWTF:

- Alternative 1. Parkson AquaGuard (Replace In Kind)
- Alternative 2. Inchannel Fine Basket Screen with Integral Compactor/Dewatering Unit

Discussion and comparison these types of screens with District staff led to selecting Alternative 1 for budgeting purposes at this time (represents the highest cost). Given that this decision does not have to be implemented today and the fact that screening technology will continue to evolve over time, it is recommended that this selection be reevaluated during the preliminary design stage.

4.3.2: Activated Sludge Process

Review of projected flows and loads and recent discussions with Parkson indicate that the capacity of the existing activated sludge process train (i.e., Biolac™ extended aeration basin and integral clarifier) can accommodate Phase 1 requirements through the implementation of specific aeration and integral clarifier improvements described later in this section. Comparison of the increased flow capacity to projected flows and loads indicates the need for a second Biolac™ train⁹ to accommodate the level of development projected for Buildout or earlier if the existing train cannot accommodate 0.26 MGD. Although activated sludge process alternatives to Biolac™ exist, the operation of this type of system requires a Grade 3 license as compared to Grade 5 for a conventional activated sludge process. In addition, the level of complexity and monitoring is substantially less for Biolac™ than for conventional activated sludge process.

4.3.3: Intermediate Clarifier

The following alternatives were considered and discussed with District staff, Parkson and further reviewed and evaluated:

- **Alternative 1. Rehabilitate Existing Integral Clarifier.** Replace curtain with concrete baffle wall, replace RAS airlift system with pumped RAS system, replace skimmer with new

⁹ Or technology similar to Biolac™

technology and install RAS and WAS flow and TSS meters for process control. Consider competitors to Parkson.

- **Alternative 2. Enlarge and Reshape Existing Integral Clarifier.** Take Biolac™ system out of service and provide temporary treatment and/or storage for extended period of time (3 months minimum). Replace curtain with concrete baffle wall and extend width of existing integral clarifier by 10 ft maximum, reshape to reflect vertical as opposed to sloped wall, install latest technology relative to RAS withdrawal and conveyance, replace skimmer with new technology and install RAS and WAS flow and TSS meters for process control. Consider competitors to Parkson.
- **Alternative 3. Replace Existing Integral Clarifier with External Circular Clarifier.** Install new conventional 36-ft diameter circular secondary clarifier to replace existing integral clarifier. To minimize site improvements and costs, the new clarifier would likely be located near the existing standby generator and future location of the second Biolac™ train and require site piping and pumping improvements for mixed liquor and RAS conveyance.
- **Alternative 4. Consider Running Tertiary Filters in Series.** Currently there are five tertiary filters. Secondary effluent is currently routed through one tertiary filter then to the UV disinfection system. To improve solids removal and quality, secondary effluent could be routed through two tertiary filters operated in series. The existing chlorine contact basin could function as an intermediate wet well and pumps could be installed in the basin to provide this ability.

Discussions with CCWD staff lead to recommending Alternative 3. The ability to control the activated sludge process would be significantly improved, and the additional volume could be used to increase capacity.

4.4: Treated Effluent Storage and Disposal

The District developed a water balance for the Report of Waste Discharge which was submitted, reviewed and accepted by the RWQCB. This water balance was provided in electronic format and modified to reflect Buildout, then Phase 1 conditions. Modifications to the water balance were limited to the following:

- Preparation of Buildout, then Phase 1 water balances.
- Increase in ADWF to 0.45 MGD to reflect the highest projected ADWF at Buildout and unit flow factor of 195 gpd/ESFU. Likewise, Phase 1 water balance reflects the highest projected Phase 1 ADWF of 0.26 MGD.
- Increase service area I/I contributions to reflect the ratio of the future collection system area (1,339 acres) to the existing collection system area (703 acres).
- Increase inflow storage contributions to reflect the addition of a third 200 ac-ft storage pond with specific watershed (20 acres) and surface (17.2 acres) areas. These parameters reflect the average geometry associated with the existing Upper and Lower Effluent Storage Ponds.

- Increase irrigation demands from 233 to 567 AFY to reflect the addition of 100 acres of irrigable land. This land is assumed to be irrigated at an agronomic rate of 3.3 ft per year.

Table 12 presents a summary of the updated water balance results. Copies of the Phase 1 and Buildout water balances are included in the appendix for reference.

Table 12. Summary Water Balance Results – 100-year Level of Annual Precipitation

Condition	Storage Requirements (ac-ft)	Beneficial Reuse / Disposal Requirements (AFY)
Existing	221	233
Phase 1	281	433
Buildout	421	567

For the purposes of this master plan and the budgeting of future improvements, it has been assumed that treated effluent disposal for ADWFs in excess of 0.20 MGD¹⁰ would be accommodated through the purchase of additional land and installation of spray fields. Application rates for the future spray fields are assumed to be agronomic rates and 3.3 ft/year.

It is recommended that CCWD monitor the status of alternative treated effluent disposal methods such as indirect potable and direct potable reuse (IPR and DPR, respectively) which are more innovative, potentially more cost-effective and beneficial with respect to California's water supply.

4.4.1: Seasonal Storage Implications

It is recommended that incremental seasonal storage capacity be provided if possible through the expansion of the existing UESP or LESP and/or the addition of a new and expandable pond. Ideally the new pond would initially be configured to storage up to 80 or 100 ac-ft during extreme wet weather seasons. Later, likely after 10 to 20 years, the pond would be expanded to 200 ac-ft.

A minimum of 20 acres of additional land is required to accommodate the seasonal storage expansion. Actual seasonal storage land requirements will likely be 50 to 100 percent or greater (30 to 40 acres) based on actual site topography.

4.4.2: Treated Effluent Disposal / Beneficial Reuse

Projected Phase 1 and Buildout land requirements are summarized in Table 13 for average and 100-yr levels of precipitation. Projected land requirements are based on irrigation rates of 3.3 ft per year. As indicated in Table 13, a minimum of 100 acres of addition land, for a total of 170 acres of land being irrigated with recycled water at Buildout, is recommended. A minimum of 20 acres of additional land is required to accommodate the seasonal storage expansion. Actual seasonal storage land requirements will likely be 50 to 100 percent or greater (30 to 40 acres) depending on actual site topography.

A minimum of 120 acres of land is required to accommodate future seasonal storage and beneficial reuse/disposal improvements through Buildout. It is recommended additional land be included in the cost estimate as a contingency, therefore costs for land are to be based upon 150 acres of land which provides a 16 percent buffer.

¹⁰ Equal to the treated effluent disposal capacity of the La Contenta Golf Course.

Table 13. Estimated Phase 1 and Buildout Demands and Land Requirements

Condition	Minimum Area Requirements (acre)	Recommended Area (acre)	Estimated Demand (AFY)	
			Average Levels of Precipitation	100-yr Levels of Annual Precipitation
Existing	70	0	197	233
Phase 1	140	150	366	433
Buildout	190	220	479	567

4.5: Biosolids

Several medium to large wastewater treatment plants such as the Fairfield-Suisun Sewer District and Delta Diablo Sanitation District have installed or will be installed regional biosolids to energy projects in the near future. Others, such as the Central Marin Sanitation Agency and City of Roseville have installed or are in the process of installing plant-specific biosolids to energy facilities. Typically, these facilities process municipal wastewater sludge or biosolids in anaerobic digesters along with municipal solids waste (MSW) diverted from landfills such as fats, oils and grease (FOG), food and organics waste, animal manure and processing byproducts to produce increased amounts of methane gas. Benefits include alternative funding and grant opportunities; reduced capital, operating and carbon emissions and helping to meet statewide organic recycling mandates. It is anticipated that more facilities such as these will be required as future regulations limit or eliminate the ability to dispose of the lignocellulosic fraction of MSW and agricultural residue as well as forestry and forest product residue.

The opportunity exists for CCWD to potentially install a regional biosolids handling facility. Preliminary discussions with CCWD indicate that the primary objective of such a facility would be to reduce biosolids hauling and disposal costs for all CCWD wastewater facilities. Logistically, this goal could be achieved through the installation of a regional biosolids facility located at the LCWWTF that serves all CCWD wastewater facilities. However, work beyond the scope of the Master Plan would be required to estimate the (1) total quantities of sludge and biosolids produced by all CCWD wastewater facilities and (2) total sludge/biosolids hauling and disposal costs; develop (3) partnering and funding approach and (4) preliminary regional biosolids facility requirements, (5) associated conceptual level cost estimates; and (6) compare alternatives and provide recommendations and next steps.

THIS PAGE INTENTIONALLY BLANK

Section 5: Recommended Improvements and Implementation Schedule

This section describes the recommended collection and conveyance system, LCWWTF, and treated effluent storage and disposal improvements, implementation timeline and estimated costs.

5.1: Collection and Conveyance System

Figure 14 shows existing and proposed future sewer collection systems, sewersheds and lift stations. For the purposes of this Master Plan it has been assumed that developers will fund future collection system and lift station improvements, therefore cost estimates specific to these improvements have not been developed nor included in subsequent Phase 1 and Buildout cost estimates.

5.1.1: Huckleberry Lift Station

The following are summaries of recommended Phase 1 and Buildout improvements.

5.1.1.1: Phase 1 Improvements

The following improvements have been included in the recommended Phase 1, Immediate Improvements Project:

- Flood wall improvements (see Figure 9)
- Install small, 125 to 190 gpm, jockey pump to eliminate/reduce low flow pulsing; SCADA programming
- Concrete rehabilitation (\$25,000 allocation for spot repairs)
- Replace 6-inch flow meter segment with larger 12-inch diameter segment and assess control/hydraulic impacts
- Replace existing grinder rail system with 2 rail system, purchase new grinder, and keep on shelf
- Replace three existing pumps

5.1.1.2: Buildout Improvements

Capacity requirements expected to be less than rated firm capacity of existing HLS. No expansion required, only routine maintenance and rehabilitation.

5.2: Wastewater Treatment Facility

Recommended Phase 1 and Buildout improvements are described below:

Phase 1 Improvements, Immediate Improvements:

- Replace existing mechanical screen with 1.0 MGD (minimum) unit. Plan for addition of second screen (also with 1.0 MGD minimum capacity) to accommodate projected Buildout PWWF of 2.0 MGD with new manual bar rack for backup installed immediately behind second screen

Phase 1 Improvements, Near-Term Improvements:

- Activated Sludge Process replacement of existing equipment
- New external circular secondary clarifier (Alternative 3 as described in Section 4.3.3)
- Increase UV disinfection capacity

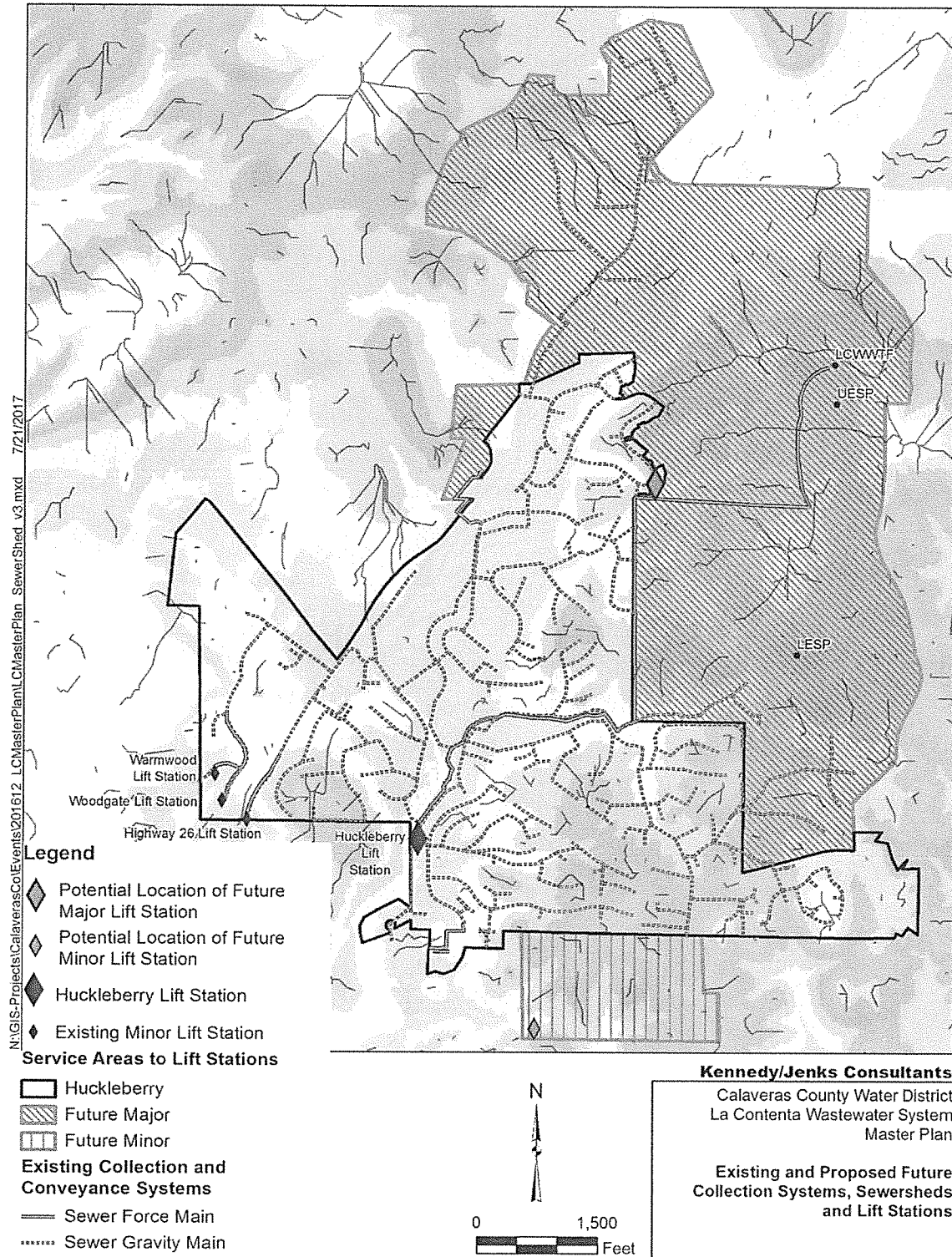

Figure 14. Existing and Proposed Future Collection Systems, Sewersheds and Lift Stations

Buildout Improvements:

- Add second Mechanic Screen and allocation to add (2) screenings washer/compactor units
- Add Second Activated Sludge Process Train¹¹
- Tertiary filter addition (only required if projected peak flows cannot be attenuated to projected maximum day flows)

5.3: Seasonal Storage and Treated Effluent Disposal / Beneficial Reuse

Future storage and disposal requirements were described previously in Table 12 and Table 13. Estimated land costs, without contingencies, soft costs or improvements for Phase 1 and Buildout are based on \$16,500 per acre cost and \$5,000 per acre for sprayfield system material costs.

5.4: Summary of Improvements and Estimated Costs

Table 14 and Table 15 are summaries of the recommended improvements and estimated costs.

Table 14. Recommended Near-Term and Phase 1 Improvements and Estimated Costs¹

LCWWS Component	Estimated Total Costs	Expansion	Repair and Replacement
NEAR-TERM IMPROVEMENTS			
HLS Improvements	\$510,000	\$80,000	\$430,000
LCWWTF – Screen (Replacement in Kind)	\$300,000	\$20,000	\$280,000
Construction Subtotal	\$810,000	\$100,000	\$710,000
Design Engineering (10%)	\$81,000	\$10,000	\$70,000
Legal/Administration (5%)	\$40,000	\$15,000	\$35,000
Construction Management (10%)	\$81,000	\$10,000	\$70,000
Total	\$1,015,000	\$125,000	\$885,000
PHASE 1 IMPROVEMENTS (1420 ESFUs; ADWF 0.20 MGD)			
Collection and Conveyance System	Developer Provided		
LCWWTF – Activated Sludge Process	\$1,400,000	\$1,400,000	\$0
LCWWTF – Integral Clarifier	\$1,540,000	\$1,540,000	\$0
LCWWTF – UV Disinfection	\$110,000	\$110,000	\$0
Construction Subtotal	\$3,050,000	\$3,050,000	\$0
Design Engineering (10%)	\$305,000	\$305,000	\$0
Legal/Administration (5%)	\$155,000	\$155,000	\$0
Construction Management (10%)	\$305,000	\$305,000	\$0
Total	\$3,815,000	\$3,815,000	\$0
PHASE 1 IMPROVEMENTS (1570 ESFUs; ADWF 0.23 MGD)			
Seasonal Storage and Disposal	\$2,445,000	\$2,445,000	\$0
Construction Subtotal	\$2,445,000	\$2,445,000	\$0
Design Engineering (10%)	\$245,000	\$245,000	\$0
Legal/Administration (5%)	\$125,000	\$125,000	\$0
Construction Management (10%)	\$245,000	\$245,000	\$0
Total	\$3,060,000	\$3,060,000	\$0

¹ Costs developed in June 2017 and reflect July 2017 Engineering News Record (ENR) 20-City Average Construction Cost Index of 10789.

¹¹ With external 50-ft diameter circular secondary clarifier.

Table 15. Recommended Buildout Improvements and Estimated Costs¹

LCWWS Component	Estimated Costs	Expansion	Repair and Replacement
Collection and Conveyance	Developer Provided		
LCWWTF – Second Screen and Washer/ Compactor Additions	\$535,000	\$535,000	\$0
LCWWTF – Second Activated Sludge Process Train	\$1,175,000	\$1,175,000	\$0
LCWWTF – New Clarifier Addition	\$1,540,000	\$1,540,000	\$0
LCWWTF – Tertiary Filters (if required)	\$265,000	\$265,000	\$0
Seasonal Storage and Disposal	\$1,290,000	\$1,290,000	\$0
Construction Subtotal	\$4,805,000	\$4,805,000	\$0
Design Engineering (10%)	\$480,000	\$480,000	\$0
Legal/Administration (5%)	\$240,000	\$240,000	\$0
Construction Management (10%)	\$480,000	\$480,000	\$0
Total	\$6,010,000	\$6,010,000	\$0

¹ Costs developed June 2017 and reflect July 2017 Engineering News Record (ENR) 20-City Average Construction Cost Index of 10789.

5.5: Implementation Schedule

Typically, a minimum of three years is required to complete projects similar in magnitude and scope to the recommended Phase 1 and Buildout Improvements. This timeframe assumes little to no environmental review requirements and limits the timeline to address this item to 6 months.

The LCWWS is currently being operated at about 70% of its rated ADWF capacity and future long-term growth rate is anticipated to be relatively small (less than or equal to 1 % per year), therefore it appears that a three-year timeline can be easily accommodated. The following is a recommended breakdown of major activities, sequence and estimated timelines to meet the three-year schedule.

- A. Preliminary and Detailed Design: 9 months
- B. Environmental and Regulatory Review: 6 months
- C. Advertisement and Bidding: 2 months
- D. Contractor Selection and Notice to Proceed: 1 month
- E. Construction: 12 months
- F. Startup, Commissioning and Close Out: 6 months

The Phase 1 HLS and screen improvements at the LCWWTF should be prioritized and implemented as soon as possible to improve performance, increase capacity. Phase 1 UV disinfection system improvements should be scheduled such that the peak/maximum flow routed through the existing UV disinfection system never exceeds 1.28 MGD with all modules in service.

It is also recommended that the District conduct water quality testing to measure pH and alkalinity and ensure their adequacy to support biological processes. In addition, CCWD should develop a repair and replacement for the LCWWS. At a minimum, assets with high consequences of failure should be assessed.

References

- Calaveras County. 2015 (November). Calaveras County General Plan Land Use Element. Planning Commission Recommendation. <<http://planning.calaverasgov.us/GeneralPlanUpdate.aspx>> Accessed February 13, 2016.
- Calaveras County Water District. 2016a (September). La Contenta Wastewater System Master Plan Kickoff Meeting Minutes. Prepared by Kennedy/Jenks Consultants. Rancho Cordova, CA.
- Calaveras County Water District. 2016b (March). La Contenta Wastewater Treatment Plant Update. Engineering Committee. Prepared by Calaveras County Water District. San Andreas, CA.
- Calaveras County Water District. 2013 (April). La Contenta Wastewater Treatment and Reclamation Facility Report of Waste Discharge. Prepared by Calaveras County Water District. San Andreas, CA.
- Calaveras County Water District. 2009 (January). Calaveras County Water District Design and Construction Standards. Prepared by Calaveras County Water District. San Andreas, CA.
- Calaveras County Water District. 2005 (April). Calaveras County Water District New Hogan/La Contenta Facilities Plan 2005 Update. Prepared by Eco:Logic Engineering, Rocklin, CA.
- Calaveras County Water District. 2003 (February). Calaveras County Water District New Hogan/La Contenta Wastewater System Facilities and Financing Plan. Prepared by Eco:Logic Engineering, Rocklin, CA.

THIS PAGE INTENTIONALLY BLANK

Appendix

Table A1. Water Balance for La Contenta Wastewater Treatment Facility - Buildout Conditions
 Calaveras County Water District / Master Plan - Buildout @ 195 gpd/ESFU / July 19, 2017

100-YEAR Month	Days	INFLUENT AND I&I			CLIMATE DATA				INFLOWS			OUTFLOWS				LESP			UESP			Volume Stored (ac-ft)						
		ADWF Flow (gpd)	ADWF Flow (ac-ft)	I&I Inflow (ac-ft)	Average Rainfall (inches)	Rainfall Distrib. (%)	100-Yr. Rainfall (inches)	Refer. ETo (inches)	Net Evap. (inches)	Net Precip. (inches)	Total Inflow (ac-ft)	Storage Evap. (ac-ft)	LESP Perc. (ac-ft)	UESP Perc. (ac-ft)	Accum. Volume (ac-ft)	Volume Stored (ac-ft)	Surface Area (acres)	Est. Level (ft)	Volume Stored (ac-ft)	Surface Area (acres)	Est. Level (ft)							
(1)	(2)	(3)	(4)	(5)	(6)	(7)	(8)	(9)	(10)	(11)	(12)	(13)	(14)	(15)	(16)	(17)	(18)	(19)	(20)	(21)	(22)	(23)	(24)	(25)	(26)	(27)	(28)	(29)
Oct	31	450,000	42.8	7.6	50.4	1.19	5.5%	2.28	3.72	1.81	0.00	50.4	0.00	50	1.0	0.36	0.37	13.8	0.0	0.0	15	33	5	16	0.0	0.0	0.0	2.0
Nov	30	450,000	41.4	15.2	56.6	2.65	12.3%	5.07	1.80	0.00	3.18	56.6	11.19	118	0.0	0.57	0.00	0.0	0.0	0.0	16	100	11	25	0.0	0.0	0.0	2.0
Dec	31	450,000	42.8	15.2	58.0	3.23	15.0%	6.19	0.93	0.00	5.21	58.0	16.33	194	0.0	1.23	0.00	0.0	0.0	0.0	17	170	15	29	5.3	3.4	1.6	2.0
Jan	31	450,000	42.8	15.2	58.0	4.00	18.5%	7.67	1.24	0.00	6.37	58.0	22.39	275	0.0	1.73	0.38	0.0	0.0	0.0	19	170	15	29	49.0	4.5	12.7	36.6
Feb	28	450,000	38.7	15.2	53.8	3.63	16.8%	6.96	1.96	0.00	4.90	53.8	17.23	346	0.0	1.73	0.51	0.0	0.0	0.0	21	170	15	29	49.0	4.5	12.7	105.4
Mar	31	450,000	42.8	15.2	58.0	3.48	16.1%	6.67	3.41	0.00	3.09	58.0	10.66	415	0.0	1.57	0.46	0.0	0.0	0.0	23	170	15	29	49.0	4.5	12.7	172.2
Apr	30	450,000	41.4	7.6	49.0	1.92	8.9%	3.67	5.10	1.94	0.00	49.0	0.00	464	3.2	1.73	0.51	14.5	0.0	0.0	43	170	15	29	49.0	4.5	12.7	201.2
May	31	450,000	42.8	0	42.8	0.83	3.8%	1.59	6.82	5.91	0.00	42.8	0.00	506	9.7	1.68	0.49	88.8	2.0	0.5	146	170	15	29	49.0	4.5	12.7	141.4
Jun	30	450,000	41.4	0	41.4	0.25	1.2%	0.48	7.80	8.09	0.00	41.4	0.00	548	13.2	1.73	0.51	121.5	2.7	0.4	286	170	15	29	49.0	4.5	12.7	43.1
Jul	31	450,000	42.8	0	42.8	0.04	0.2%	0.08	8.06	8.78	0.00	42.8	0.00	591	14.4	1.68	0.49	131.9	2.9	0.5	437	152	14	28	0.0	0.0	0.0	2.0
Aug	31	450,000	42.8	0	42.8	0.06	0.3%	0.12	7.13	7.73	0.00	42.8	0.00	634	9.1	1.61	0.00	116.0	2.6	0.5	566	65	8	21	0.0	0.0	0.0	2.0
Sep	30	450,000	41.4	0	41.4	0.31	1.4%	0.59	5.40	5.35	0.00	41.4	0.00	675	3.7	0.95	0.00	80.3	1.8	0.4	653	20	4	13	0.0	0.0	0.0	2.0
TOTALS	365		504	91	595	21.6	100%	41.4	53.4	39.6	22.7	595	80.0	675	54.2	16.6	3.7	567	12.0	2.3	653	20	4	13	0.0	0.0	0.0	2.0

Service Area Sewersheds	
	Acres
Existing	707
Future	632
Unsewered	213
Total	1,552

Storage Pond Areas and Capacities			
	LESP	UESP	FSP A
Surface Areas	14.5	4.5	17.2
Catchment Areas	17.2	5	20.0
Storage Capacities	172	49	200
FSP A = Future Storage Pond A			
TOTAL			42.1

FOOTNOTES:

- (5) Infiltration and inflow (I&I) estimated to be 48 ac-ft for 100-Year annual rainfall event and 25 ac-ft for average year rainfall. Future bulkhead I&I estimates based on 48 ac-ft x ratio of future service area (707 + 632) / existing service area (707).
- (6) Average rainfall of 21.5-inches for Camp Pardee (Station B20M).
- (7) Percent monthly rainfall distribution from Camp Pardee (Station B20 M) for average annual return period, e.g. for December 15% = 3.23-in + 21.6-in.
- (8) 100-Year annual rainfall of 41.38-inches for Camp Pardee Station multiplied by percentage (in Column 8) to obtain monthly distribution.
- (9) Standard annual and monthly reference evapotranspiration from CIMIS map for Zone 12.
- (10) For dry months, evaporation is greater than rainfall resulting in a net excess of evaporation, Net ET = ETo x Kc - Rainfall, using Kc = 1.1 for open water surfaces.
- (11) For wet months, precipitation is greater than evaporation resulting in a net excess of precipitation (such as runoff from catchment), Net Precipitation = Rainfall - ETo x Kc, using Kc = 1.05 for bare soil and open water surfaces.
- (12) Same as Column 6.
- (13) Net precipitation (Column 12) falling on the catchment areas of LESP and UESP.
- (14) Volume of accumulated inflows to storage equals sum of Columns 13 and 14.
- (15) Outflow from storage (LESP and UESP) due to evaporation off the water surface; water surface is calculated based on volume in each of the LESP and UESP. Storage Evap = (LESP Surface Area + UESP Surface Area) x Net Evap
- (16) Percolation from LESP into ground based on an assumed hydraulic conductivity of 1x10-6 cm/sec or 0.003685 ft/day. LESP Perc. = 0.003685 x Days x LESP Surface Area = 0.003685 x Column 2 x Column 24
- (17) Percolation from UESP into ground based on an assumed hydraulic conductivity of 1x10-6 cm/sec or 0.003685 ft/day. UESP Perc. = 0.003685 x Days x UESP Surface Area = 0.003685 x Column 2 x Column 24
- (18) Annual irrigation of 587 ac-ft recycled water based on 233-ac-ft per year demand for La Contenta Golf Course and the addition of 100 acres of land that can be irrigated at 3.3 ft/yr (agronomic rate)
- (19) Evaporation of recycled water from golf course Pond #7 based on pond surface area and net evaporation. Pond #7 Evaporation = Net Evaporation x 4.0 acres = Column 11 x 4.0 acres
- (20) Percolation from Pond #7 into ground based on an assumed hydraulic conductivity of 1x10-6 cm/sec or 0.003685 ft/day. Pond #7 Perc. = 0.003685 x Column 2 x 4.0 acres
- (21) Volume of accumulated outflows from storage sum of Columns 16 through 21
- (22) The required volume of storage is calculated by subtracting accumulated outflows from inflows; LESP is used to store Title 22 recycled water to a capacity of 172 ac-ft.
- (23)

Table A2. Water Balance for La Contenta Wastewater Treatment Facility - Phase 1 Conditions
 Calaveras County Water District / Waster Plan - Phase 1 @ 195 gpd/ESFU / May 1, 2017

100-YEAR YEAR	INFLUENT AND I&I				CLIMATE DATA				INFLOWS				OUTFLOWS				LESP				UESP				FSPA						
	ADWF Flow (gpd)	ADWF Flow (ac-ft)	I&I Flow (ac-ft)	I&I Flow (ac-ft)	Total Rainfall (inches)	Average Rainfall (inches)	100-Yr. Refer. Rainfall (inches)	100-Yr. Refer. ETo (inches)	Net Precip. (inches)	Net Evap. (inches)	Total Precip. (inches)	Total Inflow (ac-ft)	Storage Evap. (ac-ft)	UESP Evap. (ac-ft)	UESP Infiltration (ac-ft)	Pond #7 Evap. (ac-ft)	Pond #7 Perc. (ac-ft)	Accum. (ac-ft)	Volume Stored (ac-ft)	Surface Area (ac-ft)	Est. Level (ft)	Volume Stored (ac-ft)	Surface Area (ac-ft)	Est. Level (ft)	Volume Stored (ac-ft)	Surface Area (ac-ft)	Est. Level (ft)	Volume Stored (ac-ft)	Surface Area (ac-ft)	Est. Level (ft)	Total Storage (ac-ft)
(1) (2)	260,000	24.7	7.6	32.3	1.19	5.5%	2.28	3.72	1.81	0.00	32.3	1.0	0.36	0.37	10.4	0.0	12	16	3	13	0.0	0.0	0.0	0.0	0.0	0.0	0.0	0.0	0.0	0.0	20.2
Oct	30	260,000	24.7	7.6	32.3	1.19	5.5%	2.28	3.72	1.81	0.00	32.3	1.0	0.36	0.37	10.4	0.0	12	16	3	13	0.0	0.0	0.0	0.0	0.0	0.0	0.0	0.0	0.0	20.2
Nov	30	260,000	24.7	7.6	32.3	1.19	5.5%	2.28	3.72	1.81	0.00	32.3	1.0	0.36	0.37	10.4	0.0	12	16	3	13	0.0	0.0	0.0	0.0	0.0	0.0	0.0	0.0	0.0	66.4
Dec	31	260,000	24.7	7.6	32.3	1.19	5.5%	2.28	3.72	1.81	0.00	32.3	1.0	0.36	0.37	10.4	0.0	12	16	3	13	0.0	0.0	0.0	0.0	0.0	0.0	0.0	0.0	0.0	117.7
Jan	31	260,000	24.7	7.6	32.3	1.19	5.5%	2.28	3.72	1.81	0.00	32.3	1.0	0.36	0.37	10.4	0.0	12	16	3	13	0.0	0.0	0.0	0.0	0.0	0.0	0.0	0.0	0.0	171.2
Feb	28	260,000	24.7	7.6	32.3	1.19	5.5%	2.28	3.72	1.81	0.00	32.3	1.0	0.36	0.37	10.4	0.0	12	16	3	13	0.0	0.0	0.0	0.0	0.0	0.0	0.0	0.0	0.0	218.5
Mar	31	260,000	24.7	7.6	32.3	1.19	5.5%	2.28	3.72	1.81	0.00	32.3	1.0	0.36	0.37	10.4	0.0	12	16	3	13	0.0	0.0	0.0	0.0	0.0	0.0	0.0	0.0	0.0	263.7
Apr	30	260,000	24.7	7.6	32.3	1.19	5.5%	2.28	3.72	1.81	0.00	32.3	1.0	0.36	0.37	10.4	0.0	12	16	3	13	0.0	0.0	0.0	0.0	0.0	0.0	0.0	0.0	0.0	278.6
May	31	260,000	24.7	7.6	32.3	1.19	5.5%	2.28	3.72	1.81	0.00	32.3	1.0	0.36	0.37	10.4	0.0	12	16	3	13	0.0	0.0	0.0	0.0	0.0	0.0	0.0	0.0	0.0	221.7
Jun	30	260,000	24.7	7.6	32.3	1.19	5.5%	2.28	3.72	1.81	0.00	32.3	1.0	0.36	0.37	10.4	0.0	12	16	3	13	0.0	0.0	0.0	0.0	0.0	0.0	0.0	0.0	0.0	134.5
Jul	31	260,000	24.7	7.6	32.3	1.19	5.5%	2.28	3.72	1.81	0.00	32.3	1.0	0.36	0.37	10.4	0.0	12	16	3	13	0.0	0.0	0.0	0.0	0.0	0.0	0.0	0.0	0.0	44.5
Aug	31	260,000	24.7	7.6	32.3	1.19	5.5%	2.28	3.72	1.81	0.00	32.3	1.0	0.36	0.37	10.4	0.0	12	16	3	13	0.0	0.0	0.0	0.0	0.0	0.0	0.0	0.0	0.0	0.0
Sep	30	260,000	24.7	7.6	32.3	1.19	5.5%	2.28	3.72	1.81	0.00	32.3	1.0	0.36	0.37	10.4	0.0	12	16	3	13	0.0	0.0	0.0	0.0	0.0	0.0	0.0	0.0	0.0	0.0
TOTALS	365	291	91	382	21.6	100%	41.4	53.4	39.6	22.7	382	40.7	13.7	2.3	433	12.0	2.3	504.2	0	1	0	0.0	0.0	0.0	0.0	0.0	0.0	0.0	0.0	0.0	

Service Area Sewersheds		Storage Pond Areas and Capacities	
Existing	Future	LESF	UESP
707	632	14.5	4.5
Unsewered	213	17.2	5
Total	1,552	172	49
FSPA = Future Storage Pond A		FSPA = Future Storage Pond A	

Service Area Sewersheds	
Existing	Future
707	632
Unsewered	213
Total	1,552

FOOTNOTES:

- 100-year annual rainfall of 41.38-inches for Camp Pardee (Station B20M).
- Average monthly rainfall distribution from Camp Pardee (Station B20 M) for average annual return period, e.g. for December 15% = 3.23-in - 21.6-in.
- 100-Year annual rainfall of 41.38-inches for Camp Pardee Station multiplied by percentage (in Column 8) to obtain monthly distribution.
- Standard annual and monthly reference evapotranspiration from CIMIS map for Zone 12.
- For dry months, evaporation is greater than rainfall resulting in a net excess of evaporation. Net ET = ETo x Kc - Rainfall; using Kc = 1.1 for open water surfaces.
- For wet months, precipitation is greater than evaporation resulting in a net excess of precipitation. Net Precipitation = Rainfall - ETo x Kc, using Kc = 1.05 for bare soil and open water surfaces.
- Same as Column 6.
- Net precipitation (Column 12) falling on the catchment areas of LESF and UESP.
- Volume of accumulated inflows to storage equals sum of Columns 13 and 14.
- Outflow from storage (LESF and UESP) due to evaporation off the water surface; water surface is calculated based on volume in each of the LESF and UESP. Storage Evap = (LESF Surface Area + UESP Surface Area) x Net Evap.
- Percolation from LESF into ground based on an assumed hydraulic conductivity of 1x10-6 cm/sec or 0.003685 ft/day. LESF Perc. = 0.003685 x Days x LESF Surface Area = 0.003685 x Column 2 x Column 21
- Percolation from UESP into ground based on an assumed hydraulic conductivity of 1x10-6 cm/sec or 0.003685 ft/day. UESP Perc. = 0.003685 x Days x UESP Surface Area = 0.003685 x Column 2 x Column 21
- Annual frequency of 5.97 reach-exceed-water-level (ft) per year derived for La Contenta Golf Course and the addition of 100 acres of land that can be irrigated at 3.3 ft/yr (agronomic rate)
- Evaporation of recycled water from golf course Pond #7 based on pond surface area and net evaporation. Pond #7 Evaporation = Net Evaporation x 4.0 acres = Column 11 x 4.0 acres
- Percolation from Pond #7 into ground based on an assumed hydraulic conductivity of 1x10-6 cm/sec or 0.003685 ft/day. Pond #7 Perc. = 0.003685 x Days x Pond #7 Surface Area = 0.003685 x Column 2 x 4.0 acres
- Volume of accumulated outflows from storage sum of Columns 16 through 21.
- The required volume of storage is calculated by subtracting accumulated outflows from inflows; LESF is used to store Title 22 recycled water to a capacity of 172 ac-ft
- Polynomial equations are fit to graphical data (level v.s. capacity curve for LESF) and used to calculate level and surface area based on changes in the stored volume.
- Polynomial equations are fit to graphical data (level v.s. capacity curve for UESP) and used to calculate level and surface area based on changes in the stored volume.
- UESP is used as temporary or emergency storage if LESF is full; wastewater in UESP does not meet Title 22 and, therefore, it is pumped back to the headworks and returned to the treatment plant.
- Polynomial equations are fit to graphical data (level v.s. capacity curve for UESP) and used to calculate level and surface area based on changes in the stored volume.
- Polynomial equations are fit to graphical data (level v.s. capacity curve for UESP) and used to calculate level and surface area based on changes in the stored volume.
- For water balance, Total Storage = LESF storage + UESP storage = Column 23 + Column 26 = Accumulated Inflows - Accumulated Outflows = Column 15 - Column 22

Existing Customers
CCWD, 11/17/2016

APN	ADDRESS NO.	STREET	EDU	TYPE OF SERVICE
1 046016054	145	MANGILI RD		1.00 COM-OTHER
2 046016055	75	MANGILI RD (JITTERS)		1.00 C
3 046016066	351	HWY 26		1.00 C
4 046016081	10	NOVE WY		3.00 COM-REST
5 046036009	53	NOVE WY		1.00 C
6 046036011	13	MAIN ST		1.00 COM-REST
7 046036012	25	MAIN ST		1.00 C
8 046036017	127	MAIN ST		1.00 C
9 046036018	139	MAIN ST		1.00 COM
10 046036023	148	MAIN ST		1.00 COM-VL
11 046036026	94	MAIN ST		1.00 C
12 046036027	76	MAIN ST		1.00 COM-OTHER
13 046036028	42	MAIN ST		1.00 C
14 046036029	18	MAIN ST		1.00 C
15 046036044	65	MAIN ST		1.00 C
16 046036045	53	MAIN ST		1.00 C
17 046036047	4	JEAN ST - STE #3		1.00 C
18 046036047	4	JEAN ST - STE #1		1.00 C
19 046036047	4	JEAN ST - STE #2		1.00 COM
20 046036048	4	JEAN ST - STE #5		1.00 C
21 046036048	4	JEAN ST - STE #4		1.00 C
22 046036051	161	HWY 26		1.20 COMM
23 046036056	177	HWY 26 - CAR WASH		6.50 COM-CW
24 046036059	10	MAIN ST		1.00 C
25 046036060	105	MAIN ST		1.00 C
26 046036061	31	NOVE WY - VCT		1.00 COM-VL
27 046036062	7	NOVE WY		2.50 C
28 048056001	9136	CLIFF CT		1.00 R
29 048056002	9070	CLIFF CT		1.00 R
30 048056003	9054	CLIFF CT		1.00 R
31 048056004	9004	CLIFF CT		1.00 R
32 048056005	9003	CLIFF CT		1.00 R
33 048056006	9023	CLIFF CT		1.00 R
34 048056007	9051	CLIFF CT		1.00 R
35 048056008	9067	CLIFF CT		1.00 R
36 048057001	9060	SOUTHWORTH RD		1.00 R
37 048057002	8934	WESTWOOD CT		1.00 R
38 048057003	8844	WESTWOOD CT		1.00 R
39 048057004	8843	WESTWOOD CT		1.00 R
40 048057005	8933	WESTWOOD CT		1.00 R
41 048058001	7124	OSPITAL RD		1.00 R
42 048058002	7001	ELIZABETH CT		1.00 R
43 048058003	7017	ELIZABETH CT		1.00 R
44 048058004	7019	ELIZABETH CT		1.00 R
45 048058006	7153	ELIZABETH CT		1.00 R
46 048058007	7157	ELIZABETH CT		1.00 R
47 048058008	7160	ELIZABETH CT		1.00 R
48 048058009	7154	ELIZABETH CT		1.00 R
49 048058010	7020	ELIZABETH CT		1.00 R
50 048058011	7018	ELIZABETH CT		1.00 R
51 048058012	7016	ELIZABETH		1.00 R
52 048058013	7204	OSPITAL RD		1.00 R
53 048059001	7371	LESLIE CT		1.00 R
54 048059003	7247	OSPITAL RD		1.00 R
55 048059004	7407	STAGE STOP		1.00 R
56 048059007	7400	STAGE STOP		1.00 R
57 048059008	7409	STAGE STOP		1.00 R
58 048059009	7406	STAGE STOP		1.00 R
59 048059011	7414	OSPITAL		1.00 R
60 048060001	7542	OSPITAL		1.00 R
61 048060002	7571	PITT RANCH CT		1.00 R
62 048060003	7546	PITT RANCH CT		1.00 R
63 048060004	7555	PITT RANCH CT		1.00 R
64 048060005	7556	PITT RANCH CT		1.00 R
65 048060008	7646	OSPITAL RD		1.00 R
66 048060009	7564	PITT RANCH CT		1.00 R
67 048060010	7572	PITT RANCH		1.00 R
68 048073001	6567	OSPITAL RD		1.00 R
69 048073002	6671	OSPITAL RD		1.00 R
70 048073003	6733	OSPITAL RD		1.00 RES
71 048073004	6835	OSPITAL RD		1.00 R
72 048073005	6660	OSPITAL RD		1.00 R
73 048073006	9313	SOUTHWORTH RD		1.00 R
74 048074001	6921	OSPITAL RD		1.00 R

75	048074002	6963	OSPITAL RD	1.00 R
76	048074003	7005	OSPITAL RD	1.00 R
77	048074004	7047	OSPITAL RD	1.00 R
78	048074005	7081	OSPITAL RD	1.00 R
79	048075002	6800	OSPITAL RD	1.00 R
80	048075003	6880	OSPITAL RD	1.00 R
81	048075004	6930	OSPITAL RD	1.00 R
82	048075005	6980	OSPITAL RD.	1.00 R
83	048075006	7384	LESLIE CT	1.00 R
84	048076002	7501	LESLIE CT	1.00 R
85	048076003	7433	LESLIE CT	1.00 R
86	048076005	7474	OSPITAL	1.00 R
87	072010002	3521	ANTONOVICH RD	1.00 R
88	072010008	3484	PRISCILLA CT	1.00 R
89	072010009	3498	PRISCILLA CT	1.00 R
90	072010010	3500	PRISCILLA CT	1.00 R
91	072010011	3499	PRISCILLA CT	1.00 R
92	072010012	3481	PRISCILLA CT	1.00 R
93	072011001	3547	ANTONOVICH RD	1.00 R
94	072011002	3565	ANTONOVICH RD	1.00 R
95	072011004	3611	ANTONOVICH RD	1.00 R
96	072011005	3627	ANTONOVICH RD	1.00 R
97	072011006	3649	ANTONOVICH RD	1.00 R
98	072011023	3538	ANTONOVICH RD	1.00 R
99	072013006	3526	ANTONOVICH RD	1.00 R
100	073042090	1653	HWY 26	4.49 COM-OTHER
101	073042091	1653	HWY 26	1.00 C
102	073042091	0	ST ANDREWS/N PEBBL	1.90 C
103	073042091	795	LA CONTENTA DR	1.00 C
104	073042102	667	SPYGLASS RD	1.00 R
105	073042103	669	SPYGLASS RD	1.00 R
106	073042111	30	VISTA DEL LAGO WEST	1.00 C
107	073042114	10	VISTA DEL LAGO WEST	1.90 C
108	073042114	10	VISTA DEL LAGO WEST	1.00 C
109	073044001	1390	COUNTRY VIEW DR	1.00 C
110	073044012	1323	COUNTRY VIEW DR	1.00 COM-AR
111	073045001	2909	ROBIN RD	1.00 R
112	073045002	2917	ROBIN RD	1.00 R
113	073045003	2925	ROBIN RD	1.00 R
114	073045004	2908	ROBIN RD	1.00 R
115	073045005	2916	ROBIN RD	1.00 R
116	073045006	1052	MOCKINGBIRD HILL LN	1.00 R
117	073045007	1058	MOCKINGBIRD HILL LN	1.00 R
118	073045008	8	PELICAN PL	1.00 R
119	073045009	16	PELICAN PL	1.00 R
120	073045010	24	PELICAN PL	1.00 R
121	073045011	32	PELICAN PL	1.00 R
122	073045012	34	PELICAN PL	1.00 R
123	073045013	35	PELICAN PL	1.00 R
124	073045014	33	PELICAN PL	1.00 R
125	073045015	29	PELICAN PL	1.00 R
126	073045016	19	PELICAN PL	1.00 R
127	073045017	17	PELICAN PL	1.00 R
128	073045018	15	PELICAN PL	1.00 R
129	073045019	13	PELICAN PL	1.00 R
130	073045020	11	PELICAN PL	1.00 R
131	073045021	1072	MOCKINGBIRD HILL	1.00 R
132	073045022	1082	MOCKINGBIRD HILL LN	1.00 R
133	073045023	1094	MOCKINGBIRD HILL LN	1.00 R
134	073045024	1110	MOCKINGBIRD HILL LN	1.00 R
135	073045025	1114	MOCKINGBIRD HILL LN	1.00 R
136	073045026	1122	MOCKINGBIRD HILL LN	1.00 R
137	073045027	1125	MOCKINGBIRD HILL LN	1.00 R
138	073045028	1119	MOCKINGBIRD HILL LN	1.00 R
139	073045029	1107	MOCKINGBIRD HILL LN	1.00 R
140	073045030	1103	MOCKINGBIRD HILL LN	1.00 R
141	073045031	1097	MOCKINGBIRD HILL LN	1.00 R
142	073045032	1089	MOCKINGBIRD HILL LN	1.00 R
143	073045033	1085	MOCKINGBIRD HILL LN	1.00 R
144	073045034	1077	MOCKINGBIRD HILL LN	1.00 R
145	073045035	1069	MOCKINGBIRD HILL LN	1.00 R
146	073045036	1061	MOCKINGBIRD HILL LN	1.00 R
147	073045037	1053	MOCKINGBIRD HILL LN	1.00 R
148	073045038	1049	MOCKINGBIRD HILL LN	1.00 R
149	073045039	1045	MOCKINGBIRD HILL LN	1.00 R
150	073046001	20	PARAKEET CT	1.00 R
151	073046002	16	PARAKEET CT	1.00 R
152	073046003	8	PARAKEET CT	1.00 R

153	073046004	1020	MOCKINGBIRD HILL LN	1.00 R
154	073046005	1016	MOCKINGBIRD HILL LN	1.00 R
155	073046006	1009	MOCKINGBIRD HILL LN	1.00 R
156	073046007	1004	MOCKINGBIRD HILL LN	1.00 R
157	073046008	17	PARAKEET CT	1.00 R
158	073046009	1040	MOCKINGBIRD HILL LN	1.00 R
159	073046010	11	PARAKEET CT	1.00 R
160	073046011	1035	MOCKINGBIRD HILL LN	1.00 R
161	073046012	1033	MOCKINGBIRD HILL LN	1.00 R
162	073046013	1029	MOCKINGBIRD HILL LN	1.00 R
163	073046014	1021	MOCKINGBIRD HILL LN	1.00 R
164	073046015	1011	MOCKINGBIRD HILL LN	1.00 R
165	073046016	1005	MOCKINGBIRD HILL LN	1.00 R
166	073046018	16	WOODPECKER CT	1.00 R
167	073046019	24	WOODPECKER CT	1.00 R
168	073046020	32	WOODPECKER CT	1.00 R
169	073046021	1128	PARADISE PEAK RD	1.00 R
170	073046022	1124	PARADISE PEAK RD	1.00 R
171	073046030	1088	PARADISE PEAK RD	1.00 R
172	073046031	1084	PARADISE PEAK RD	1.00 R
173	073046032	1076	PARADISE PEAK RD	1.00 R
174	073046036	1011	PARADISE PEAK RD	12.00 MF
175	073046039	1085	PARADISE PEAK RD	1.00 R
176	073046040	1089	PARADISE PEAK RD	1.00 R
177	073046041	1091	PARADISE PEAK RD	1.00 R
178	073046043	1099	PARADISE PEAK RD	1.00 R
179	073046044	1103	PARADISE PEAK RD	1.00 R
180	073046045	1105	PARADISE PEAK RD	1.00 R
181	073046046	1111	PARADISE PEAK RD	1.00 R
182	073047002	313	VISTA DEL LAGO WEST	1.56 C
183	073048004	2271	LAKE VIEW CIR	1.00 R
184	073048005	2247	LAKE VIEW CIR	1.00 R
185	073048006	2221	LAKE VIEW CIR	1.00 R
186	073048007	2203	LAKE VIEW CIR	1.00 R
187	073048008	2202	LAKE VIEW CIR	1.00 R
188	073048009	2220	LAKE VIEW CIR	1.00 R
189	073048010	2246	LAKE VIEW CIR	1.00 R
190	073048011	2270	LAKE VIEW CT	1.00 R
191	073048014	2355	LAKE VIEW CIR	1.00 R
192	073048015	2299	LAKE VIEW CIR	1.00 R
193	073048016	2323	LAKE VIEW CIR	1.00 R
194	073051001	127	GOLD NUGGET DR	1.00 R
195	073051002	135	GOLD NUGGET DR	1.00 R
196	073051003	141	GOLD NUGGET DR	1.00 R
197	073051004	149	GOLD NUGGET DR	1.00 R
198	073051005	157	GOLD NUGGET DR	1.00 R
199	073051006	163	GOLD NUGGET DR	1.00 R
200	073051007	169	GOLD NUGGET DR	1.00 R
201	073051008	117	NORTH BRANCH CT	1.00 R
202	073051009	125	NORTH BRANCH CT	1.00 R
203	073051010	133	NORTH BRANCH CT	1.00 R
204	073051011	141	NORTH BRANCH CT	1.00 R
205	073051012	149	NORTH BRANCH CT	1.00 R
206	073051013	157	NORTH BRANCH CT	1.00 R
207	073051014	165	NORTH BRANCH CT	1.00 R
208	073051015	173	NORTH BRANCH CT	1.00 R
209	073051016	181	NORTH BRANCH CT	1.00 R
210	073051018	176	NORTH BRANCH CT	1.00 R
211	073051019	160	NORTH BRANCH CT	1.00 R
212	073051020	111	LAST CHANCE CT	1.00 R
213	073051021	115	LAST CHANCE CT	1.00 RES
214	073051022	127	LAST CHANCE CT	1.00 R
215	073051023	128	LAST CHANCE CT	1.00 R
216	073051024	122	LAST CHANCE RD	1.00 R
217	073051025	120	LAST CHANCE CT	1.00 R
218	073051026	185	GOLD NUGGET DR	1.00 R
219	073051027	191	GOLD NUGGET DR	1.00 R
220	073051028	199	GOLD NUGGET DR	1.00 R
221	073051029	205	GOLD NUGGET DR	1.00 R
222	073051030	103	GOLD KING DR	1.00 R
223	073051031	111	GOLD KING DR	1.00 R
224	073051032	119	GOLD KING DR	1.00 R
225	073051033	127	GOLD KING DR	1.00 R
226	073051034	135	GOLD KING DR	1.00 R
227	073051035	130	GOLD KING DR	1.00 RES
228	073051037	124	GOLD KING DR	1.00 RES
229	073051038	118	GOLD KING DR	1.00 RES
230	073051039	112	GOLD KING DR	1.00 RES

231	073051040	104	GOLD KING DR	1.00 RES
232	073051041	162	GOLD NUGGET DR	1.00 R
233	073051042	152	GOLD NUGGET DR	1.00 R
234	073051043	144	GOLD NUGGET DRIVE	1.00 R
235	073051044	138	GOLD NUGGET DRIVE	1.00 R
236	073051045	130	GOLD NUGGET DRIVE	1.00 R
237	073052001	104	GOLD DUST DR	1.00 R
238	073052002	200	GOLD CREEK DR	1.00 R
239	073052003	194	GOLD CREEK DR	1.00 R
240	073052004	186	GOLD CREEK DR	1.00 R
241	073052005	178	GOLD CREEK DR	1.00 R
242	073052006	172	GOLD CREEK DR	1.00 R
243	073052007	164	GOLD CREEK DR	1.00 R
244	073052008	156	GOLD CREEK DR	1.00 R
245	073052009	150	GOLD CREEK DR	1.00 R
246	073052010	107	GOLD NUGGET DR	1.00 R
247	073052011	115	GOLD NUGGET DR	1.00 R
248	073052012	121	GOLD NUGGET DR	1.00 R
249	073052013	116	GOLD NUGGET DR	1.25 COM-OTHER
250	073052019	175	GOLD CREEK DR	1.00 R
251	073052020	179	GOLD CREEK DR	1.00 R
252	073052021	189	GOLD CREEK DR	1.00 R
253	073052022	201	GOLD CREEK DR	1.00 R
254	073052023	209	GOLD CREEK DR	1.00 R
255	073052024	217	GOLD CREEK DR	1.00 R
256	073052025	206	GOLD KING DR	1.00 R
257	073052026	200	GOLD KING DR	1.00 R
258	073052027	105	HAPPY JACK CT	1.00 R
259	073052028	111	HAPPY JACK CT	1.00 R
260	073052029	121	HAPPY JACK CT	1.00 R
261	073052030	120	HAPPY JACK CT	1.00 R
262	073052031	112	HAPPY JACK CT	1.00 R
263	073052032	106	HAPPY JACK CT	1.00 R
264	073052033	162	GOLD KING DR	1.00 R
265	073052034	154	GOLD KING DR	1.00 R
266	073052035	146	GOLD KING DR	1.00 R
267	073052036	138	GOLD KING DR	1.00 R
268	073052038	143	GOLD KING DR	1.00 R
269	073052039	151	GOLD KING DR	1.00 R
270	073052040	159	GOLD KING DR	1.00 R
271	073052041	167	GOLD KING DR	1.00 R
272	073052042	175	GOLD KING DR	1.00 R
273	073052043	183	GOLD KING DR	1.00 R
274	073052044	191	GOLD KING DR	1.00 R
275	073052045	199	GOLD KING DR	1.00 R
276	073052046	207	GOLD KING DR	1.00 R
277	073053001	196	GOLD DUST CT	1.00 R
278	073053002	188	GOLD DUST CT	1.00 R
279	073053003	180	GOLD DUST CT	1.00 R
280	073053004	172	GOLD DUST DR	1.00 R
281	073053005	164	GOLD DUST DR	1.00 R
282	073053006	158	GOLD DUST DR	1.00 R
283	073053007	150	GOLD DUST DR	1.00 R
284	073053008	142	GOLD DUST DR	1.00 R
285	073053009	134	GOLD DUST DR	1.00 R
286	073053010	128	GOLD DUST DR	1.00 R
287	073053011	120	GOLD DUST DR	1.00 R
288	073053012	112	GOLD DUST DR	1.00 R
289	073053013	109	GOLD DUST DR	1.00 R
290	073053014	212	GOLD CREEK DR	1.00 R
291	073053015	127	GOLD DUST DR	1.00 R
292	073053016	135	GOLD DUST DR	1.00 R
293	073053017	141	GOLD DUST DR	1.00 R
294	073053018	147	GOLD DUST DR	1.00 R
295	073053019	153	GOLD DUST DR	1.00 R
296	073053020	159	GOLD DUST	1.00 R
297	073053021	280	GOLD KING DR	1.00 R
298	073053022	272	GOLD KING DR	1.00 R
299	073053023	260	GOLD KING DR	1.00 R
300	073053024	254	GOLD KING DR	1.00 R
301	073053025	246	GOLD KING DR	1.00 R
302	073053026	240	GOLD KING DR	1.00 R
303	073053027	236	GOLD KING DR	1.00 R
304	073053028	218	GOLD CREEK DR	1.00 R
305	073053029	224	GOLD KING DR	1.00 R
306	073053030	227	GOLD KING DR	1.00 R
307	073053031	233	GOLD KING DR	1.00 R
308	073053032	241	GOLD KING DR	1.00 R

309	073053033	249	GOLD KING DR	1.00 R
310	073053034	257	GOLD KING DR	1.00 R
311	073053035	263	GOLD KING DR	1.00 R
312	073053036	267	GOLD KING DR	1.00 R
313	073053037	271	GOLD KING DR	1.00 R
314	073053038	275	GOLD KING DR	1.00 R
315	073053039	279	GOLD KING DR	1.00 R
316	073053040	283	GOLD KING DR	1.00 R
317	073053041	289	GOLD KING DR	1.00 R
318	073053042	295	GOLD KING DR	1.00 R
319	073053043	179	GOLD DUST DR	1.00 R
320	073053044	187	GOLD DUST CT	1.00 R
321	073054001	275	GOLD CREEK DRIVE	1.00 R
322	073054002	281	GOLD CREEK DRIVE	1.00 R
323	073054003	287	GOLD CREEK DRIVE	1.00 R
324	073054004	293	GOLD CREEK DRIVE	1.00 R
325	073054005	299	GOLD CREEK DRIVE	1.00 R
326	073054006	305	GOLD CREEK DR	1.00 R
327	073054007	311	GOLD CREEK DRIVE	1.00 R
328	073054008	317	GOLD CREEK DRIVE	1.00 R
329	073054009	323	GOLD CREEK DR	1.00 R
330	073054010	329	GOLD CREEK DRIVE	1.00 R
331	073054011	335	GOLD CREEK DR	1.00 R
332	073054012	341	GOLD CREEK DR	1.00 R
333	073054013	347	GOLD CREEK DR	1.00 R
334	073054014	353	GOLD CREEK DR	1.00 R
335	073054015	107	BULLION HILL DR	1.00 R
336	073054016	113	BULLION HILL DR	1.00 R
337	073054017	119	BULLION HILL DRIVE	1.00 R
338	073054019	125	BULLION HILL DR	1.00 R
339	073054020	131	BULLION HILL DR	1.00 R
340	073054021	137	BULLION HILL DRIVE	1.00 R
341	073054022	143	BULLION HILL DR	1.00 R
342	073054023	149	BULLION HILL DR	1.00 R
343	073054024	155	BULLION HILL DR	1.00 R
344	073054025	154	BULLION HILL DRIVE	1.00 R
345	073054026	146	BULLION HILL DRIVE	1.00 R
346	073054027	138	BULLION HILL DRIVE	1.00 R
347	073054028	132	BULLION HILL DRIVE	1.00 R
348	073054029	116	BULLION HILL DRIVE	1.00 R
349	073054030	110	BULLION HILL DRIVE	1.00 R
350	073054031	104	BULLION HILL DRIVE	1.00 R
351	073054032	360	GOLD CREEK DR	1.00 R
352	073054033	354	GOLD CREEK DRIVE	1.00 R
353	073054034	103	GOLDEN LEAF CT	1.00 R
354	073054035	109	GOLDEN LEAF CT	1.00 R
355	073054036	114	LITTLE DIPPER CT	1.00 R
356	073054037	120	LITTLE DIPPER CT	1.00 R
357	073054039	111	LITTLE DIPPER CT	1.00 R
358	073054040	105	LITTLE DIPPER CT	1.00 RES
359	073054041	133	GOLDEN LEAF CT	1.00 R
360	073054042	139	GOLDEN LEAF CT	1.00 R
361	073054043	145	GOLDEN LEAF CT	1.00 R
362	073054044	151	GOLDEN LEAF CT	1.00 R
363	073054045	157	GOLDEN LEAF CT	1.00 R
364	073054046	161	GOLDEN LEAF CT	1.00 R
365	073054047	162	GOLDEN LEAF CT	1.00 RES
366	073054048	158	GOLDEN LEAF CT	1.00 RES
367	073054049	154	GOLDEN LEAF CT	1.00 R
368	073054050	148	GOLDEN LEAF CT	1.00 RES
369	073054051	142	GOLDEN LEAF CT	1.00 RES
370	073054052	136	GOLDEN LEAF CT	1.00 RES
371	073054053	130	GOLDEN LEAF CT	1.00 RES
372	073054054	324	GOLD CREEK DRIVE	1.00 R
373	073054055	316	GOLD CREEK DRIVE	1.00 R
374	073054056	308	GOLD CREEK DRIVE	1.00 R
375	073054057	302	GOLD CREEK DRIVE	1.00 R
376	073054058	296	GOLD CREEK DRIVE	1.00 R
377	073054059	290	GOLD CREEK DRIVE	1.00 R
378	073054060	286	GOLD CREEK DRIVE	1.00 R
379	073054061	280	GOLD CREEK DRIVE	1.00 R
380	073054062	274	GOLD CREEK DRIVE	1.00 R
381	073055003	208	BULLION HILL DRIVE	1.00 R
382	073055004	202	BULLION HILL DRIVE	1.00 R
383	073055005	196	BULLION HILL DRIVE	1.00 R
384	073055006	105	GOLDEN STAR DRIVE	1.00 R
385	073055007	174	BULLION HILL DRIVE	1.00 R
386	073055008	168	BULLION HILL DRIVE	1.00 R

387	073055009	162	BULLION HILL DRIVE	1.00 R
388	073055011	107	GOLD STANDARD CT	1.00 R
389	073055012	113	GOLD STANDARD CT	1.00 R
390	073055013	119	GOLD STANDARD CT	1.00 R
391	073055014	123	GOLD STANDARD CT	1.00 R
392	073055015	118	GOLD STANDARD CT	1.00 R
393	073055016	112	GOLD STANDARD CT	1.00 R
394	073055017	106	GOLD STANDARD CT	1.00 R
395	073055018	165	BULLION HILL DR	1.00 R
396	073055019	169	BULLION HILL DR	1.00 R
397	073055020	173	BULLION HILL DRIVE	1.00 R
398	073055021	179	BULLION HILL DR	1.00 R
399	073055022	185	BULLION HILL DRIVE	1.00 R
400	073055023	191	BULLION HILL DRIVE	1.00 R
401	073055024	197	BULLION HILL DR	1.00 R
402	073055025	203	BULLION HILL DRIVE	1.00 R
403	073057001	2400	LAKE VIEW CIR	1.00 R
404	073057002	2350	LAKE VIEW CIR	1.00 R
405	073057003	2302	LAKEVIEW DR	1.00 RES
406	073057004	2288	LAKEVIEW DR	1.00 RES
407	073058001	100	ROBINWOOD PL	1.00 RES
408	073058003	132	ROBINWOOD PL	1.00 RES
409	073058005	152	ROBINWOOD PL	1.00 R
410	073058006	164	ROBINWOOD PL	1.00 R
411	073058007	159	ROBINWOOD PL	1.00 RES
412	073058008	125	ROBINWOOD PL	1.00 R
413	073058010	362	WOODGATE RD	1.00 RES
414	073058012	373	WOODGATE RD	1.00 RES
415	073058013	351	WOODGATE	1.00 RES
416	073058014	319	WOODGATE RD	1.00 RES
417	073058015	293	WOODGATE RD	1.00 R
418	073059001	394	WOODGATE RD	1.00 RES
419	073059002	116	WARMWOOD PL	1.00 RES
420	073059003	130	WARMWOOD PL	1.00 RES
421	073059004	138	WARMWOOD PL	1.00 RES
422	073059006	157	WARMWOOD PL	1.00 R
423	073059014	521	WOODGATE RD	1.00 RES
424	073059015	503	WOODGATE RD	1.00 R
425	073059016	491	WOODGATE RD	1.00 RES
426	073059020	427	WOODGATE RD	1.00 RES
427	074-020-005	740	LA CONTENTA DR	1.00 R
428	074001001	1919	VISTA DEL LAGO (#7)	2.00 COM-INST
429	074001001	1919	VISTA DEL LAGO (#9B)	1.54 C
430	074001001	1919	VISTA DEL LAGO (#10)	1.00 C
431	074001001	1919	VISTA DEL LAGO (#1)	1.00 COM-OTHER
432	074001001	1919	VISTA DEL LAGO (#3)	1.00 C
433	074001001	1919	VISTA DEL LAGO (#2)	1.00 COM-RE
434	074001001	1919	VISTA DEL LAGO (#4)	1.00 COM-OTHER
435	074001001	1919	VISTA DEL LAGO (#9A)	1.00 COM-MO
436	074001001	1919	VISTA DEL LAGO (#5)	1.47 C
437	074001001	1919	VISTA DEL LAGO (#6)	1.00 COM-RS
438	074001001	1919	VISTA DEL LAGO (#11)	2.40 COM-DENT
439	074001009	1962	VISTA DEL LAGO DR	1.00 R
440	074001010	1957	VISTA DEL LAGO DR	1.00 R
441	074001011	2029	GREENBRIAR RD	1.00 R
442	074001012	2037	GREENBRIAR RD	1.00 R
443	074001013	2049	GREENBRIAR RD	1.00 R
444	074001015	2060	GREENBRIAR RD	1.00 R
445	074001016	2034	GREENBRIAR RD	1.00 R
446	074001019	1906	VISTA DEL LAGO DR	8.46 COM-MM
447	074001020	1900	VISTA DEL LAGO DR	2.00 COM-MM
448	074002006	2083	HWY 26	1.00 R
449	074002007	2101	HWY 26	1.00 R
450	074002008	2166	PARTRIDGE DR	1.00 R
451	074002012	2062	HARTVICKSON LN	1.00 R
452	074002013	2046	HARTVICKSON LN	1.00 R
453	074002015	2010	HARTVICKSON LN	1.00 COM-DC
454	074002016	2085	HARTVICKSON LN	1.00 R
455	074002017	2067	HARTVICKSON LN	1.00 R
456	074002018	2049	HARTVICKSON LN	1.00 R
457	074002019	2031	HARTVICKSON LN	1.00 R
458	074002020	2016	GROUSE DR	1.00 R
459	074002021	2078	WREN CT	1.00 R
460	074002022	2096	WREN CT	1.00 R
461	074002024	2097	WREN CT	1.00 R
462	074002025	2079	WREN CT	1.00 R
463	074002026	2083	GROUSE DR	1.00 R
464	074002027	2065	GROUSE DR	1.00 R

465 074002028	2047	GROUSE DR	1.00 R
466 074002029	2029	GROUSE DR	1.00 R
467 074002030	2011	GROUSE DR	1.00 R
468 074002031	2008	VISTA DEL LAGO DR	1.00 R
469 074002032	2036	VISTA DEL LAGO DR	1.00 R
470 074002033	2101	GROUSE DR	1.00 R
471 074002034	2078	HARTVICKSON LN	1.00 R
472 074002035	2130	PARTRIDGE DR	1.00 R
473 074002037	2045	HWY 26	1.00 R
474 074002038	2025	HWY 26	1.00 R
475 074002041	2065	HWY 26	1.00 R
476 074003001	2111	HARTVICKSON LN	1.00 R
477 074003002	2127	HARTVICKSON LN	1.00 R
478 074003003	2153	HARTVICKSON LN	1.00 R
479 074003004	2333	PARTRIDGE CT	1.00 R
480 074003005	2341	PARTRIDGE CT	1.00 R
481 074003007	2342	PARTRIDGE CT	1.00 R
482 074003008	2209	HARTVICKSON LN	1.00 R
483 074003009	2300	PARTRIDGE DR	1.00 R
484 074003010	2288	PARTRIDGE DR	1.00 R
485 074003011	2274	PARTRIDGE DR	1.00 R
486 074003012	2258	PARTRIDGE DR	1.00 R
487 074003014	2226	PARTRIDGE DR	1.00 R
488 074003015	2210	PARTRIDGE DR	1.00 R
489 074003017	2178	PARTRIDGE DR	1.00 R
490 074003018	2115	HWY 26	1.00 R
491 074003019	2133	HWY 26	1.00 R
492 074003020	2151	HWY 26	1.00 R
493 074003021	2169	HWY 26	1.00 R
494 074003022	2187	HWY 26	1.00 R
495 074003024	2295	PARTRIDGE DR	1.00 R
496 074003025	2281	PARTRIDGE DR	1.00 R
497 074003026	2249	PARTRIDGE DR	1.00 R
498 074003028	2153	PARTRIDGE DR	1.00 R
499 074003029	2129	PARTRIDGE DR	1.00 R
500 074004001	2115	GROUSE DR	1.00 R
501 074004002	2108	QUAIL CT	1.00 R
502 074004003	2092	QUAIL CT	1.00 R
503 074004004	2084	QUAIL CT	1.00 R
504 074004005	2287	GROUSE DR	1.00 R
505 074004006	2275	GROUSE DR	1.00 R
506 074004007	2245	GROUSE DR	1.00 R
507 074004008	2209	GROUSE DR	1.00 R
508 074004009	2177	GROUSE DR	1.00 R
509 074004011	2099	QUAIL CT	1.00 R
510 074004012	2085	QUAIL CT	1.00 R
511 074004017	2157	QUAIL CT	1.00 R
512 074004019	2166	GROUSE DR	1.00 R
513 074004020	2182	GROUSE DR	1.00 R
514 074004021	2196	GROUSE DR	1.00 R
515 074004023	2226	GROUSE DR	1.00 R
516 074004024	2240	GROUSE DR	1.00 R
517 074004025	2254	GROUSE DR	1.00 R
518 074004026	2268	GROUSE DR	1.00 R
519 074004027	2278	GROUSE DR	1.00 R
520 074004028	2288	GROUSE DR	1.00 R
521 074004029	2158	QUAIL CT	1.00 R
522 074004030	2168	QUAIL CT	1.00 R
523 074005001	2088	GREENBRIAR RD	1.00 R
524 074005002	2077	GREENBRIAR RD	1.00 R
525 074005003	2089	GREENBRIAR RD	1.00 R
526 074005004	2103	GREENBRIAR RD	1.00 R
527 074005006	2044	VISTA DEL LAGO	1.00 R
528 074005007	2062	VISTA DEL LAGO DR	1.00 R
529 074005008	2076	VISTA DEL LAGO DR	1.00 R
530 074005009	2090	VISTA DEL LAGO DR	1.00 R
531 074005010	2323	GROUSE DR	1.00 R
532 074005011	2322	GROUSE DR	1.00 R
533 074005012	2162	VISTA DEL LAGO DR	1.00 R
534 074005013	2202	VISTA DEL LAGO DR	1.00 R
535 074005014	2222	VISTA DEL LAGO DR	1.00 R
536 074005015	2244	VISTA DEL LAGO DR	1.00 R
537 074005016	2304	HUCKLEBERRY LN	1.00 R
538 074005017	2334	HUCKLEBERRY LN	1.00 R
539 074005018	2361	TOYON CT	1.00 R
540 074005019	2345	TOYON CT	1.00 R
541 074005020	2337	TOYON CT	1.00 R
542 074006001	2303	HUCKLEBERRY LN	1.00 R

543	074006002	2310	VISTA DEL LAGO DR	1.00 R
544	074006003	2326	VISTA DEL LAGO DR	1.00 R
545	074006005	2385	MEADOWOOD DR	1.00 R
546	074006006	2331	HUCKLEBERRY LN	1.00 R
547	074006007	2369	TOYON CT	1.00 R
548	074006008	2368	TOYON CT	1.00 R
549	074006009	2352	TOYON CT	1.00 R
550	074006010	2340	TOYON CT	1.00 R
551	074006011	2426	HUCKLEBERRY LN	1.00 R
552	074006012	2442	HUCKLEBERRY LN	1.00 R
553	074006013	2458	HUCKLEBERRY LN	1.00 R
554	074006015	2476	HUCKLEBERRY LN	1.00 R
555	074006016	2492	HUCKLEBERRY LN	1.00 R
556	074006019	2499	HUCKLEBERRY LN	1.00 R
557	074006020	2481	HUCKLEBERRY LN	1.00 R
558	074006021	2463	HUCKLEBERRY LN	1.00 R
559	074006022	2441	HUCKLEBERRY LN	1.00 R
560	074006023	2421	HUCKLEBERRY LN	1.00 R
561	074006024	2393	HUCKLEBERRY LN	1.00 R
562	074006025	2375	HUCKLEBERRY LN	1.00 R
563	074006026	2364	MEADOWOOD DR	1.00 R
564	074006027	2380	MEADOWOOD DR	1.00 R
565	074006028	2400	MEADOWOOD DR	1.00 R
566	074006030	2439	HUB CT	1.00 R
567	074006031	2442	HUB CT	1.00 R
568	074006032	2493	HOGAN CT	1.00 R
569	074006033	2494	HOGAN CT	1.00 R
570	074006034	2502	HOGAN CT	1.00 R
571	074006035	2514	HOGAN CT	1.00 R
572	074006036	2530	HOGAN CT	1.00 R
573	074006037	2544	HOGAN CT	1.00 R
574	074006038	2547	BLACKBART DR	1.00 R
575	074006039	2523	HOGAN CT	1.00 R
576	074006040	2503	HOGAN CT	1.00 R
577	074007001	2450	MEADOWOOD DR	1.00 R
578	074007002	2472	MEADOWOOD DR	1.00 R
579	074007003	2494	MEADOWOOD DR	1.00 R
580	074007004	2693	BLACK BART DR	1.00 R
581	074007005	2679	BLACK BART DR	1.00 R
582	074007006	2661	BLACK BART DR	1.00 R
583	074007007	2643	BLACK BART DR	1.00 R
584	074007008	2615	BLACK BART DR	1.00 R
585	074007009	2581	BLACK BART DR	1.00 R
586	074007010	2539	HUCKLEBERRY LN	1.00 R
587	074007011	2524	BLACK BART DR	1.00 R
588	074007012	2544	BLACK BART DR	1.00 R
589	074007013	2566	BLACK BART DR	1.00 R
590	074007014	2582	BLACK BART DR	1.00 R
591	074007015	2600	BLACK BART DR	1.00 R
592	074007016	2620	BLACK BART DR	1.00 R
593	074007017	2638	BLACK BART DR	1.00 R
594	074007018	2656	BLACK BART DR	1.00 R
595	074007019	2676	BLACK BART DR	1.00 R
596	074007020	2694	BLACK BART DR	1.00 R
597	074007021	2712	BLACK BART DR	1.00 R
598	074007022	2726	BLACK BART DR	1.00 R
599	074007024	2574	MEADOWOOD DR	1.00 R
600	074007025	2589	GOLD RUN CT	1.00 R
601	074007026	2569	GOLD RUN CT	1.00 R
602	074007027	2553	GOLD RUN CT	1.00 R
603	074007030	2515	GOLD RUN CT	1.00 R
604	074007031	2514	GOLD RUN CT	1.00 R
605	074007032	2522	GOLD RUN CT	1.00 R
606	074007033	2536	GOLD RUN CT	1.00 R
607	074007034	2556	GOLD RUN CT	1.00 R
608	074008002	2548	HUCKLEBERRY LN	1.00 R
609	074008004	2584	HUCKLEBERRY LN	1.00 R
610	074008005	2600	HUCKLEBERRY LN	1.00 R
611	074008006	2612	HUCKLEBERRY LN	1.00 R
612	074008008	2668	MALLARD CT	1.00 R
613	074008010	2653	MALLARD CT	1.00 R
614	074008011	2646	HUCKLEBERRY LN	1.00 R
615	074008012	2676	HUCKLEBERRY LN	1.00 R
616	074008013	2706	HUCKLEBERRY LN	1.00 R
617	074008014	2709	HUCKLEBERRY LN	1.00 R
618	074008015	2695	HUCKLEBERRY LN	1.00 R
619	074008016	2677	HUCKLEBERRY LN	1.00 R
620	074008017	2655	HUCKLEBERRY LN	1.00 R

621	074008018	2629	HUCKLEBERRY LN	1.00 R
622	074008019	2597	HUCKLEBERRY LN	1.00 R
623	074008020	2616	STAGE COACH DR	1.00 R
624	074008021	2640	STAGE COACH DR	1.00 R
625	074008022	2668	STAGE COACH DR	1.00 R
626	074008023	2686	STAGE COACH DR	1.00 R
627	074008024	2704	STAGE COACH DR	1.00 R
628	074008025	2750	TEAL CT	1.00 R
629	074008027	2757	TEAL CT	1.00 R
630	074008029	2768	STAGE COACH DR	1.00 R
631	074008030	2570	GOLD RUN CT	1.00 R
632	074008031	2618	MEADOWOOD DR	1.00 R
633	074008032	2787	STAGE COACH DR	1.00 R
634	074008033	2767	STAGE COACH DR	1.00 R
635	074008034	2747	STAGE COACH DR	1.00 R
636	074008037	2695	STAGE COACH DR	1.00 R
637	074008038	2679	STAGE COACH DR	1.00 R
638	074008039	2661	STAGE COACH DR	1.00 R
639	074008040	2645	STAGE COACH DR	1.00 R
640	074008042	2613	STAGE COACH DR	1.00 R
641	074008043	2593	STAGE COACH DR	1.00 R
642	074009001	2593	MEADOWOOD DR	1.00 R
643	074009002	2612	SILVERADO DR	1.00 R
644	074009003	2630	SILVERADO DR	1.00 R
645	074009004	2644	SILVERADO DR	1.00 R
646	074009005	2662	SILVERADO DR	1.00 R
647	074009006	2682	SILVERADO DR	1.00 R
648	074009007	2700	SILVERADO DR	1.00 R
649	074009008	2718	SILVERADO DR	1.00 R
650	074009009	2736	SILVERADO DR	1.00 R
651	074009010	2760	SILVERADO DR	1.00 R
652	074009011	2778	SILVERADO DR	1.00 R
653	074009012	3011	STAGE COACH DR	1.00 R
654	074009013	2993	STAGE COACH DR	1.00 R
655	074009015	2967	STAGE COACH DR	1.00 R
656	074009016	2947	STAGE COACH DR	1.00 R
657	074009017	2931	STAGE COACH DR	1.00 R
658	074009019	2893	STAGE COACH DR	1.00 R
659	074009020	2871	STAGE COACH DR	1.00 R
660	074009021	2853	STAGE COACH DR	1.00 R
661	074009022	2833	STAGE COACH DR	1.00 R
662	074009024	2856	OAK CT	1.00 R
663	074009025	2872	OAK CT	1.00 R
664	074009027	2857	STAGE COACH DR	1.00 R
665	074009028	2880	STAGE COACH DR	1.00 R
666	074009030	2914	STAGE COACH DR	1.00 R
667	074009031	2932	STAGE COACH DR	1.00 R
668	074009032	2984	CEDAR CT	1.00 R
669	074009034	2997	CEDAR CT	1.00 R
670	074009035	2985	CEDAR CT	1.00 R
671	074009036	2992	STAGE COACH DR	1.00 R
672	074009037	3010	STAGE COACH DR	1.00 R
673	074010001	2478	VISTA DEL LAGO DR	1.00 R
674	074010003	2518	VISTA DEL LAGO DR	1.00 R
675	074010005	2560	VISTA DEL LAGO DR	1.00 R
676	074010006	2584	VISTA DEL LAGO DR	1.00 R
677	074010007	2610	VISTA DEL LAGO DR	1.00 R
678	074010008	2761	SILVERADO DR	1.00 R
679	074010009	2737	SILVERADO DR	1.00 R
680	074010010	2723	SILVERADO DR	1.00 R
681	074010011	2705	SILVERADO DR	1.00 R
682	074010012	2661	GLEN CT	1.00 R
683	074010013	2649	GLEN CT	1.00 R
684	074010014	2633	GLEN CT	1.00 R
685	074010018	2559	CREST CT	1.00 R
686	074010021	2551	MEADOWOOD DR	1.00 R
687	074010022	2561	MEADOWOOD DR	1.00 R
688	074010023	2613	SILVERADO DR	1.00 R
689	074010024	2637	SILVERADO DR	1.00 R
690	074010025	2660	SILVERADO DR	1.00 R
691	074010026	2648	GLEN CT	1.00 R
692	074011001	2359	VISTA DEL LAGO DR	1.00 R
693	074011002	2375	VISTA DEL LAGO DR	1.00 R
694	074011003	2391	VISTA DEL LAGO DR	1.00 R
695	074011004	2407	VISTA DEL LAGO DR	1.00 R
696	074011005	2423	VISTA DEL LAGO DR	1.00 R
697	074011006	2441	VISTA DEL LAGO DR	1.00 R
698	074011007	2457	VISTA DEL LAGO DR	1.00 R

699 074011009	2489	VISTA DEL LAGO DR	1.00 R
700 074011010	2505	VISTA DEL LAGO DR	1.00 R
701 074011011	2521	VISTA DEL LAGO DR	1.00 R
702 074011013	2549	VISTA DEL LAGO DR	1.00 R
703 074011014	2457	SNAG CT	1.00 R
704 074011015	2475	SNAG CT	1.00 R
705 074011016	2486	SNAG CT	1.00 R
706 074011017	2476	SNAG CT	1.00 R
707 074011018	2458	SNAG CT	1.00 R
708 074011019	2398	VISTA DEL LAGO DR	1.00 R
709 074011020	2378	VISTA DEL LAGO DR	1.00 R
710 074011021	2362	VISTA DEL LAGO DR	1.00 R
711 074011022	2346	VISTA DEL LAGO DR	1.00 R
712 074011023	2425	MEADOWOOD DR	1.00 R
713 074011024	2445	MEADOWOOD DR	1.00 R
714 074011025	2461	MEADOWOOD DR	1.00 R
715 074011026	2471	MEADOWOOD DR	1.00 R
716 074011027	2495	MEADOWOOD DR	1.00 R
717 074011028	2473	VISTA DEL LAGO DR	1.00 R
718 074012001	2841	VISTA DEL LAGO DR	1.00 R
719 074012002	2751	VISTA DEL LAGO DR	1.00 R
720 074012003	2723	VISTA DEL LAGO DR	1.00 R
721 074012006	2648	SHADOW LN	1.00 R
722 074012007	2625	VISTA DEL LAGO DR	1.00 R
723 074012009	2587	VISTA DEL LAGO DR	1.00 R
724 074012010	2695	VISTA DEL LAGO DR	1.00 R
725 074012011	2647	SHADOW LN	1.00 R
726 074013002	2816	VISTA DEL LAGO DR	1.00 R
727 074013003	2800	VISTA DEL LAGO DR	1.00 R
728 074013004	2774	VISTA DEL LAGO DR	1.00 R
729 074013005	2742	VISTA DEL LAGO DR	1.00 R
730 074013006	2718	VISTA DEL LAGO DR	1.00 R
731 074013007	2702	VISTA DEL LAGO DR	1.00 R
732 074013008	2686	VISTA DEL LAGO DR	1.00 R
733 074013010	2678	SHADOW LN	1.00 R
734 074013011	2698	SHADOW LN	1.00 R
735 074013012	2796	SILVERADO DR	1.00 R
736 074013013	3031	STAGE COACH CT	1.00 R
737 074013015	2709	SHADOW LN	1.00 R
738 074013016	3083	STAGE COACH CT	1.00 R
739 074013017	3099	STAGE COACH CT	1.00 R
740 074013018	3117	STAGE COACH CT	1.00 R
741 074013019	3135	STAGE COACH CT	1.00 R
742 074013020	3147	STAGE COACH CT	1.00 R
743 074013021	3151	STAGE COACH CT	1.00 R
744 074013023	2944	CASCADE LN	1.00 R
745 074013026	2939	CASCADE LN	1.00 R
746 074013027	2951	CASCADE LN	1.00 R
747 074013029	3136	STAGE COACH CT	1.00 R
748 074013030	3116	STAGE COACH CT	1.00 R
749 074013031	3100	STAGE COACH CT	1.00 R
750 074013032	3082	STAGE COACH CT	1.00 R
751 074013033	2767	SHADOW LN	1.00 R
752 074013035	2770	SHADOW LN	1.00 R
753 074013036	2786	SHADOW LN	1.00 R
754 074015001	185	ST ANDREWS RD	1.00 R
755 074015002	167	ST ANDREWS RD	1.00 R
756 074015003	151	ST ANDREWS RD	1.00 R
757 074015006	101	ST ANDREWS RD	1.00 R
758 074015007	85	ST ANDREWS RD	1.00 R
759 074015008	67	ST ANDREWS RD	1.00 R
760 074015009	43	ST ANDREWS RD	1.00 R
761 074015011	15	ST ANDREWS RD	3.00 COM-OTHER
762 074015017	84	ST ANDREWS RD	1.00 R
763 074015020	134	ST ANDREWS RD	1.00 R
764 074015021	150	ST ANDREWS RD	1.00 R
765 074015022	166	ST ANDREWS RD	1.00 R
766 074015023	186	ST ANDREWS RD	1.00 R
767 074015024	316	LA CONTENTA DR	1.00 R
768 074015025	346	LA CONTENTA DR	1.00 R
769 074015026	362	LA CONTENTA DR	1.00 R
770 074015027	378	LA CONTENTA DR	1.00 R
771 074015028	394	LA CONTENTA DR	1.00 R
772 074015029	410	LA CONTENTA DR	1.00 R
773 074015037	14	ST ANDREWS RD	2.25 C
774 074015039	36	ST ANDREWS RD	1.00 R
775 074015040	50	ST ANDREWS RD	1.00 R
776 074015041	66	ST ANDREWS RD	1.00 R

777 074015042	117	ST ANDREWS RD	1.00 R
778 074015043	135	ST ANDREWS RD	1.00 R
779 074016001	201	ST ANDREWS RD	1.00 R
780 074016002	217	ST ANDREWS RD	1.00 R
781 074016003	229	ST ANDREWS RD	1.00 R
782 074016004	236	OAKMONT CT	1.00 R
783 074016005	216	OAKMONT CT	1.00 R
784 074016006	198	OAKMONT CT	1.00 R
785 074016007	184	OAKMONT CT	1.00 R
786 074016008	180	OAKMONT CT	1.00 R
787 074016009	185	OAKMONT CT	1.00 R
788 074016010	203	OAKMONT CT	1.00 R
789 074016012	295	ST ANDREWS RD	1.00 R
790 074016013	317	ST ANDREWS RD	1.00 R
791 074016015	299	AUGUSTA CT	1.00 R
792 074016017	323	AUGUSTA CT	1.00 R
793 074016019	335	AUGUSTA CT	1.00 R
794 074016020	336	AUGUSTA CT	1.00 R
795 074016021	324	AUGUSTA CT	1.00 R
796 074016022	274	ST ANDREWS RD	1.00 R
797 074016023	260	ST ANDREWS RD	1.00 R
798 074016024	238	ST ANDREWS RD	1.00 R
799 074017001	408	LA CONTENTA WY	1.00 R
800 074017002	381	LA CONTENTA DR	1.00 R
801 074017003	399	LA CONTENTA DR	1.00 R
802 074017004	425	LA CONTENTA DR	1.00 R
803 074017005	465	LA CONTENTA DR	1.00 R
804 074017006	493	LA CONTENTA DR	1.00 R
805 074017007	440	LA CONTENTA DR	1.00 R
806 074017008	538	LA CONTENTA DR	1.00 R
807 074017009	520	LA CONTENTA DR	1.00 R
808 074017010	506	LA CONTENTA DR	1.00 R
809 074017011	490	LA CONTENTA DR	1.00 R
810 074017012	476	LA CONTENTA DR	1.00 R
811 074017014	450	LA CONTENTA DR	1.00 R
812 074017016	371	LA CONTENTA WY	1.00 R
813 074017018	405	LA CONTENTA WY	1.00 R
814 074017020	445	LA CONTENTA WY	1.00 R
815 074017021	543	LA CONTENTA DR	1.00 R
816 074017022	438	LA CONTENTA DR	1.00 R
817 074017023	424	LA CONTENTA DR	1.00 R
818 074018001	561	LA CONTENTA DR	1.00 R
819 074018003	615	OLD COURSE CT	1.00 R
820 074018005	643	OLD COURSE CT	1.00 R
821 074018008	630	OLD COURSE CT	1.00 R
822 074018009	614	OLD COURSE CT	1.00 R
823 074018010	629	LA CONTENTA DR	1.00 R
824 074018011	643	LA CONTENTA DR	1.00 R
825 074018012	648	ST ANDREWS RD	1.00 R
826 074018013	628	ST ANDREWS RD	1.00 R
827 074018014	612	ST ANDREWS RD	1.00 R
828 074018015	596	ST ANDREWS RD	1.00 R
829 074018016	580	ST ANDREWS RD	1.00 R
830 074018018	548	ST ANDREWS RD	1.00 R
831 074018019	528	ST ANDREWS RD	1.00 R
832 074018020	510	ST ANDREWS RD	1.00 R
833 074018024	421	S PEBBLE BEACH CT	1.00 R
834 074018026	441	S PEBBLE BEACH CT	1.00 R
835 074018028	418	S PEBBLE BEACH CT	1.00 R
836 074018032	381	N PEBBLE BEACH CT	1.00 R
837 074018033	397	N PEBBLE BEACH CT	1.00 R
838 074018034	415	N PEBBLE BEACH CT	1.00 R
839 074018035	437	N PEBBLE BEACH CT	1.00 R
840 074018036	499	ST ANDREWS RD	1.00 R
841 074018037	515	ST ANDREWS RD	1.00 R
842 074018038	531	ST ANDREWS RD	1.00 R
843 074018039	547	ST ANDREWS RD	1.00 R
844 074019001	556	LA CONTENTA DR	1.00 R
845 074019003	596	LA CONTENTA DR	1.00 R
846 074019005	636	LA CONTENTA DR	1.00 R
847 074019006	724	ST ANDREWS DR	1.00 R
848 074019007	746	ST ANDREWS DR	1.00 R
849 074019008	762	ST ANDREWS DR	1.00 R
850 074019009	778	ST ANDREWS DR	1.00 R
851 074019010	794	ST ANDREWS DR	1.00 R
852 074019011	808	ST ANDREWS DR	1.00 R
853 074019012	820	ST ANDREWS DR	1.00 R
854 074019013	832	ST ANDREWS DR	1.00 R

855 074019016	868	ST ANDREWS DR	1.00 R
856 074019017	880	ST ANDREWS DR	1.00 R
857 074019019	890	ST ANDREWS DR	1.00 R
858 074019020	900	ST ANDREWS DR	1.00 R
859 074019021	910	ST ANDREWS DR	1.00 R
860 074019027	670	LA CONTENTA DR	1.00 R
861 074019028	686	LA CONTENTA DR	1.00 R
862 074019029	700	LA CONTENTA DR	1.00 R
863 074020001	926	ST ANDREWS DR	1.00 R
864 074020002	942	ST ANDREWS DR	1.00 R
865 074020003	960	ST ANDREWS DR	1.00 R
866 074020004	720	LA CONTENTA DR	1.00 R
867 074020006	717	LA CONTENTA DR	1.00 R
868 074020007	693	LA CONTENTA DR	1.00 R
869 074020008	689	ST ANDREWS RD	1.00 R
870 074020009	671	ST ANDREWS RD	1.00 R
871 074020010	643	ST ANDREWS DR	1.00 R
872 074020011	703	BLUE HERON CT	1.00 R
873 074020012	721	BLUE HERON CT	1.00 R
874 074020013	741	BLUE HERRON CT	1.00 R
875 074021001	627	ST ANDREWS RD	1.00 R
876 074021002	611	ST ANDREWS RD	1.00 R
877 074021003	595	ST ANDREWS RD	1.00 R
878 074021004	579	ST ANDREWS RD	1.00 R
879 074021005	563	ST ANDREWS RD	1.00 R
880 074021007	572	BLUE HERON CT	1.00 R
881 074021008	556	BLUE HERON CT	1.00 R
882 074021009	542	BLUE HERON CT	1.00 R
883 074021010	536	BLUE HERON CT	1.00 R
884 074021011	537	BLUE HERON CT	1.00 R
885 074021012	563	BLUE HERON CT	1.00 R
886 074021013	581	BLUE HERON CT	1.00 R
887 074021014	597	BLUE HERON CT	1.00 R
888 074021015	611	BLUE HERON CT	1.00 R
889 074021016	629	BLUE HERON CT	1.00 R
890 074021017	649	BLUE HERON CT	1.00 R
891 074021018	667	BLUE HERON CT	1.00 R
892 074021019	685	BLUE HERON CT	1.00 R
893 074022003	840	LA CONTENTA DR	1.00 R
894 074022004	856	LA CONTENTA DR	1.00 R
895 074022005	855	LA CONTENTA DR	1.00 R
896 074022006	2253	VISTA DEL LAGO DR	1.00 R
897 074022007	2267	VISTA DEL LAGO DR	1.00 R
898 074022008	2285	VISTA DEL LAGO DR	1.00 R
899 074022011	505	SILVER RD	1.00 R
900 074022012	493	SILVER RD	1.00 R
901 074022013	475	SILVER RD	1.00 R
902 074023001	525	SILVER RD	1.00 R
903 074023002	531	SILVER RD	1.00 R
904 074023003	526	PINE VALLEY CT	1.00 R
905 074023004	506	PINE VALLEY CT	1.00 R
906 074023005	488	PINE VALLEY CT	1.00 R
907 074023006	470	PINE VALLEY CT	1.00 R
908 074023007	464	PINE VALLEY CT	1.00 R
909 074023009	473	PINE VALLEY CT	1.00 R
910 074023010	501	PINE VALLEY CT	1.00 R
911 074023011	525	PINE VALLEY CT	1.00 R
912 074023012	618	PEACHTREE CT	1.00 R
913 074023013	602	PEACHTREE CT	1.00 R
914 074023015	586	PEACHTREE CT	1.00 R
915 074023017	601	PEACHTREE CT	1.00 R
916 074023018	619	PEACHTREE CT	1.00 R
917 074024001	597	SILVER RD	1.00 R
918 074024002	623	SILVER RD	1.00 R
919 074024003	643	SILVER RD	1.00 R
920 074024004	652	PEACHTREE CT	1.00 R
921 074024005	634	PEACHTREE CT	1.00 R
922 074024006	641	PEACHTREE CT	1.00 R
923 074024007	679	SILVER RD	1.00 R
924 074024008	700	SPYGLASS RD	1.00 R
925 074024009	760	SILVER RD	1.00 R
926 074024010	721	SPYGLASS CT	1.00 R
927 074024012	747	SPYGLASS CT	1.00 R
928 074024013	750	SPYGLASS CT	1.00 R
929 074024014	734	SPYGLASS CT	1.00 R
930 074024017	618	SILVER RD	1.00 R
931 074024018	602	SILVER RD	1.00 R
932 074024019	588	SILVER RD	1.00 R

933 074024020	572	SILVER RD	1.00 R
934 074024021	550	SILVER RD	1.00 R
935 074024022	538	SILVER RD	1.00 R
936 074024023	528	SILVER RD	1.00 R
937 074024024	502	SILVER RD	1.00 R
938 074024025	478	SILVER RD	1.00 R
939 074024026	636	SILVER RD	1.00 R
940 074025001	679	SPYGLASS RD	1.00 R
941 074025002	731	SILVER RD	1.00 R
942 074025003	777	LODE CT	1.00 R
943 074025004	795	LODE CT	1.00 R
944 074025006	792	LODE CT	1.00 R
945 074025007	802	LODE CT	1.00 R
946 074025009	2644	SHADOW LN	1.00 R
947 074025010	2643	SHADOW LN	1.00 R
948 074025012	622	STANFORD CT	1.00 R
949 074025013	630	STANFORD CT	1.00 R
950 074025014	623	STANFORD CT	1.00 R
951 074025015	615	STANFORD CT	1.00 R
952 074025016	603	STANFORD CT	1.00 R
953 074025017	561	OAK RIDGE RD	1.00 R
954 074025018	574	BROOKLINE CT	1.00 R
955 074025019	584	BROOKLINE CT	1.00 R
956 074025020	587	BROOKLINE CT	1.00 R
957 074025022	575	BROOKLINE CT	1.00 R
958 074025023	908	CARSON DR	1.00 R
959 074025024	892	CARSON DRIVE	1.00 R
960 074025025	880	CARSON DR	1.00 R
961 074025026	870	CARSON DR	1.00 R
962 074025027	877	CARSON DR	1.00 R
963 074025028	891	CARSON DR	1.00 R
964 074025029	907	CARSON DR	1.00 R
965 074025030	2645	SHADOW LN	1.00 R
966 074026003	503	OAK RIDGE RD	1.00 R
967 074026004	519	OAK RIDGE RD	1.00 R
968 074026005	531	OAK RIDGE RD	1.00 R
969 074026006	532	OAK RIDGE RD	1.00 R
970 074026007	512	OAK RIDGE RD	1.00 R
971 074026008	484	OAK RIDGE RD	1.00 R
972 074026009	537	BROOKLINE CT	1.00 R
973 074026010	534	BROOKLINE CT	1.00 R
974 074026011	593	SPYGLASS RD	1.00 R
975 074026012	609	SPYGLASS RD	1.00 R
976 074026013	538	BROOKLINE CT	1.00 R
977 074026014	622	OAK RIDGE RD	1.00 R
978 074026015	600	OAK RIDGE RD	1.00 R
979 074026016	572	OAK RIDGE RD	1.00 R
980 074026017	604	STANFORD CT	1.00 R
981 074026019	657	SPYGLASS RD	1.00 R
982 074026020	645	SPYGLASS RD	1.00 R
983 074026021	664	SPYGLASS RD	1.00 R
984 074026022	654	SPYGLASS RD	1.00 R
985 074026024	606	SPYGLASS RD	1.00 R
986 074026025	586	SPYGLASS RD	1.00 R
987 074026027	471	OAK RIDGE RD	1.00 R
988 074027001	570	SPYGLASS RD	1.00 R
989 074027002	562	SPYGLASS RD	1.00 R
990 074027003	546	SPYGLASS RD	1.00 R
991 074027004	504	BAYWOOD CT	1.00 R
992 074027005	500	BAYWOOD CT	1.00 R
993 074027006	503	BAYWOOD CT	1.00 R
994 074027007	519	BAYWOOD CT	1.00 R
995 074027010	474	SPYGLASS RD	1.00 R
996 074027011	456	SPYGLASS RD	1.00 R
997 074027012	414	OAK RIDGE CT	1.00 R
998 074027014	384	OAK RIDGE CT	1.00 R
999 074027020	421	SPYGLASS RD	1.00 R
1000 074027021	451	SPYGLASS RD	1.00 R
1001 074027022	495	HAGGIN CT	1.00 R
1002 074027023	503	HAGGIN CT	1.00 R
1003 074027024	496	HAGGIN CT	1.00 R
1004 074027025	480	HAGGIN CT	1.00 R
1005 074027029	569	SPYGLASS RD	1.00 R
1006 074027033	492	SPYGLASS RD	1.00 R
1007 074027034	392	OAK RIDGE CT	1.00 R
1008 074027035	389	OAK RIDGE CT	1.00 R
1009 074027036	401	OAK RIDGE CT	1.00 R
1010 074027037	419	OAK RIDGE CT	1.00 R

1011	074027038	391	SPYGLASS RD	1.00 R
1012	074027040	508	SPYGLASS RD	1.00 R
1013	074029001	845	ST ANDREWS #1	1.00 R
1014	074029002	845	ST ANDREWS #2	1.00 R
1015	074029003	845	ST ANDREWS #3	1.00 R
1016	074029004	845	ST ANDREWS #4	1.00 R
1017	074029005	845	ST ANDREWS #5	1.00 R
1018	074029006	845	ST ANDREWS #6	1.00 R
1019	074029007	845	ST ANDREWS #7	1.00 R
1020	074029008	845	ST ANDREWS #8	1.00 R
1021	074030001	747	ST ANDREWS #2D	1.00 R
1022	074030002	747	ST ANDREWS #2C	1.00 R
1023	074030003	747	ST ANDREWS #2B	1.00 R
1024	074030004	747	ST ANDREWS #2A	1.00 R
1025	074030005	747	ST ANDREWS #1D	1.00 R
1026	074030006	747	ST ANDREWS #1C	1.00 R
1027	074030007	747	ST ANDREWS #1B	1.00 R
1028	074030008	747	ST ANDREWS #1A	1.00 R
1029	074030009	903	ST ANDREWS DR	1.00 R
1030	074030010	905	ST ANDREWS DR	1.00 R
1031	074030011	907	ST ANDREWS DR	1.00 R
1032	074030012	909	ST ANDREWS DR	1.00 R
1033	074030013	911	ST ANDREWS DR	1.00 R
1034	074030014	915	ST ANDREWS #F	1.00 R
1035	074030015	915	ST ANDREWS #G	1.00 R
1036	074030016	915	ST ANDREWS #H	1.00 R
1037	074030017	915	ST ANDREWS #I	1.00 R
1038	074030018	793	ST ANDREWS DR	1.00 R
1039	074030019	791	ST ANDREWS DR	1.00 R
1040	074030020	789	ST ANDREWS DR	1.00 R
1041	074030021	787	ST ANDREWS DR	1.00 R
1042	074030022	785	ST ANDREWS DR	1.00 R
1043	074030023	781	ST ANDREWS DR	1.00 R
1044	074030024	779	ST ANDREWS DR	1.00 R
1045	074030025	777	ST ANDREWS DR	1.00 R
1046	074030026	775	ST ANDREWS DR	1.00 R
1047	074031001	891	ST ANDREWS #1	1.00 R
1048	074031002	891	ST ANDREWS #2	1.00 R
1049	074031003	891	ST ANDREWS #3	1.00 R
1050	074031004	891	ST ANDREWS #4	1.00 R
1051	074031005	891	ST ANDREWS #5	1.00 R
1052	074031006	891	ST ANDREWS #6	1.00 R
1053	074031007	891	ST ANDREWS #7	1.00 R
1054	074031008	891	ST ANDREWS #8	1.00 R
1055	074031009	891	ST ANDREWS #9	1.00 R
1056	074032001	169	GOLDEN WEST CT	1.00 R
1057	074032002	165	GOLDEN WEST CT	1.00 R
1058	074032003	153	GOLDEN WEST CT	1.00 R
1059	074032004	143	GOLDEN WEST CT	1.00 R
1060	074032005	133	GOLDEN WEST CT	1.00 R
1061	074032006	121	GOLDEN WEST CT	1.00 R
1062	074032007	113	GOLDEN WEST CT	1.00 R
1063	074032008	10	JENNIFER CT	1.00 R
1064	074032009	20	JENNIFER COURT	1.00 R
1065	074032010	30	JENNIFER CT	1.00 R
1066	074032013	23	JENNIFER CT	1.00 R
1067	074032014	130	GOLDEN WEST CT	1.00 R
1068	074032015	140	GOLDEN WEST CT	1.00 R
1069	074032016	150	GOLDEN WEST CT	1.00 R
1070	074032018	168	GOLDEN WEST CT	1.00 R

1,111.42

**Occupied Parcels
CCWD, 12/01/2016**

1	???	Road at New Hogan Lake Estates
2	046-001-141	CCWD property
3	046-016-055	Filled - commercial near Valley Springs
4	046-016-065	Filled - commercial near Valley Springs
5	046-019-053	CCWD property
6	046-019-054	CCWD property
7	046-036-025	Filled - commercial near Valley Springs
8	046-036-032	Filled - commercial near Valley Springs
9	046-036-046	Filled - commercial near Valley Springs
10	073-015-038	Public open space or park
11	073-042-091	Golf Course
12	073-042-091	CCWD property
13	073-042-106	CCWD property
14	073-042-107	CCWD property
15	073-042-126	Golf Course
16	073-042-128	CCWD property
17	073-042-130	CCWD property
18	073-042-131	CCWD property
19	073-045-043	Public open space or park
20	073-050-001	Cosgrove Creek
21	073-050-002	Cosgrove Creek
22	073-051-017	Filled parking lot for RVs
23	073-051-036	Public open space or park
24	073-052-037	Public open space or park
25	073-054-010	Public open space or park
26	073-054-016	Public open space or park
27	073-054-038	Public open space or park
28	073-054-063	Public open space or park
29	073-054-063	Public open space or park
30	073-055-026	Public open space or park
31	074-006-014	Cosgrove Creek
32	074-006-017	CCWD property
33	074-006-018	CCWD property
34	074-008-001	CCWD property
35	074-015-031	Public open space or park
36	074-015-032	Public open space or park
37	074-016-027	Public open space or park
38	074-030-028	Filled

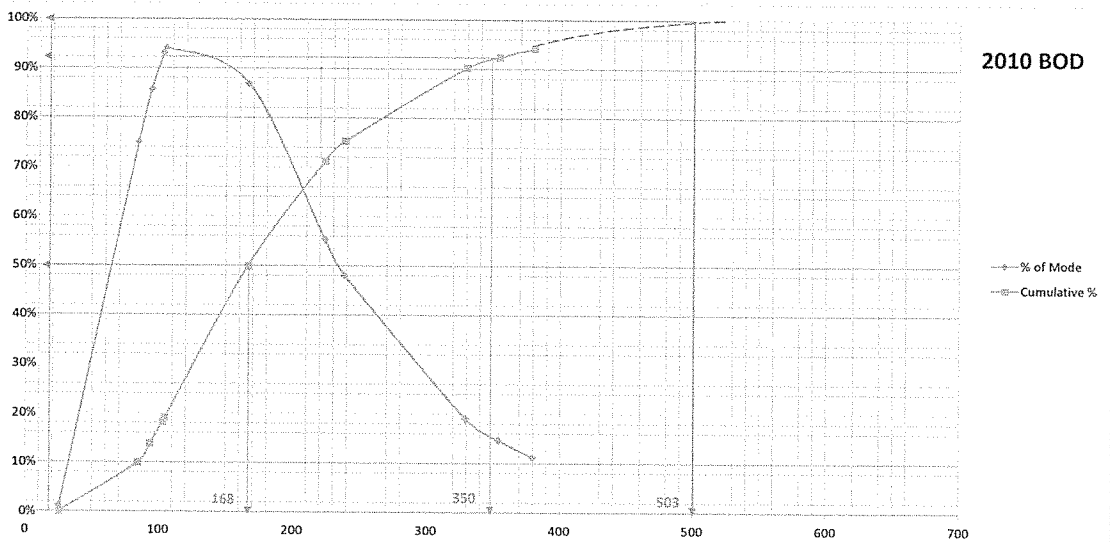
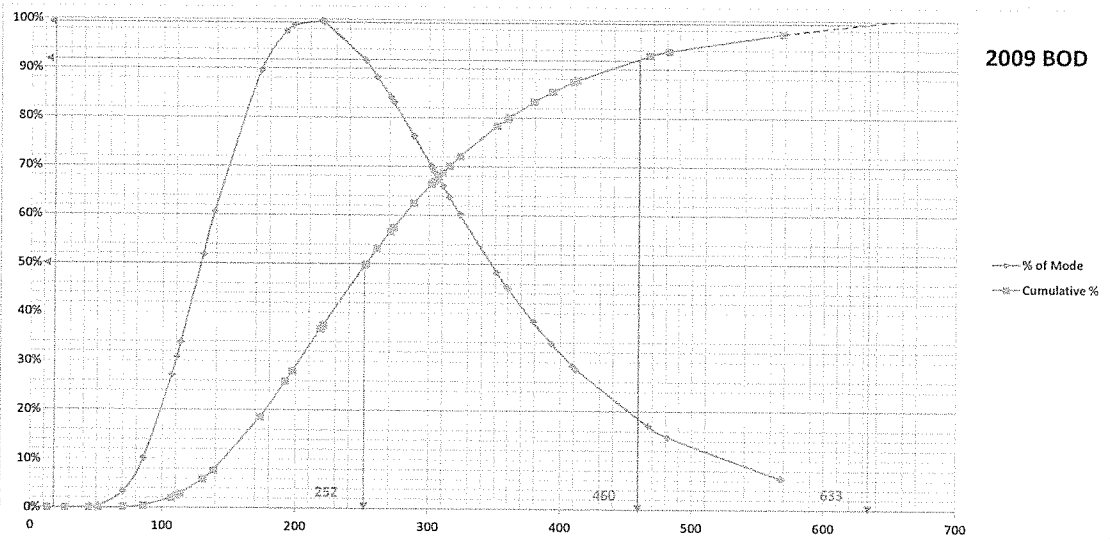
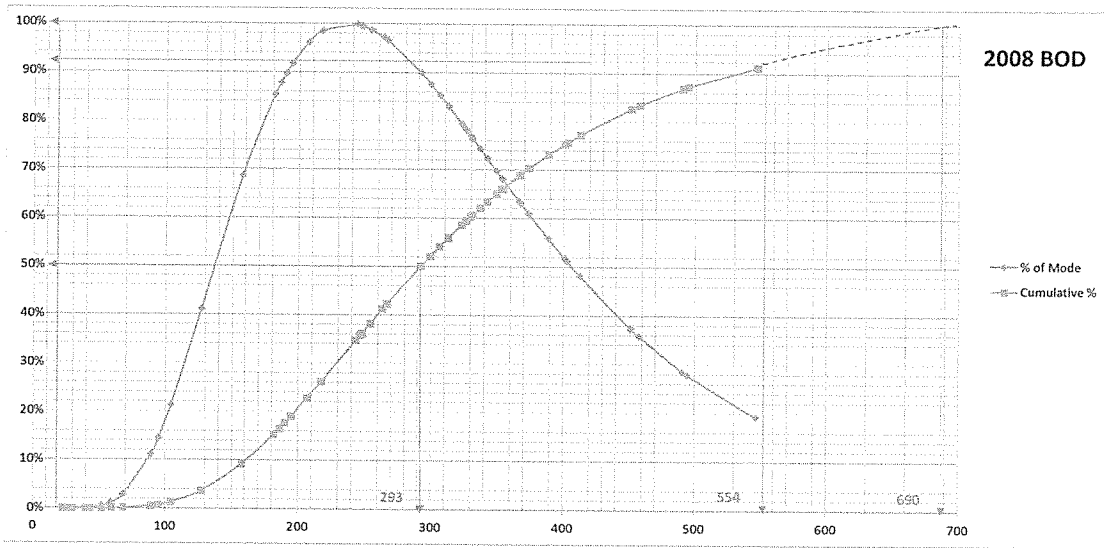

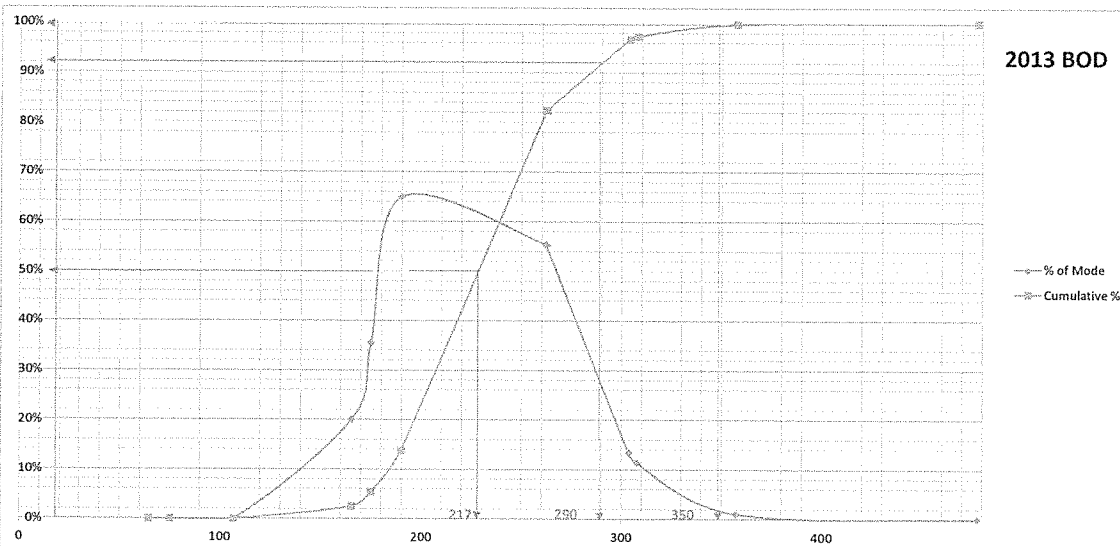
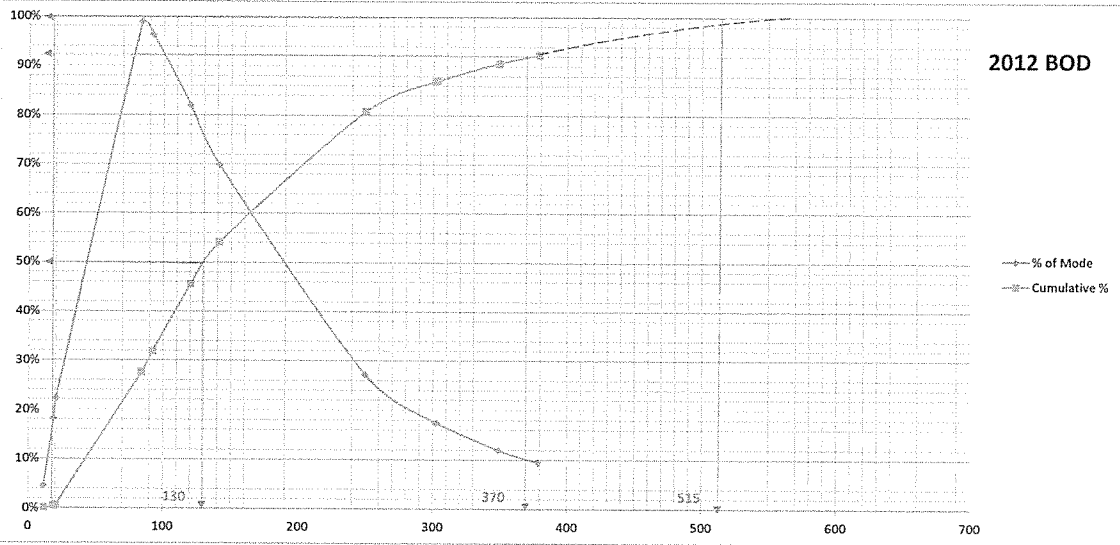
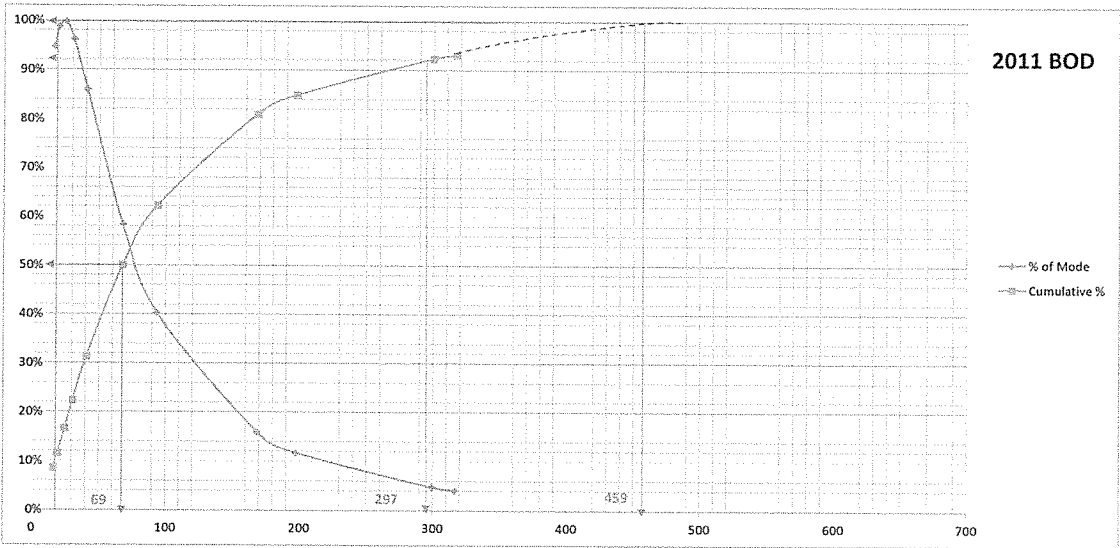

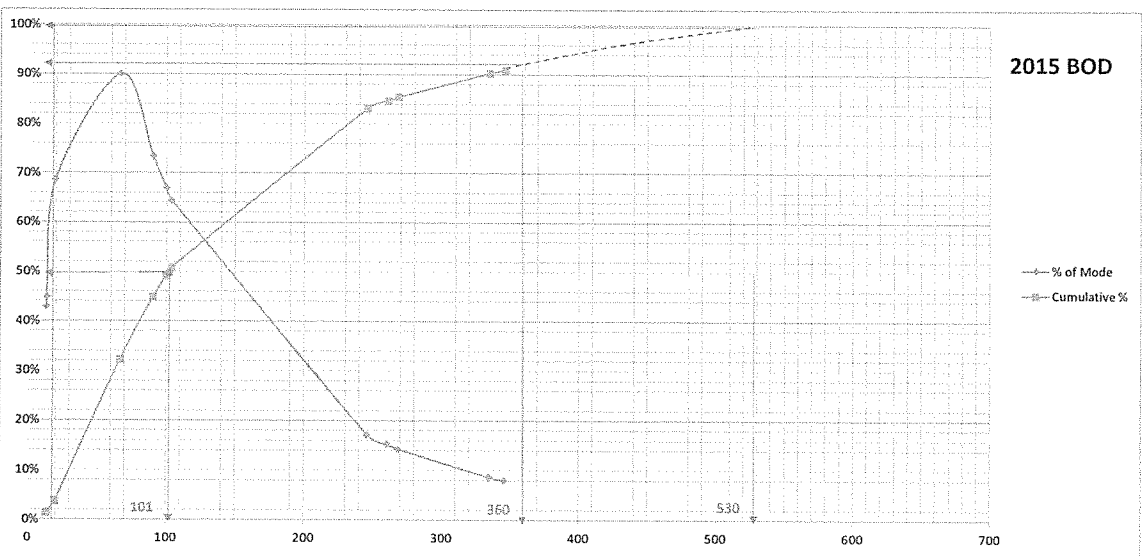
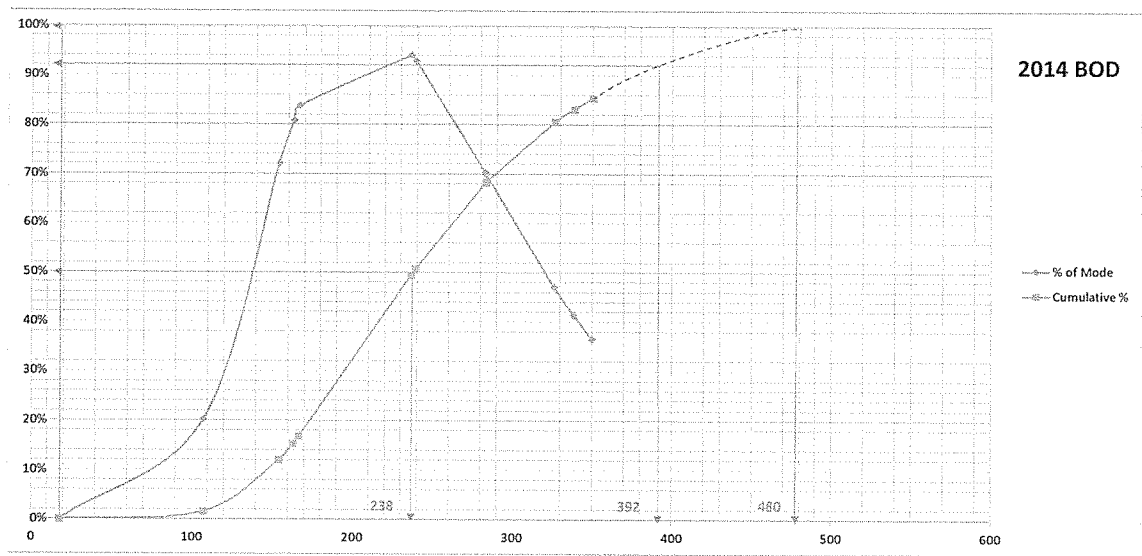

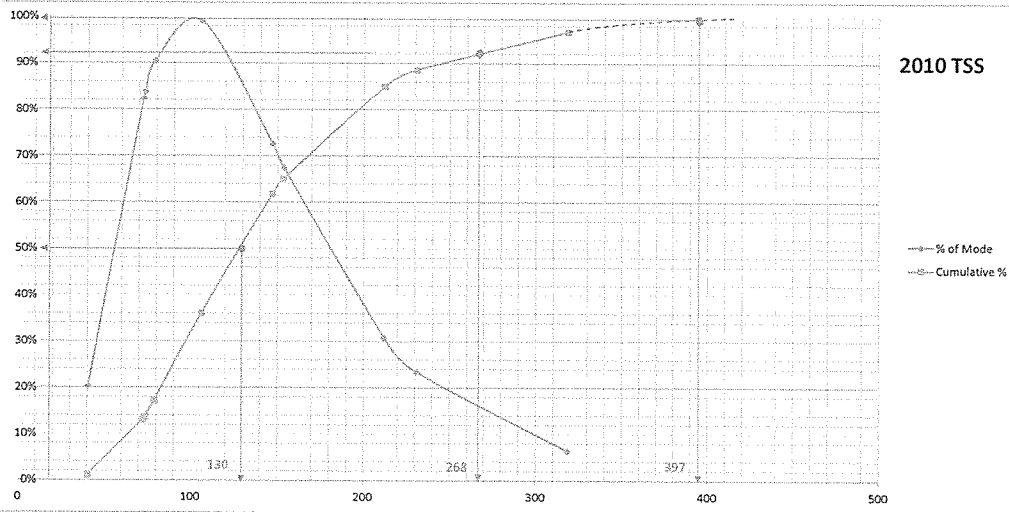
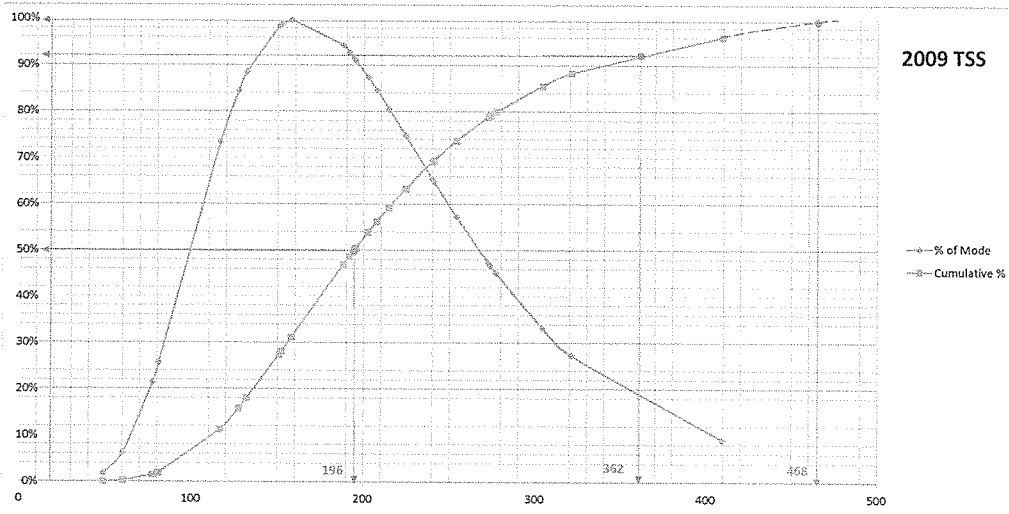
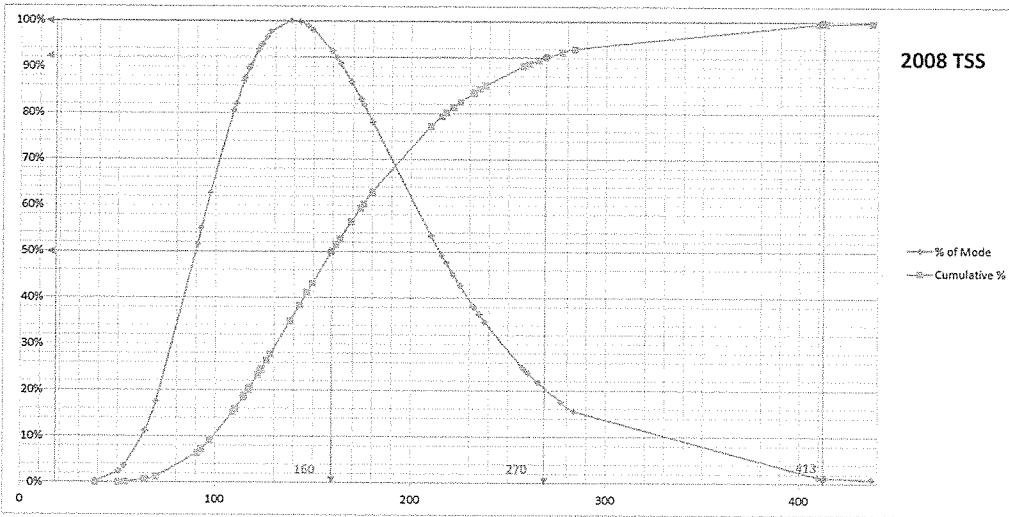

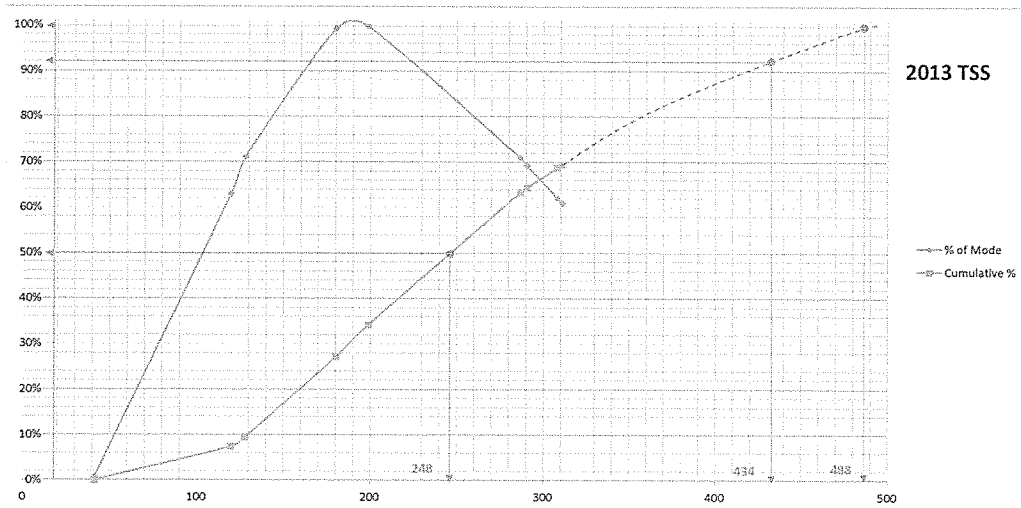
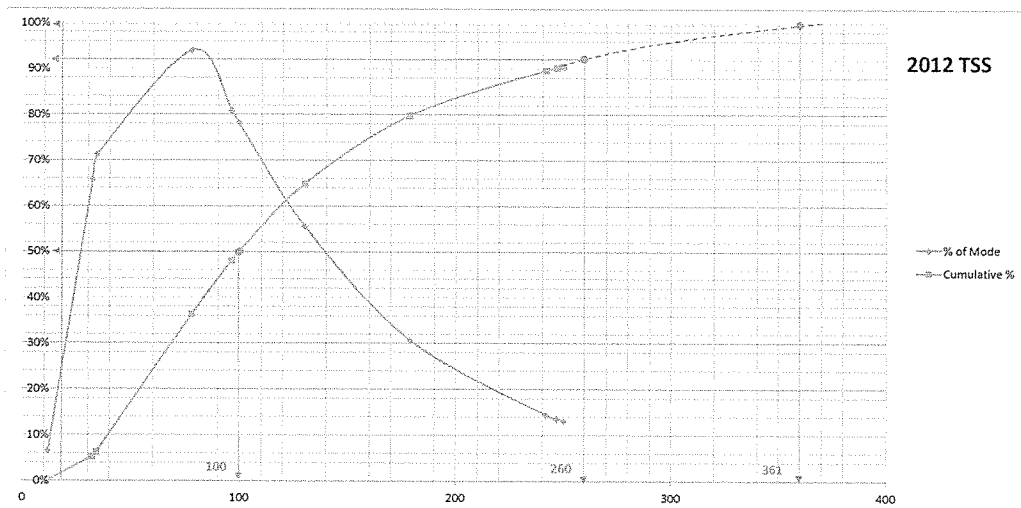
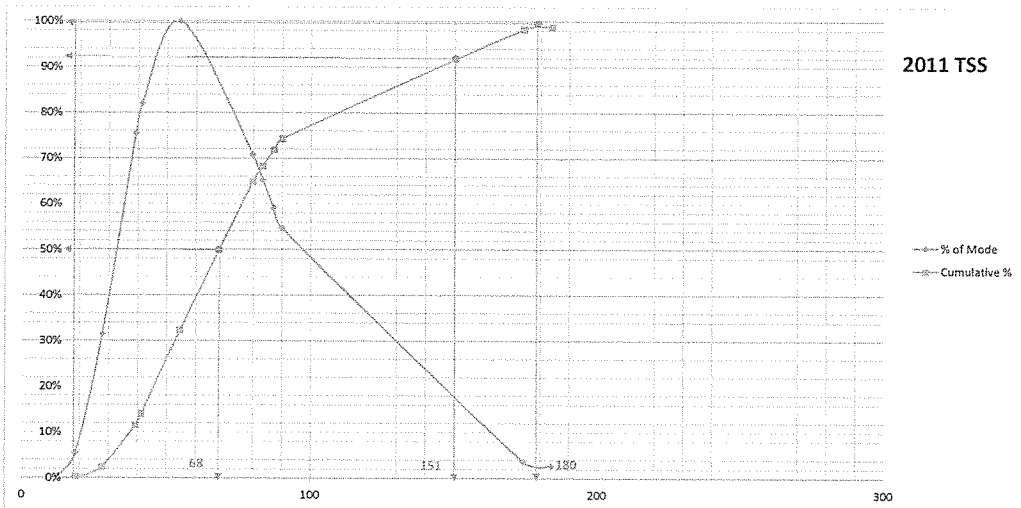



State Water Resources Control Board

Policy for Water Quality Control for Recycled Water (Recycled Water Policy)

Revised January 22, 2013
Effective April 25, 2013



State of California
Edmund G. Brown Jr., Governor

California Environmental Protection Agency
Matthew Rodriguez, Secretary

State Water Resources Control Board
P.O. Box 100
Sacramento, CA 95812-0100

Felicia Marcus, Chair
Frances Spivy-Weber, Vice Chair
Tam M. Doduc, Member
Steven Moore, Member
Dorene D'Adamo, Member

Thomas Howard, Executive Director
Jonathan Bishop, Chief Deputy Director

**STATE WATER RESOURCES CONTROL BOARD
RESOLUTION NO. 2013-0003**

ADOPTION OF AN AMENDMENT TO THE POLICY FOR WATER QUALITY CONTROL FOR
RECYCLED WATER CONCERNING MONITORING REQUIREMENTS FOR
CONSTITUTENTS OF EMERGING CONCERN

WHEREAS:

1. Provisions of the Policy for Water Quality Control for Recycled Water (Recycled Water Policy), adopted under Resolution No. 2009-0011, directed the State Water Resources Control Board (State Water Board) to convene a "blue-ribbon" advisory panel (Panel) to provide guidance on future actions related to monitoring constituents of emerging concern (CECs) in recycled water.
2. In June 2010, the Panel submitted a report titled "Monitoring Strategies for Chemicals of Emerging Concern (CECs) in Recycled Water – Recommendations of a Science Advisory Panel" (Report), which presented recommendations for monitoring CECs in municipal recycled water used for groundwater recharge.
3. In December 2010, the State Water Board held a public hearing regarding the Panel's Report and received public comments.
4. In May 2012, staff circulated a draft amendment to the Recycled Water Policy that: (1) proposed, in accordance with the Panel's recommendations, monitoring requirements for CECs and surrogates in recycled water used for groundwater recharge; and (2) proposed a reduction of priority pollutant monitoring of recycled water used for landscape irrigation.
5. In July 2012, a scientific peer review of the draft amendment and the Panel's Report was conducted.
6. Staff reviewed comments received on the draft amendment from the public and peer reviewers and issued a revised draft amendment on September 14, 2012. Written comments were received on this draft prior to an October 9, 2012, due date.
7. The State Water Board held a public hearing on October 16, 2012, to consider adoption of the draft amendment. At the hearing, the adoption was postponed to refine the responses to comments and allow additional time for public review.
8. The Natural Resources Agency has approved the State Water Board's and the Regional Water Quality Control Boards' water quality control planning process as a "certified regulatory program" that adequately satisfies the California Environmental Quality Act requirements for preparing environmental documents. The amendment concerns monitoring requirements for priority pollutants and constituents of emerging concern. It is not a "project" as defined by title 14, California Code of Regulations chapter 3, Guidelines for Implementation of the California Environmental Quality Act. Hence, approval of an environmental document is not required to adopt the amendment.

THEREFORE BE IT RESOLVED THAT:

The State Water Board

1. Adopts the amendment to the Recycled Water Policy.
2. Directs State Water Board Staff to submit the amended Recycled Water Policy to the Office of Administrative Law (OAL) for final approval.
3. Directs the Executive Director or designee to make minor, non-substantive modifications to the language of the amendment, if OAL determines during its approval process that such changes are needed; and directs the Executive Director to inform the State Water Board of any such changes.

CERTIFICATION

The undersigned Clerk to the Board does hereby certify that the foregoing is a full, true, and correct copy of a resolution duly and regularly adopted at a meeting of the State Water Resources Control Board held on January 22, 2013.

AYE: Vice Chair Frances Spivy-Weber
Board Member Tam M. Doduc
Board Member Steven Moore

NAY: None

ABSENT: Chairman Charles R. Hoppin
Board Member Felicia Marcus

ABSTAIN: None



Jeanine Townsend
Clerk to the Board

Recycled Water Policy

Table of Contents

1. <i>Preamble</i>	1
2. <i>Purpose of the Policy</i>	2
3. <i>Benefits of Recycled Water</i>	3
4. <i>Mandate for the Use of Recycled Water</i>	3
6. <i>Salt/Nutrient Management Plans</i>	5
a. <i>Introduction</i>	5
b. <i>Adoption of Salt/ Nutrient Management Plans.</i>	6
7. <i>Landscape Irrigation Projects</i>	9
a. <i>Control of incidental runoff</i>	9
b. <i>Streamlined Permitting</i>	10
8. <i>Recycled Water Groundwater Recharge Projects</i>	11
9. <i>Antidegradation</i>	12
10. <i>Constituents of Emerging Concern</i>	14
a. <i>General Provisions</i>	14
b. <i>Research Program</i>	14
c. <i>Permit Provisions</i>	16
11. <i>Incentives for the Use of Recycled Water</i>	16
a. <i>Funding</i>	16
b. <i>Stormwater</i>	16
c. <i>TMDLs</i>	16
<u>Attachment A – Monitoring Requirements for Constituents of Emerging Concern</u>	<u>ii</u>
<u>Table of Contents</u>	<u>iii</u>

Recycled Water Policy

1. *Preamble*

California is facing an unprecedented water crisis.

The collapse of the Bay-Delta ecosystem, climate change, and continuing population growth have combined with a severe drought on the Colorado River and failing levees in the Delta to create a new reality that challenges California's ability to provide the clean water needed for a healthy environment, a healthy population and a healthy economy, both now and in the future.

These challenges also present an unparalleled opportunity for California to move aggressively towards a sustainable water future. The State Water Resources Control Board (State Water Board) declares that we will achieve our mission to "preserve, enhance and restore the quality of California's water resources to the benefit of present and future generations." To achieve that mission, we support and encourage every region in California to develop a salt/nutrient management plan by 2014 that is sustainable on a long-term basis and that provides California with clean, abundant water. These plans shall be consistent with the Department of Water Resources' Bulletin 160, as appropriate, and shall be locally developed, locally controlled and recognize the variability of California's water supplies and the diversity of its waterways. We strongly encourage local and regional water agencies to move toward clean, abundant, local water for California by emphasizing appropriate water recycling, water conservation, and maintenance of supply infrastructure and the use of stormwater (including dry-weather urban runoff) in these plans; these sources of supply are drought-proof, reliable, and minimize our carbon footprint and can be sustained over the long-term.

We declare our independence from relying on the vagaries of annual precipitation and move towards sustainable management of surface waters and groundwater, together with enhanced water conservation, water reuse and the use of stormwater. To this end, we adopt the following goals for California:

- Increase the use of recycled water over 2002 levels by at least one million acre-feet per year (afy) by 2020 and by at least two million afy by 2030.
- Increase the use of stormwater over use in 2007 by at least 500,000 afy by 2020 and by at least one million afy by 2030.
- Increase the amount of water conserved in urban and industrial uses by comparison to 2007 by at least 20 percent by 2020.
- Included in these goals is the substitution of as much recycled water for potable water as possible by 2030.

The purpose of this Policy is to increase the use of recycled water from municipal wastewater sources that meets the definition in Water Code section 13050(n), in a manner that implements state and federal water quality laws. The State Water Board expects to develop additional policies to encourage the use of stormwater, encourage water conservation, encourage the conjunctive use of surface and groundwater, and improve the use of local water supplies.

When used in compliance with this Policy, Title 22 and all applicable state and federal water quality laws, the State Water Board finds that recycled water is safe for approved uses, and strongly supports recycled water as a safe alternative to potable water for such approved uses.

2. *Purpose of the Policy*

- a. The purpose of this Policy is to provide direction to the Regional Water Quality Control Boards (Regional Water Boards), proponents of recycled water projects, and the public regarding the appropriate criteria to be used by the State Water Board and the Regional Water Boards in issuing permits for recycled water projects.
- b. It is the intent of the State Water Board that all elements of this Policy are to be interpreted in a manner that fully implements state and federal water quality laws and regulations in order to enhance the environment and put the waters of the state to the fullest use of which they are capable.
- c. This Policy describes permitting criteria that are intended to streamline the permitting of the vast majority of recycled water projects. The intent of this streamlined permit process is to expedite the implementation of recycled water projects in a manner that implements state and federal water quality laws while allowing the Regional Water Boards to focus their limited resources on projects that require substantial regulatory review due to unique site-specific conditions.
- d. By prescribing permitting criteria that apply to the vast majority of recycled water projects, it is the State Water Board's intent to maximize consistency in the permitting of recycled water projects in California while also reserving to the Regional Water Boards sufficient authority and flexibility to address site-specific conditions.
- e. The State Water Board will establish additional policies that are intended to assist the State of California in meeting the goals established in the preamble to this Policy for water conservation and the use of stormwater.

- f. For purposes of this Policy, the term “permit” means an order adopted by a Regional Water Board or the State Water Board prescribing requirements for a recycled water project, including but not limited to water recycling requirements, master reclamation permits, and waste discharge requirements.

3. *Benefits of Recycled Water*

The State Water Board finds that the use of recycled water in accordance with this Policy, that is, which supports the sustainable use of groundwater and/or surface water, which is sufficiently treated so as not to adversely impact public health or the environment and which ideally substitutes for use of potable water, is presumed to have a beneficial impact. Other public agencies are encouraged to use this presumption in evaluating the impacts of recycled water projects on the environment as required by the California Environmental Quality Act (CEQA).

4. *Mandate for the Use of Recycled Water*

- a. The State Water Board and Regional Water Boards will exercise the authority granted to them by the Legislature to the fullest extent possible to encourage the use of recycled water, consistent with state and federal water quality laws.

- (1) The State Water Board hereby establishes a mandate to increase the use of recycled water in California by 200,000 afy by 2020 and by an additional 300,000 afy by 2030. These mandates shall be achieved through the cooperation and collaboration of the State Water Board, the Regional Water Boards, the environmental community, water purveyors and the operators of publicly owned treatment works. The State Water Board will evaluate progress toward these mandates biennially and review and revise as necessary the implementation provisions of this Policy in 2012 and 2016.

- (2) Agencies producing recycled water that is available for reuse and not being put to beneficial use shall make that recycled water available to water purveyors for reuse on reasonable terms and conditions. Such terms and conditions may include payment by the water purveyor of a fair and reasonable share of the cost of the recycled water supply and facilities.

- (3) The State Water Board hereby declares that, pursuant to Water Code sections 13550 *et seq.*, it is a waste and unreasonable use of water for water agencies not to use recycled water when recycled water of adequate quality is available and is not being put to beneficial use, subject to the conditions established in sections 13550 *et seq.* The State Water Board shall exercise its authority pursuant to Water Code section 275 to the fullest extent possible to enforce the mandates of this subparagraph.
 - b. These mandates are contingent on the availability of sufficient capital funding for the construction of recycled water projects from private, local, state, and federal sources and assume that the Regional Water Boards will effectively implement regulatory streamlining in accordance with this Policy.
 - c. The water industry and the environmental community have agreed jointly to advocate for \$1 billion in state and federal funds over the next five years to fund projects needed to meet the goals and mandates for the use of recycled water established in this Policy.
 - d. The State Water Board requests the California Department of Public Health (CDPH), the California Public Utilities Commission (CPUC), and the California Department of Water Resources (CDWR) to use their respective authorities to the fullest extent practicable to assist the State Water Board and the Regional Water Boards in increasing the use of recycled water in California.
5. *Roles of the State Water Board, Regional Water Boards, CDPH and CDWR*

The State Water Board recognizes that it shares jurisdiction over the use of recycled water with the Regional Water Boards and with CDPH. In addition, the State Water Board recognizes that CDWR and the CPUC have important roles to play in encouraging the use of recycled water. The State Water Board believes that it is important to clarify the respective roles of each of these agencies in connection with recycled water projects, as follows:

- a. The State Water Board establishes general policies governing the permitting of recycled water projects consistent with its role of protecting water quality and sustaining water supplies. The State Water Board exercises general oversight over recycled water projects, including review of Regional Water Board permitting practices, and shall lead the effort to meet the recycled water use goals set forth in the Preamble to this Policy. The State Water Board is also charged by statute with developing a general permit for irrigation uses of recycled water.

- b. The CDPH is charged with protection of public health and drinking water supplies and with the development of uniform water recycling criteria appropriate to particular uses of water. Regional Water Boards shall appropriately rely on the expertise of CDPH for the establishment of permit conditions needed to protect human health.
- c. The Regional Water Boards are charged with protection of surface and groundwater resources and with the issuance of permits that implement CDPH recommendations, this Policy, and applicable law and will, pursuant to paragraph 4 of this Policy, use their authority to the fullest extent possible to encourage the use of recycled water.
- d. CDWR is charged with reviewing and, every five years, updating the California Water Plan, including evaluating the quantity of recycled water presently being used and planning for the potential for future uses of recycled water. In undertaking these tasks, CDWR may appropriately rely on urban water management plans and may share the data from those plans with the State Water Board and the Regional Water Boards. CDWR also shares with the State Water Board the authority to allocate and distribute bond funding, which can provide incentives for the use of recycled water.
- e. The CPUC is charged with approving rates and terms of service for the use of recycled water by investor-owned utilities.

6. *Salt/Nutrient Management Plans*

- a. Introduction.
 - (1) Some groundwater basins in the state contain salts and nutrients that exceed or threaten to exceed water quality objectives established in the applicable Water Quality Control Plans (Basin Plans), and not all Basin Plans include adequate implementation procedures for achieving or ensuring compliance with the water quality objectives for salt or nutrients. These conditions can be caused by natural soils/conditions, discharges of waste, irrigation using surface water, groundwater or recycled water and water supply augmentation using surface or recycled water. Regulation of recycled water alone will not address these conditions.
 - (2) It is the intent of this Policy that salts and nutrients from all sources be managed on a basin-wide or watershed-wide basis in a manner that ensures attainment of water quality objectives and protection of beneficial uses. The State Water Board finds that the appropriate way to address salt and nutrient issues is through the development of regional or subregional salt and nutrient management plans

rather than through imposing requirements solely on individual recycled water projects.

b. Adoption of Salt/ Nutrient Management Plans.

(1) The State Water Board recognizes that, pursuant to the letter dated December 19, 2008 and attached to the Resolution adopting this Policy, the local water and wastewater entities, together with local salt/nutrient contributing stakeholders, will fund locally driven and controlled, collaborative processes open to all stakeholders that will prepare salt and nutrient management plans for each basin/sub-basin in California, including compliance with CEQA and participation by Regional Water Board staff.

(a) It is the intent of this Policy for every groundwater basin/sub-basin in California to have a consistent salt/nutrient management plan. The degree of specificity within these plans and the length of these plans will be dependent on a variety of site-specific factors, including but not limited to size and complexity of a basin, source water quality, stormwater recharge, hydrogeology, and aquifer water quality. It is also the intent of the State Water Board that because stormwater is typically lower in nutrients and salts and can augment local water supplies, inclusion of a significant stormwater use and recharge component within the salt/nutrient management plans is critical to the long-term sustainable use of water in California. Inclusion of stormwater recharge is consistent with State Water Board Resolution No. 2005-0006, which establishes sustainability as a core value for State Water Board programs and also assists in implementing Resolution No. 2008-0030, which requires sustainable water resources management and is consistent with Objective 3.2 of the State Water Board Strategic Plan Update dated September 2, 2008.

(b) Salt and nutrient plans shall be tailored to address the water quality concerns in each basin/sub-basin and may include constituents other than salt and nutrients that impact water quality in the basin/sub-basin. Such plans shall address and implement provisions, as appropriate, for all sources of salt and/or nutrients to groundwater basins, including recycled water irrigation projects and groundwater recharge reuse projects.

- (c) Such plans may be developed or funded pursuant to the provisions of Water Code sections 10750 *et seq.* or other appropriate authority.
 - (d) Salt and nutrient plans shall be completed and proposed to the Regional Water Board within five years from the date of this Policy unless a Regional Water Board finds that the stakeholders are making substantial progress towards completion of a plan. In no case shall the period for the completion of a plan exceed seven years.
 - (e) The requirements of this paragraph shall not apply to areas that have already completed a Regional Water Board approved salt and nutrient plan for a basin, sub-basin, or other regional planning area that is functionally equivalent to paragraph 6(b)3.
 - (f) The plans may, depending upon the local situation, address constituents other than salt and nutrients that adversely affect groundwater quality.
- (2) Within one year of the receipt of a proposed salt and nutrient management plan, the Regional Water Boards shall consider for adoption revised implementation plans, consistent with Water Code section 13242, for those groundwater basins within their regions where water quality objectives for salts or nutrients are being, or are threatening to be, exceeded. The implementation plans shall be based on the salt and nutrient plans required by this Policy.
- (3) Each salt and nutrient management plan shall include the following components:
- (a) A basin/sub-basin wide monitoring plan that includes an appropriate network of monitoring locations: The scale of the basin/sub-basin monitoring plan is dependent upon the site-specific conditions and shall be adequate to provide a reasonable, cost-effective means of determining whether the concentrations of salt, nutrients, and other constituents of concern as identified in the salt and nutrient plans are consistent with applicable water quality objectives. Salts, nutrients, and the constituents identified in paragraph 6(b)(1)(f) shall be monitored. The frequency of monitoring shall be determined in the salt/nutrient management plan and approved by the Regional Water Board pursuant to paragraph 6(b)(2).

- (i) The monitoring plan must be designed to determine water quality in the basin. The plan must focus on basin water quality near water supply wells and areas proximate to large water recycling projects, particularly groundwater recharge projects. Also, monitoring locations shall, where appropriate, target groundwater and surface waters where groundwater has connectivity with adjacent surface waters.
 - (ii) The preferred approach to monitoring plan development is to collect samples from existing wells if feasible as long as the existing wells are located appropriately to determine water quality throughout the most critical areas of the basin.
 - (iii) The monitoring plan shall identify those stakeholders responsible for conducting, compiling, and reporting the monitoring data. The data shall be reported to the Regional Water Board at least every three years.
- (b) A provision for annual monitoring of Constituents of Emerging Concern (e.g., endocrine disrupters, personal care products or pharmaceuticals) (CECs) consistent with recommendations by CDPH and consistent with any actions by the State Water Board taken pursuant to paragraph 10(b) of this Policy.
 - (c) Water recycling and stormwater recharge/use goals and objectives.
 - (d) Salt and nutrient source identification, basin/sub-basin assimilative capacity and loading estimates, together with fate and transport of salts and nutrients.
 - (e) Implementation measures to manage salt and nutrient loading in the basin on a sustainable basis.
 - (f) An antidegradation analysis demonstrating that the projects included within the plan will, collectively, satisfy the requirements of Resolution No. 68-16.
- (4) Nothing in this Policy shall prevent stakeholders from developing a plan that is more protective of water quality than applicable standards in the Basin Plan. No Regional Water Board, however, shall seek to modify Basin Plan objectives without full compliance

with the process for such modification as established by existing law.

7. *Landscape Irrigation Projects*¹

- a. *Control of incidental runoff.* Incidental runoff is defined as unintended small amounts (volume) of runoff from recycled water use areas, such as unintended, minimal over-spray from sprinklers that escapes the recycled water use area. Water leaving a recycled water use area is not considered incidental if it is part of the facility design, if it is due to excessive application, if it is due to intentional overflow or application, or if it is due to negligence. Incidental runoff may be regulated by waste discharge requirements or, where necessary, waste discharge requirements that serve as a National Pollutant Discharge Elimination System (NPDES) permit, including municipal separate storm water system permits, but regardless of the regulatory instrument, the project shall include, but is not limited to, the following practices:
- (1) Implementation of an operations and management plan that may apply to multiple sites and provides for detection of leaks, (for example, from broken sprinkler heads), and correction either within 72 hours of learning of the runoff, or prior to the release of 1,000 gallons, whichever occurs first,
 - (2) Proper design and aim of sprinkler heads,
 - (3) Refraining from application during precipitation events, and
 - (4) Management of any ponds containing recycled water such that no discharge occurs unless the discharge is a result of a 25-year, 24-hour storm event or greater, and there is notification of the appropriate Regional Water Board Executive Officer of the discharge.

¹ Specified uses of recycled water considered "landscape irrigation" projects include any of the following:

- i. Parks, greenbelts, and playgrounds;
- ii. School yards;
- iii. Athletic fields;
- iv. Golf courses;
- v. Cemeteries;
- vi. Residential landscaping, common areas;
- vii. Commercial landscaping, except eating areas;
- viii. Industrial landscaping, except eating areas; and
- ix. Freeway, highway, and street landscaping.

b. *Streamlined Permitting.*

- (1) The Regional Water Boards shall, absent unusual circumstances (i.e., unique, site-specific conditions such as where recycled water is proposed to be used for irrigation over high transmissivity soils over a shallow (5' or less) high quality groundwater aquifer), permit recycled water projects that meet the criteria set forth in this Policy, consistent with the provisions of this paragraph.
- (2) If the Regional Water Board determines that unusual circumstances apply, the Regional Water Board shall make a finding of unusual circumstances based on substantial evidence in the record, after public notice and hearing.
- (3) Projects meeting the criteria set forth below and eligible for enrollment under requirements established in a general order shall be enrolled by the State or Regional Water Board within 60 days from the date on which an application is deemed complete by the State or Regional Water Board. For projects that are not enrolled in a general order, the Regional Water Board shall consider permit adoption within 120 days from the date on which the application is deemed complete by the Regional Water Board.
- (4) Landscape irrigation projects that qualify for streamlined permitting shall not be required to include a project specific receiving water and groundwater monitoring component unless such project specific monitoring is required under the adopted salt/nutrient management plan. During the interim while the salt management plan is under development, a landscape irrigation project proponent can either perform project specific monitoring, or actively participate in the development and implementation of a salt/nutrient management plan, including basin/sub-basin monitoring. Permits or requirements for landscape irrigation projects shall include, in addition to any other appropriate recycled water monitoring requirements, monitoring for priority pollutants in the recycled water at the recycled water production facility once per year, except when the recycled water production facility has a design production flow for the entire water reuse system of one million gallons per day or less. For these smaller facilities, the recycled water shall be monitored for priority pollutants once every five years.
- (5) It is the intent of the State Water Board that the general permit for landscape irrigation projects be consistent with the terms of this Policy.

- c. *Criteria for streamlined permitting.* Irrigation projects using recycled water that meet the following criteria are eligible for streamlined permitting, and, if otherwise in compliance with applicable laws, shall be approved absent unusual circumstances:
- (1) Compliance with the requirements for recycled water established in Title 22 of the California Code of Regulations, including the requirements for treatment and use area restrictions, together with any other recommendations by CDPH pursuant to Water Code section 13523.
 - (2) Application in amounts and at rates as needed for the landscape (i.e., at agronomic rates and not when the soil is saturated). Each irrigation project shall be subject to an operations and management plan, that may apply to multiple sites, provided to the Regional Water Board that specifies the agronomic rate(s) and describes a set of reasonably practicable measures to ensure compliance with this requirement, which may include the development of water budgets for use areas, site supervisor training, periodic inspections, tiered rate structures, the use of smart controllers, or other appropriate measures.
 - (3) Compliance with any applicable salt and nutrient management plan.
 - (4) Appropriate use of fertilizers that takes into account the nutrient levels in the recycled water. Recycled water producers shall monitor and communicate to the users the nutrient levels in their recycled water.

8. *Recycled Water Groundwater Recharge Projects*

- a. The State Water Board acknowledges that all recycled water groundwater recharge projects must be reviewed and permitted on a site-specific basis, and so such projects will require project-by-project review.
- b. Approved groundwater recharge projects will meet the following criteria:
 - (1) Compliance with regulations adopted by CDPH for groundwater recharge projects or, in the interim until such regulations are approved, CDPH's recommendations pursuant to Water Code section 13523 for the project (e.g., level of treatment, retention time, setback distance, source control, monitoring program, etc.).
 - (2) Implementation of a monitoring program for CECs that is consistent with Attachment A and any recommendations from CDPH.

Groundwater recharge projects shall include monitoring of recycled water for priority pollutants twice per year.

- c. Nothing in this paragraph shall be construed to limit the authority of a Regional Water Board to protect designated beneficial uses, *provided* that any proposed limitations for the protection of public health may only be imposed following regular consultation by the Regional Water Board with CDPH, consistent with State Water Board Orders WQ 2005-0007 and 2006-0001.
- d. Nothing in this Policy shall be construed to prevent a Regional Water Board from imposing additional requirements for a proposed recharge project that has a substantial adverse effect on the fate and transport of a contaminant plume or changes the geochemistry of an aquifer thereby causing the dissolution of constituents, such as arsenic, from the geologic formation into groundwater.
- e. Projects that utilize surface spreading to recharge groundwater with recycled water treated by reverse osmosis shall be permitted by a Regional Water Board within one year of receipt of recommendations from CDPH. Furthermore, the Regional Water Board shall give a high priority to review and approval of such projects.

9. *Antidegradation*

- a. The State Water Board adopted Resolution No. 68-16 as a policy statement to implement the Legislature's intent that waters of the state shall be regulated to achieve the highest water quality consistent with the maximum benefit to the people of the state.
- b. Activities involving the disposal of waste that could impact high quality waters are required to implement best practicable treatment or control of the discharge necessary to ensure that pollution or nuisance will not occur, and the highest water quality consistent with the maximum benefit to the people of the state will be maintained.
- c. Groundwater recharge with recycled water for later extraction and use in accordance with this Policy and state and federal water quality law is to the benefit of the people of the state of California. Nonetheless, the State Water Board finds that groundwater recharge projects using recycled water have the potential to lower water quality within a basin. The proponent of a groundwater recharge project must demonstrate compliance with Resolution No. 68-16. Until such time as a salt/nutrient management plan is in effect, such compliance may be demonstrated as follows:

- (1) A project that utilizes less than 10 percent of the available assimilative capacity in a basin/sub-basin (or multiple projects utilizing less than 20 percent of the available assimilative capacity in a basin/sub-basin) need only conduct an antidegradation analysis verifying the use of the assimilative capacity. For those basins/sub-basins where the Regional Water Boards have not determined the baseline assimilative capacity, the baseline assimilative capacity shall be calculated by the initial project proponent, with review and approval by the Regional Water Board, until such time as the salt/nutrient plan is approved by the Regional Water Board and is in effect. For compliance with this subparagraph, the available assimilative capacity shall be calculated by comparing the mineral water quality objective with the average concentration of the basin/sub-basin, either over the most recent five years of data available or using a data set approved by the Regional Water Board Executive Officer. In determining whether the available assimilative capacity will be exceeded by the project or projects, the Regional Water Board shall calculate the impacts of the project or projects over at least a ten year time frame.
 - (2) In the event a project or multiple projects utilize more than the fraction of the assimilative capacity designated in subparagraph (1), then a Regional Water Board-deemed acceptable antidegradation analysis shall be performed to comply with Resolution No. 68-16. The project proponent shall provide sufficient information for the Regional Water Board to make this determination. An example of an approved method is the method used by the State Water Board in connection with Resolution No. 2004-0060 and the Regional Water Board in connection with Resolution No. R8-2004-0001. An integrated approach (using surface water, groundwater, recycled water, stormwater, pollution prevention, water conservation, etc.) to the implementation of Resolution No. 68-16 is encouraged.
- d. Landscape irrigation with recycled water in accordance with this Policy is to the benefit of the people of the State of California. Nonetheless, the State Water Board finds that the use of water for irrigation may, regardless of its source, collectively affect groundwater quality over time. The State Water Board intends to address these impacts in part through the development of salt/nutrient management plans described in paragraph 6.
- (1) A project that meets the criteria for a streamlined irrigation permit and is within a basin where a salt/nutrient management plan satisfying the provisions of paragraph 6(b) is in place may be

approved without further antidegradation analysis, provided that the project is consistent with that plan.

- (2) A project that meets the criteria for a streamlined irrigation permit and is within a basin where a salt/nutrient management plan satisfying the provisions of paragraph 6(b) is being prepared may be approved by the Regional Water Board by demonstrating through a salt/nutrient mass balance or similar analysis that the project uses less than 10 percent of the available assimilative capacity as estimated by the project proponent in a basin/sub-basin (or multiple projects using less than 20 percent of the available assimilative capacity as estimated by the project proponent in a basin/sub-basin).

10. *Constituents of Emerging Concern*

a. General Provisions

- (1) Regulatory requirements for recycled water shall be based on the best available peer-reviewed science. In addition, all uses of recycled water must meet conditions set by CDPH.
- (2) Knowledge of risks will change over time and recycled water projects must meet legally applicable criteria. However, when standards change, projects should be allowed time to comply through a compliance schedule.
- (3) The state of knowledge regarding CECs is incomplete. There needs to be additional research and development of analytical methods and surrogates to determine potential environmental and public health impacts. Agencies should minimize the likelihood of CECs impacting human health and the environment by means of source control and/or pollution prevention programs.
- (4) Regulating most CECs will require significant work to develop test methods and more specific determinations as to how and at what level CECs impact public health or our environment.

b. Research Program

- (1) The State Water Board, in consultation with CDPH, convened a "blue-ribbon" advisory panel to guide future actions relating to CECs.

- (a) The panel was actively managed by the State Water Board and was composed of the following: one human health toxicologist, one environmental toxicologist, one epidemiologist, one biochemist, one civil engineer familiar with the design and construction of recycled water treatment facilities, and one chemist familiar with the design and operation of advanced laboratory methods for the detection of emerging constituents. Each of these panelists had extensive experience as a principal investigator in their respective areas of expertise.
 - (b) The panel reviewed the scientific literature and submitted a report to the State Water Board and CDPH that described the current state of scientific knowledge regarding the risks of CECs to public health and the environment. In December 2010, the State Water Board, in coordination with CDPH, held a public hearing to hear a presentation on the report and to receive comments from stakeholders.
 - (c) The State Water Board considered the panel report and the comments received and adopted an amendment to the Policy establishing monitoring requirements for CECs in recycled water. These monitoring requirements are prescribed in Attachment A.
- (2) The panel or a similarly constituted panel shall update the report every five years. The next update is due in June 2015.
- (a) Each updated report shall recommend actions that the State of California should take to improve our understanding of CECs and, as may be appropriate, to protect public health and the environment.
 - (b) The updated reports shall answer the following questions: What are the appropriate constituents to be monitored in recycled water, including analytical methods and method detection limits? What is the known toxicological information for the above constituents? Would the above lists change based on level of treatment and use? If so, how? What are possible indicators that represent a suite of CECs? What levels of CEC's should trigger enhanced monitoring of CEC's in recycled water, groundwater and/or surface waters?
 - (c) Within six months from receipt of an updated report, the State Water Board shall hold a hearing to consider recommendations from staff and shall endorse the

recommendations, as appropriate, after making any necessary modifications.

c. Permit Provisions

Permits for recycled water projects shall be consistent with any CDPH recommendations to protect public health and the monitoring requirements prescribed in Attachment A.

11. *Incentives for the Use of Recycled Water*

a. Funding

The State Water Board will request CDWR to provide priority funding for projects that have major recycling components; particularly those that decrease demand on potable water supplies. The State Water Board will also request priority funding for stormwater recharge projects that augment local water supplies. The State Water Board shall promote the use of the State Revolving Fund (SRF) for water purveyor, stormwater agencies, and water recyclers to use for water reuse and stormwater use and recharge projects.

b. Stormwater

The State Water Board strongly encourages all water purveyors to provide financial incentives for water recycling and stormwater recharge and reuse projects. The State Water Board also encourages the Regional Water Boards to require less stringent monitoring and regulatory requirements for stormwater treatment and use projects than for projects involving untreated stormwater discharges.

c. TMDLs

Water recycling reduces mass loadings from municipal wastewater sources to impaired waters. As such, waste load allocations shall be assigned as appropriate by the Regional Water Boards in a manner that provides an incentive for greater water recycling.

ATTACHMENT A

Requirements for Monitoring Constituents of Emerging Concern in Recycled Water

Table of Contents

REQUIREMENTS FOR MONITORING CONSTITUENTS OF EMERGING CONCERN ...	A-1
1. CECS AND SURROGATES.....	A-2
1.1. CECS for Monitoring Programs	A-3
Table 1 – CECS to be Monitored	A-4
1.2. Surrogates for Monitoring Programs.....	A-5
2. MONITORING LOCATIONS	A-5
2.1. Health-Based CEC Monitoring Locations.....	A-5
2.1.1. Groundwater Recharge Reuse - Surface Application	A-5
2.1.2. Groundwater Recharge Reuse - Subsurface Application.....	A-6
2.2. Performance Indicator CEC and Surrogate Monitoring Locations	A-6
2.2.1. Groundwater Recharge Reuse - Surface Application	A-6
2.2.2. Groundwater Recharge Reuse - Subsurface Application.....	A-6
3. PHASED MONITORING REQUIREMENTS	A-7
3.1. Initial Assessment Monitoring Phase	A-7
3.2. Baseline Monitoring Phase	A-8
Table 3: Initial Assessment Phase Monitoring Requirements	A-10
Table 4: Baseline Phase Monitoring Requirements	A-11
3.3. Standard Operation Monitoring	A-12
Table 5: Standard Operation Monitoring Requirement	A-13
4. EVALUATION OF CEC AND SURROGATE MONITORING RESULTS.....	A-14
4.1 Evaluation of Performance Indicator CEC and Surrogate Results.....	A-14
4.1.1. Groundwater Recharge Reuse – Surface Application	A-14
4.1.2. Groundwater Recharge Reuse – Subsurface Application.....	A-15
Table 6: Monitoring Trigger Levels and Removal Percentages	A-16
4.2. Evaluation of Health-Based CEC Results	A-17

ATTACHMENT A

**REQUIREMENTS FOR MONITORING
CONSTITUENTS OF EMERGING CONCERN
FOR RECYCLED WATER**

The purpose of this attachment to the Recycled Water Policy (Policy) is to provide direction to the Regional Water Quality Control Boards (Regional Water Boards) on monitoring requirements for constituents of emerging concern² (CECs) in recycled municipal wastewater, herein referred to as “recycled water.” The monitoring requirements and criteria for evaluating monitoring results in the Policy are based on recommendations from a Science Advisory Panel³. The monitoring requirements pertain to the production and use of recycled water for groundwater recharge reuse⁴ by surface and subsurface application methods. The monitoring requirements apply to recycled water producers, including entities that further treat or enhance the quality of recycled water supplied by municipal wastewater treatment facilities, and groundwater recharge reuse facilities.

Groundwater recharge by surface application is the controlled application of water to a spreading area for infiltration resulting in the recharge of a groundwater basin. Subsurface application is the controlled application of water to a groundwater basin or aquifer by a means other than surface application, such as direct injection through a well.

The California Department of Public Health (CDPH) shall be consulted for any additional monitoring requirements for recycled water use found necessary by CDPH to protect human health.

² For this Policy, CECs are defined to be chemicals in personal care products, pharmaceuticals including antibiotics, antimicrobials; industrial, agricultural, and household chemicals; hormones; food additives; transformation products, inorganic constituents; and nanomaterials.

³ The Science Advisory Panel was convened in accordance with provision 10.b. of the Policy. The panel’s recommendations were presented in the report; *Monitoring Strategies for Chemicals of Emerging Concern (CECs) in Recycled Water – Recommendations of a Science Advisory Panel*, dated June 25, 2010.

⁴ As used in this attachment, use of recycled water for groundwater recharge reuse has the same meaning as indirect potable reuse for groundwater recharge as defined in Water Code section 13561(c), where it is defined as the planned use of recycled water for replenishment of a groundwater basin or an aquifer that has been designated as a source of water supply for a public water system.

1. CECS AND SURROGATES

Within this Policy, CECs of toxicological relevance to human health are referred to as “health-based CECs.”⁵ CECs determined not to have human health relevance, but useful for monitoring treatment process effectiveness, are referred to as “performance indicator CECs.” A performance indicator CEC is an individual CEC used for evaluating a family of CECs with similar physicochemical or biodegradable characteristics. The removal of a performance indicator CEC through a treatment process provides an indication of removal of CECs with similar properties. A health-based CEC may also serve as a performance indicator CEC.

A surrogate is a measurable physical or chemical property, such as chlorine residual or electrical conductivity, that can be used to measure the effectiveness of trace organic compound removal by treatment process and/or provide an indication of a treatment process failure. A reverse osmosis (RO) treatment process, for example, is expected to substantially reduce the electrical conductivity of the recycled water being treated. This reduction in the level of the surrogate also provides an indication that inorganic and organic compounds, including CECs, are being removed.

Recycled water monitoring programs used for groundwater recharge reuse shall include monitoring for: (1) human health-based CECs; (2) performance indicator CECs; and (3) surrogates. The purpose of monitoring performance indicator CECs and surrogates is to assess the effectiveness of unit processes to remove CECs. For this policy for groundwater recharge reuse, unit processes that remove CECs include RO, advanced oxidation processes (AOPs), and soil aquifer treatment.⁶ AOPs are treatment processes involving the use of oxidizing agents, such as hydrogen peroxide and ozone, combined with ultraviolet light irradiation. Soil aquifer treatment is a natural treatment process that removes CECs as water passes through soil, the vadose zone, and within an aquifer.

This Policy provides CEC monitoring requirements for recycled water which undergoes additional treatment by soil aquifer treatment or by RO followed by AOPs. CEC monitoring requirements for groundwater recharge reuse projects implementing treatment processes that provide control of CECs by processes other than soil aquifer treatment or RO/AOPs shall be established on a case-by-case basis by the State Water Board in consultation with CDPH.

⁵ Health-based CECs were determined through a screening process that was developed and conducted by the CEC Science Advisory Panel; *Monitoring Strategies for Chemicals of Emerging Concern (CECs) in Recycled Water – Recommendations of a Science Advisory Panel*, dated June 25, 2010.

⁶ For evaluating removal of CECs, the treatment zone for soil aquifer treatment is from the surface of the application area through the unsaturated zone to groundwater, including groundwater within a 30-day travel time distance through the aquifer downgradient of the surface application area.

Monitoring of health-based CECs or performance indicator CECs is not required for recycled water used for landscape irrigation due to the low risk for ingestion of the water.⁷

1.1. CECs for Monitoring Programs

This Policy provides requirements for monitoring CECs in recycled water used for groundwater recharge reuse. The Regional Water Boards shall not issue requirements for monitoring of additional CECs in recycled water beyond the requirements provided in this Policy except when recommended by CDPH or requested by the project proponent.

Table 1 provides the health-based CECs and performance indicator CECs to be monitored along with their respective reporting limits. All CECs listed for a recycled water application shall be monitored during an initial assessment monitoring phase, as described in Section 3.1. Based on monitoring results and findings, the list of performance indicator CECs required for monitoring may be refined for subsequent monitoring phases. The health-based CECs listed in Table 1 shall be monitored during the entirety of the initial assessment and baseline monitoring phases (Sections 3.1 and 3.2). Based on the results of the baseline monitoring phase and/or subsequent monitoring, the list of health-based CECs required for monitoring may be revised. The method for evaluation of monitoring results for health-based CECs is provided in Section 4.2.

Quality assurance and quality control measures shall be used for both collection of samples and laboratory analysis work. The project proponent shall develop a quality assurance project plan that includes the appropriate number of field blanks, laboratory blanks, replicate samples, and matrix spikes.

⁷ "For monitoring programs to assess CEC threats for urban irrigation reuse, none of the chemicals for which measurement methods and exposure data are available exceeded the threshold for monitoring priority. This is largely attributable to higher Monitoring Trigger Levels (MTLs), because of reduced water ingestion in a landscape irrigation setting compared to drinking water." MTLs are health-based screening level values for CECs for a particular water reuse scenario. MTLs were established in, *Monitoring Strategies for Chemicals of Emerging Concern (CECs) in Recycled Water – Recommendations of a Science Advisory Panel*, dated June 25, 2010.

Table 1 – CECs to be Monitored

<u>Constituent</u>	<u>Constituent Group</u>	<u>Relevance/Indicator Type</u>	<u>Reporting Limit (µg/L)</u>
GROUNDWATER RECHARGE REUSE - SURFACE APPLICATION			
17β-estradiol	Steroid hormones	Health	0.001
Caffeine	Stimulant	Health & Performance	0.05
N-Nitrosodimethylamine (NDMA)	Disinfection byproduct	Health	0.002
Triclosan	Antimicrobial	Health	0.05
Gemfibrozil	Pharmaceutical	Performance	0.01
Iopromide	Pharmaceutical	Performance	0.05
N,N-Diethyl-meta-toluamide (DEET)	Personal care product	Performance	0.05
Sucralose	Food additive	Performance	0.1
GROUNDWATER RECHARGE REUSE - SUBSURFACE APPLICATION			
17β-estradiol	Steroid hormones	Health	0.001
Caffeine	Stimulant	Health & Performance	0.05
NDMA	Disinfection byproduct	Health & Performance	0.002
Triclosan	Antimicrobial	Health	0.05
DEET	Personal care product	Performance	0.05
Sucralose	Food additive	Performance	0.1

µg/L – Micrograms per liter

Analytical methods for laboratory analysis of CECs shall be selected to achieve the reporting limits presented in Table 1. The analytical methods shall be based on methods published by the United States Environmental Protection Agency, methods certified by CDPH, or peer reviewed and published methods that have been reviewed by CDPH, including those published by voluntary consensus standards bodies such as the Standards Methods Committee and the American Society for Testing and Materials International. Any modifications to the published or certified methods shall be reviewed by CDPH and subsequently submitted to the Regional Water Board in an updated quality assurance project plan.

1.2. Surrogates for Monitoring Programs

Table 2 presents a list of surrogates that shall be considered for monitoring treatment of recycled water used for groundwater recharge reuse. Other surrogates not listed in Table 2 may also be considered.

Table 2: Surrogates

GROUNDWATER RECHARGE REUSE - SURFACE APPLICATION
Ammonia
Total Organic Carbon (TOC)
Nitrate
Ultraviolet (UV) Light Absorption
GROUNDWATER RECHARGE REUSE - SUBSURFACE APPLICATION
Electrical Conductivity
TOC

The project proponent shall propose surrogates to monitor on a case-by-case basis appropriate for the treatment process or processes. The Regional Water Board shall review and approve the selected surrogates in consultation with CDPH.

Where applicable, surrogates may be measured using on-line or hand-held instruments provided that instrument calibration procedures are implemented in accordance with the manufacturer's specifications and that calibration is documented.

2. MONITORING LOCATIONS

Monitoring locations for CECs and surrogates are described in this section.

2.1. Health-Based CEC Monitoring Locations

2.1.1. Groundwater Recharge Reuse - Surface Application

For groundwater recharge reuse projects implementing surface application of recycled water, health-based CECs shall be monitored at these locations:

- (1) Following tertiary treatment⁸ prior to application to the surface spreading area; and
- (2) At monitoring well locations designated in consultation with CDPH within the distance groundwater travels downgradient from the application site in 30 days. Monitoring locations for health-based CECs for the phases of monitoring are presented in Tables 3 through 5.

2.1.2. Groundwater Recharge Reuse - Subsurface Application

For groundwater recharge reuse projects implementing subsurface application of recycled water, health-based CECs shall be monitored at a location following treatment prior to release into an aquifer.

2.2. Performance Indicator CEC and Surrogate Monitoring Locations

To allow evaluation of individual unit processes or a combination of unit processes that provide removal of CECs, performance indicator CECs and surrogates shall be monitored at the locations described below and presented in Tables 3 through 5.

2.2.1. Groundwater Recharge Reuse - Surface Application

For groundwater recharge reuse projects using surface application of recycled water, performance indicator CECs and surrogates shall be monitored at these locations:

- (1) Following tertiary treatment prior to application to the surface spreading area; and
- (2) At monitoring well locations designated in consultation with CDPH within the distance groundwater travels downgradient from the application site in 30 days.

Monitoring locations for performance indicator CECs and surrogates for the phases of monitoring are presented in Tables 3 through 5.

2.2.2. Groundwater Recharge Reuse - Subsurface Application

For groundwater recharge reuse projects using subsurface application of recycled water, performance indicator CECs shall be monitored in recycled water at these locations:

- (1) Prior to treatment by RO; and

⁸ Standards for disinfected tertiary recycled water presented in California Code of Regulations, Title 22, section 60301.230 and 60301.320.

(2) Following treatment prior to release to the aquifer.

If the project proponent can demonstrate that the RO unit will not substantially remove a CEC, the Regional Water Board may allow monitoring for that CEC prior to the AOPs, instead of prior to the RO unit.

For groundwater recharge reuse projects using subsurface application of recycled water, surrogates shall be monitored at locations proposed by the project proponent and approved by the Regional Water Board in consultation with CDPH.

3. PHASED MONITORING REQUIREMENTS

The Regional Water Board shall phase the monitoring requirements for CECs and surrogates for groundwater recharge reuse projects. The purpose of phased monitoring is to allow monitoring requirements for health-based CECs, performance indicator CECs and surrogates to be refined based on the monitoring results and findings of the previous phase. An initial assessment monitoring phase, followed by a baseline monitoring phase, shall be conducted to determine the project-specific monitoring requirements for standard operations. The initial assessment and baseline monitoring phases shall be conducted after CDPH approval for groundwater recharge reuse project operation.

3.1. Initial Assessment Monitoring Phase

The purposes of the initial assessment phase are to: (1) identify the occurrence of health-based CECs, performance indicator CECs, and surrogates in recycled water and groundwater;⁹ (2) determine treatment effectiveness; (3) define the project-specific performance indicator CECs and surrogates to monitor during the baseline phase; and (4) specify the expected removal percentages for performance indicator CECs and surrogates. The monitoring requirements for the initial assessment monitoring phase shall apply to the start-up of new facilities, piloting of new unit processes at existing facilities, and existing facilities where CECs and surrogates have not been assessed equivalent to the requirements of this Policy. Data from prior assessment need not replicate the exact frequency and duration of the initial assessment phase requirements specified in Table 3, if the overall robustness and size of the data are sufficient to adequately characterize the CECs, surrogates, and treatment performance. The initial assessment monitoring phase shall be conducted for a period of one year.

During the initial assessment monitoring phase for the applicable recycled water application method, each of the health-based CECs and performance indicator CECs

⁹ The identification of the occurrence of health-based CECs, performance indicator CECs, and surrogates in groundwater only applies to groundwater recharge reuse by surface application.

listed in Table 1 and appropriate surrogates (see Section 1.2) shall be monitored. Surrogates shall be selected to monitor individual unit processes or combinations of unit processes that remove CECs. Performance indicator CEC and surrogate monitoring results that demonstrate measurable removal for a given unit process shall be candidates for use in the monitoring programs for the baseline and standard operation phases. Monitoring requirements for the initial assessment phase are summarized in Table 3.

For existing groundwater recharge reuse projects, historic monitoring data may be used to assess the occurrence and removal of CECs and surrogates. Existing projects demonstrating prior assessment of CECs and surrogates equivalent to the initial assessment phase requirements of this Policy may skip the initial monitoring phase and initiate the baseline monitoring phase requirements in Section 3.2.

Monitoring results shall be evaluated following each sampling event to allow timely implementation of any response actions. If evaluation of monitoring results indicates a concern, such as finding a concentration of a health-based CEC above the thresholds described in Table 7, more frequent monitoring may be required to further evaluate the effectiveness of the treatment process. Additional actions may also be warranted, which may include, but not be limited to, resampling to confirm a result, additional monitoring, implementation of a source identification program, toxicological studies, engineering removal studies, and/or modification of facility operations. If additional monitoring is required, the Regional Water Board shall consult with CDPH and revise the Monitoring and Reporting Program as appropriate. Evaluation of monitoring results and determination of appropriate response actions based on the monitoring results are presented in Section 4.

Following completion of the initial assessment monitoring phase, monitoring requirements shall be re-evaluated and subsequent requirements for the baseline monitoring phase shall be determined on a project-specific basis.

3.2. Baseline Monitoring Phase

Based on the findings of the initial assessment monitoring phase, project-specific performance indicator CECs and surrogates shall be selected for monitoring during the baseline monitoring phase. The purpose of the baseline monitoring phase is to assess and refine which health-based CECs, performance indicator CECs and surrogates are appropriate to monitor the removal of CECs and treatment system performance for the standard operation of a facility. Performance indicator CECs and surrogates that exhibited reduction by unit processes and/or provided an indication of operational performance shall be selected for monitoring during the baseline monitoring phase. Surrogates not reduced through a unit process are not good indicators of the unit's intended performance. For example, soil aquifer treatment may not effectively lower electrical conductivity. Therefore, electrical conductivity may not be a good surrogate for soil aquifer treatment. The baseline monitoring phase shall be conducted for a period

of three years following the initial assessment monitoring phase. Monitoring requirements for the baseline phase are summarized in Table 4. If a performance indicator CEC listed in Table 1 is found not to be a good indicator, the project proponent shall propose an alternative performance indicator CEC representative of the constituent group to monitor. This performance indicator CEC shall be subject to approval by the Regional Water Board in consultation with CDPH.

For existing groundwater recharge reuse projects, historic monitoring data may be used to assess removal of health-based CECs, performance indicator CECs and surrogates. Existing projects that can demonstrate prior assessment of CECs and surrogates equivalent to the initial assessment phase and baseline phase requirements of this Policy may be eligible for the standard operation monitoring requirements.

Monitoring results shall be evaluated following each sampling event to allow timely implementation of any response actions. If evaluation of monitoring results indicates a concern, such as finding a concentration of a health-based CEC above the thresholds described in Table 7, more frequent monitoring may be required to further evaluate the effectiveness of the treatment process. Additional actions may also be warranted, which may include, but not be limited to, resampling to confirm a result, additional monitoring, implementation of a source identification program, toxicological studies, engineering removal studies, and/or modification of facility operation. If additional monitoring is required, the Regional Water Board shall consult with CDPH and revise the Monitoring and Reporting Program as appropriate. Evaluation of monitoring results and determination of appropriate response actions based on the monitoring results are presented in Section 4.

Following the baseline operation monitoring phase, monitoring requirements shall be re-evaluated and subsequent requirements for the standard operation of a project shall be determined on a project-specific basis.

Table 3: Initial Assessment Phase Monitoring Requirements

<u>Recycled Water Use</u>	<u>Constituent</u>	<u>Frequency</u>	<u>Monitoring Point</u>
Groundwater Recharge Reuse- Surface Application	<u>Health-Based CECs and Performance Indicator CECs:</u> All listed in Table 1.	Quarterly ¹	- Following tertiary treatment prior to application to surface spreading area. - At monitoring well locations designated in consultation with CDPH. ²
	<u>Surrogates:</u> To be selected on a project-specific basis. ⁵	<u>1st 3 months:</u> To be determined on a project-specific basis. ³	- Following tertiary treatment prior to application to the surface spreading area. - At monitoring well locations designated in consultation with CDPH. ²
		<u>3-12 months:</u> To be determined on a project-specific basis. ³	- Following tertiary treatment prior to application to the surface spreading area. - At monitoring well locations designated in consultation with CDPH. ²
Groundwater Recharge Reuse -Subsurface Application	<u>Health-Based CECs:</u> All listed in Table 1.	Quarterly ¹	Following treatment prior to release to the aquifer.
	<u>Performance Indicator CECs:</u> All listed in Table 1.	Quarterly ¹	- Prior to RO treatment. ⁴ - Following treatment prior to release to the aquifer.
	<u>Surrogates:</u> To be selected on a project-specific basis. ⁵	To be determined on a project-specific basis.	- At locations approved by the Regional Water Board. ⁶

1 – This is the initial monitoring frequency for the monitoring and reporting program. The Regional Water Board may require additional monitoring to respond to a concern as stated in Section 3.1.

2 – Groundwater within the distance groundwater travels downgradient from the application site in 30-days.

3 – The monitoring frequency shall be determined by the Regional Water Board in consultation with CDPH. The intent is to have an increased monitoring frequency during the first three months and a decreased monitoring frequency after three months.

4 – If the project proponent can demonstrate that the RO unit will not substantially remove a CEC, the Regional Water Board may allow monitoring for that CEC prior to the AOP, instead of prior to the RO unit.

5 – See Section 1.2 for guidance on selection of surrogates.

6 – See Section 2.2.2 for information on surrogate monitoring locations for subsurface application.

Table 4: Baseline Phase Monitoring Requirements

<u>Recycled Water Use</u>	<u>Constituent</u>	<u>Frequency</u>	<u>Monitoring Point</u>
Groundwater Recharge Reuse – Surface Application	<u>Health-Based CECs:</u> All listed in Table 1. <u>Performance Indicator CECs:</u> Selected based on the findings of the initial assessment phase.	Semi-Annually ¹	- Following tertiary treatment prior to application to the surface spreading area. - At monitoring well locations designated in consultation with CDPH. ²
	<u>Surrogates:</u> Selected based on the findings of the initial assessment phase.	Based on findings of the initial assessment phase.	- Following tertiary treatment prior to application to the surface spreading area. - At monitoring well locations designated in consultation with CDPH. ²
Groundwater Recharge Reuse – Subsurface Application	<u>Health-Based CECs:</u> All listed in Table 1.	Semi-Annually ¹	Following treatment prior to release to the aquifer.
	<u>Performance Indicator CECs:</u> Selected based on the findings of the initial assessment phase.	Semi-Annually ¹	- Prior to RO treatment. ³ - Following treatment prior to release to the aquifer.
	<u>Surrogates:</u> Selected based on the findings of the initial assessment phase.	Based on findings of the initial assessment phase.	- At locations approved by the Regional Water Board. ⁴

1 – More frequent monitoring may be required to respond to a concern as stated in Section 3.2.

2 – Groundwater within the distance groundwater travels downgradient from the application site in 30-days.

3 – If the project proponent can demonstrate that the RO unit will not substantially remove a CEC, the Regional Water Board may allow monitoring for that CEC prior to the AOP, instead of prior to the RO unit.

4 – See Section 2.2.2 for information on surrogate monitoring locations for subsurface application.

3.3. Standard Operation Monitoring

Based on the findings of the baseline monitoring phase, monitoring requirements for health-based CECs, performance indicator CECs and surrogates may be refined to establish project-specific requirements for monitoring the standard operating conditions of a groundwater recharge reuse project. Monitoring requirements for the standard operation phase are summarized in Table 5. The list of health-based CECs may be revised to remove a health-based CEC from the list if monitoring results meet the conditions of the minimum threshold level presented in Table 7. Performance indicator CECs and surrogates that exhibited reduction by a unit process and/or provided an indication of operational performance shall be selected for monitoring of standard operations. If a performance indicator CEC is found to be a poor indicator, the project proponent shall propose an alternative performance indicator CEC representative of the constituent group to monitor. This performance indicator CEC shall be subject to approval by the Regional Water Board in consultation with CDPH.

Monitoring locations for the standard operation phase shall be the same as the locations used for the baseline monitoring phase.

Monitoring for health-based CECs and performance indicator CECs shall be conducted on a semi-annual basis, unless the project demonstrates consistency in treatment effectiveness in removal of CECs, treatment operational performance, and appropriate recycled water quality. These projects may be monitored for CECs on an annual basis. Monitoring frequencies for CECs and surrogates for standard operation monitoring are presented in Table 5.

Monitoring results shall be evaluated following each sampling event to allow timely implementation of any response actions. If evaluation of monitoring results indicates a concern, such as finding a health-based CEC above the thresholds described in Table 7 or a decline in removal of a performance indicator CEC from the performance levels established during the initial and baseline monitoring phases, more frequent monitoring may be required to further evaluate the effectiveness of the treatment process. Additional actions may also be warranted, which may include, but not be limited to, resampling to confirm a result, additional monitoring, implementation of a source identification program, toxicological studies, engineering removal studies, and/or modification of facility operation. If additional monitoring is required, the Regional Water Board shall consult with CDPH and revise the Monitoring and Reporting Program as appropriate. Evaluation of monitoring results and determination of appropriate response actions based on the monitoring results are presented in Section 4.

Table 5: Standard Operation Monitoring Requirement

<u>Recycled Water Use</u>	<u>Constituent</u>	<u>Frequency</u>	<u>Monitoring Point</u>
Groundwater Recharge Reuse - Surface Application	<u>Health-Based CECs:</u> Selected based on the findings of the baseline phase.	Semi-Annually or Annually ¹	- Following tertiary treatment prior to application to the surface spreading area.
	<u>Performance Indicator CECs:</u> Selected based on the findings of the baseline phase.		- At monitoring well locations designated in consultation with CDPH. ²
	<u>Surrogates:</u> Selected based on the findings of the baseline phase.	Based on findings of the baseline assessment phase.	- Following tertiary treatment prior to application to the surface spreading area. - At monitoring well locations designated in consultation with CDPH. ²
Groundwater Recharge Reuse - Subsurface Application	<u>Health-Based CECs:</u> Selected based on the findings of the baseline phase	Semi-Annually or Annually ¹	-Following RO/AOPs treatment prior to release to the aquifer.
	<u>Performance Indicator CECs:</u> Selected based on the findings of the baseline phase.	Semi-Annually or Annually ¹	- Prior to RO treatment. ³ - Following treatment prior to release to the aquifer.
	<u>Surrogates:</u> Selected based on the findings of the baseline phase,	Based on findings of the baseline assessment phase.	At locations approved by the Regional Water Board. ⁴

1 – More frequent monitoring may be required to respond to a concern as stated in Section 3.3.

2 – Groundwater within the distance groundwater travels downgradient from the application site in 30-days.

3 – If the project proponent can demonstrate that the RO unit will not substantially remove a CEC, the Regional Water Board may allow monitoring for that CEC prior to the AOP, instead of prior to the RO unit.

4 – See Section 2.2.2 for information on surrogate monitoring locations for subsurface application.

4. EVALUATION OF CEC AND SURROGATE MONITORING RESULTS

This section presents the approaches for evaluating treatment process performance and health-based CEC monitoring results. Monitoring results for performance indicator CECs and surrogates shall be used to evaluate the operational performance of a treatment process and the effectiveness of a treatment process in removing CECs. For evaluation of health-based CEC monitoring results, a multi-tiered approach of thresholds and corresponding response actions is presented in Section 4.2. The evaluation of monitoring results shall be included in monitoring reports submitted to the Regional Water Board and CDPH.

4.1 Evaluation of Performance Indicator CEC and Surrogate Results

The effectiveness of a treatment process to remove CECs shall be evaluated by determining the removal percentages for performance indicator CECs and surrogates. The removal percentage is the difference in the concentration of a compound in recycled water prior to and after a treatment process (e.g., soil aquifer treatment or RO followed by AOPs), divided by the concentration prior to the treatment process and multiplied by 100.

$$\text{Removal Percentage} = ([X_{\text{in}} - X_{\text{out}}]/X_{\text{in}}) (100)$$

X_{in} - Concentration in recycled water prior to a treatment process

X_{out} - Concentration in recycled water after a treatment process

During the initial assessment, the recycled water project proponent shall monitor performance to determine removal percentages for performance indicator CECs and surrogates. The removal percentages shall be confirmed during the baseline monitoring phase. One example of removal percentages from Drews et. al. (2008) for each application scenario and their associated processes (i.e. soil aquifer treatment or RO/AOPs) is presented in Table 6. The established removal percentages for each project shall be used to evaluate treatment effectiveness and operational performance.

4.1.1. Groundwater Recharge Reuse – Surface Application

For groundwater recharge reuse by surface application, the removal percentage shall be determined by comparing the quality of the recycled water applied to a surface spreading area to the quality of groundwater at monitoring wells. The distance between the application site and the monitoring wells shall be no more than the distance the groundwater travels in 30 days downgradient from the application site. The location of the monitoring wells shall be designated in consultation with CDPH. The removal percentage shall be adjusted to account for dilution from potable water applied to the application site, storm water applied to the application site, and native groundwater.

The removal percentage shall also be adjusted to account for CECs in these waters. The project proponent shall submit a proposal to the Regional Water Board and CDPH as part of its operation plan on how it will perform this accounting.

4.1.2. Groundwater Recharge Reuse – Subsurface Application

For groundwater recharge reuse using subsurface application, the removal percentage shall be determined by comparing recycled water quality before treatment by RO/AOPs and after treatment prior to release to the aquifer.

Table 6: Monitoring Trigger Levels and Removal Percentages

<u>Constituent/ Parameter</u>	<u>Relevance/Indicator Type/Surrogate</u>	<u>Monitoring Trigger Level (micrograms/liter)¹</u>	<u>Removal Percentages (%)²</u>
GROUNDWATER RECHARGE REUSE - SURFACE APPLICATION³			
17β-estradiol	Health	0.0009	-- ⁴
Caffeine	Health & Performance	0.35	>90
NDMA	Health	0.01	--
Triclosan	Health	0.35	--
Gemfibrozil	Performance	--	>90
Iopromide	Performance	--	>90
DEET	Performance	--	>90
Sucralose	Performance	--	<25 ⁵
Ammonia	Surrogate	--	>90
TOC	Surrogate	--	>30
Nitrate	Surrogate	--	>30
UV Absorption	Surrogate	--	>30
GROUNDWATER RECHARGE REUSE - SUBSURFACE APPLICATION⁶			
17β-estradiol	Health	0.0009	--
Caffeine	Health & Performance	0.35	>90
NDMA	Health & Performance	0.01	25-50, >80 ⁷
Triclosan	Health	0.35	--
DEET	Performance	--	>90
Sucralose	Performance	--	>90
Electrical Conductivity	Surrogate	--	>90
TOC	Surrogate	--	>90

1 – Monitoring trigger levels for groundwater recharge reuse and landscape irrigation applications were established in *Monitoring Strategies for Chemicals of Emerging Concern (CECs) in Recycled Water – Recommendations of a Science Advisory Panel*, dated June 25, 2010.

2 –The removal percentages presented in this table are from work by Drewes et.al. (2008) and provide an example of performance for that specific research. Project specific removal percentages will be developed for each groundwater recharge reuse project during the initial and baseline monitoring phases.

3 – Treatment process: Soil aquifer treatment. The stated removal percentages are examples and need to be finalized during the initial and baseline monitoring phases for a given site.

4 – Not applicable

5 – Sucralose degrades poorly during soil aquifer treatment. It is included here mainly as a tracer.

6 – Treatment process: Reverse osmosis and advanced oxidation process.

7 – For treatment using reverse osmosis, removal percentage is between 25 and 50 percent. For treatment using reverse osmosis and advanced oxidation processes, removal percentage is greater than 80 percent.

4.2. Evaluation of Health-Based CEC Results

The project proponent shall evaluate health-based CEC monitoring results. To determine the appropriate response actions, the project proponent shall compare measured environmental concentrations (MECs) to their respective monitoring trigger levels¹⁰ (MTLs) listed in Table 6 to determine MEC/MTL ratios. The project proponent shall compare the calculated MEC/MTL ratios to the thresholds presented in Table 7 and shall implement the response actions corresponding to the threshold.

For surface application, the results shall be evaluated for groundwater collected from the monitoring wells. For subsurface application projects, results shall be evaluated for the recycled water released to the aquifer.

Table 7: MEC/MTL Thresholds and Response Actions

MC/MTL Threshold	Response Action
If greater than 75 percent of the MEC/MTL ratio results for a CEC are less than or equal to 0.1 during the baseline monitoring phase and/or subsequent monitoring -	A) After completion of the baseline monitoring phase, consider requesting removal of the CEC from the monitoring program.
If MEC/MTL ratio is greater than 0.1 and less than or equal to 1 -	B) Continue to monitor.
If MEC/MTL ratio is greater than 1 and less than or equal to 10 -	C) Check the data. Continue to monitor.
If MEC/MLT ratio is greater than 10 and less than or equal to 100 -	D) Resample immediately and analyze to confirm CEC result. Continue to monitor.
If MEC/MLT ratio is greater than 100 -	E) Resample immediately and analyze to confirm result. Continue to monitor. Contact the Regional Water Board and CDPH to discuss additional actions. (Additional actions may include, but are not limited to, additional monitoring, toxicological studies, engineering removal studies, modification of facility operation, implementation of a source identification program, and monitoring at additional locations.)

¹⁰ Monitoring Trigger Level (MTL): Health-based screening level value for a CEC for a particular water reuse scenario. MTLs were established in, *Monitoring Strategies for Chemicals of Emerging Concern (CECs) in Recycled Water – Recommendations of a Science Advisory Panel*, dated June 25, 2010.

STATE WATER RESOURCES CONTROL BOARD
WATER QUALITY ORDER NO. 2009-0006-DWQ

GENERAL WASTE DISCHARGE REQUIREMENTS FOR
LANDSCAPE IRRIGATION USES OF MUNICIPAL RECYCLED WATER
(GENERAL PERMIT)

The State Water Resources Control Board (State Water Board) finds that:

1. The California Legislature has declared its intent to promote the use of recycled water. Recycled water^{1,2} is a valuable resource and significant component of California's water supply. When used in compliance with the Recycled Water Policy,³ California Code of Regulations (CCR) Title 22, and all applicable state and federal water quality laws, the State Water Board finds that recycled water is safe for approved uses, and strongly supports recycled water as a safe alternative to potable water for such approved uses.
2. This General Permit is intended to satisfy the requirements of California Water Code (Water Code) section 13552.5 and is for Producers and Distributors⁴ of recycled water for landscape irrigation uses. This General Permit is intended to streamline the regulatory process for such uses of recycled water but may not be appropriate for all scenarios due to unique site-specific characteristics and conditions. For this General Permit, "recycled water" is limited to disinfected tertiary recycled water produced by a public entity at a municipal wastewater treatment plant (WWTP), as defined in Water Code section 13625(b)(1) and section 13625(b)(2). This General Permit is not applicable for the use of water produced from the treatment of other non-municipal wastewaters (e.g., oil field production, food processing, storm water, etc.) at other types of treatment facilities (e.g., industrial wastewater treatment plants). Pursuant to Water Code section 13552.5(e)(1), persons who are covered under this General Permit are not required to remain subject to the applicable provisions of existing waste discharge requirements or water reclamation requirements.
3. Landscape irrigation with recycled water is a viable strategy to reduce potable water demand and to reduce the volume of water wasted after a single use. Specified uses of recycled water considered "landscape irrigation" projects include any of the following:
 - i. Parks, greenbelts, and playgrounds;
 - ii. School yards;
 - iii. Athletic fields;
 - iv. Golf courses;
 - v. Cemeteries;

¹ *Recycled Water*. Water which, as a result of treatment of municipal wastewater, is suitable for a direct beneficial use or a controlled use that would not otherwise occur and is therefore considered a valuable resource (Water Code section 13050).

² The terms "recycled water" and "reclaimed water" have the same meaning (Water Code section 26).

³ The Recycled Water Policy was adopted on February 3, 2009 under State Water Board Resolution No. 2009-0011.

⁴ Throughout this General Permit, refer to Attachment A for definitions.

- vi. Residential landscaping, common areas;⁵
 - vii. Commercial landscaping, except eating areas;
 - viii. Industrial landscaping, except eating areas; and
 - ix. Freeway, highway, and street landscaping.
4. Recycled water projects eligible for coverage under this General Permit shall meet the following treatment and use standards:
 - a. The Producer shall, being a public entity, produce disinfected tertiary recycled water, as defined in CCR Title 22, sections 60301.230 and 60301.320, at a municipal wastewater treatment plant; and
 - b. The Distributors shall comply with the applicable uniform statewide reclamation criteria established pursuant to CWC section 13521 (i.e., CCR Title 22 section 60301 et. seq., hereafter "Title 22 Requirements").
 - c. The Producer and Distributor shall ensure that Users comply with the applicable uniform statewide reclamation criteria established pursuant to Title 22 Requirements.
 - d. The Producers and Distributor shall satisfy all applicable requirements of the Recycled Water Policy.
5. The use of recycled water for landscape irrigation has characteristics which can create water quality and public health problems if improperly treated and managed. It is necessary to establish requirements for landscape irrigation uses of recycled water that ensure protection of water resources and public health. (e.g., pathogenic organisms, salinity and other waste constituents, and potential for unauthorized discharges).
6. This General Permit establishes requirements to manage recycled water for landscape irrigation uses in a manner that is protective of public health and the environment. The State Water Board will exercise its authority to the fullest extent possible to encourage the use of recycled water, consistent with state and federal water quality laws. The beneficial use of recycled water for landscape irrigation under this General Permit is environmentally sound and preferable to non-beneficial disposal and waste of water. This General Permit builds on extensive work that has already been done by the Water Boards, the California Department of Public Health (CDPH), the 2003 Recycled Water Task Force and many others.
7. This General Permit is applicable to Use Areas where recycled water is used or conveyed for landscape irrigation and is not intended to regulate the treatment of municipal wastewater. Compliance with this General Permit does not relieve Producers or Distributors from the obligation to comply with applicable waste discharge requirements for discharges from wastewater treatment plants other than landscape irrigation uses of recycled water authorized pursuant to this General Permit.

⁵ Individually owned residences are not eligible for coverage under this General Permit. The Regional Water Boards will address individually owned residences on a case-by-case basis.

8. To obtain coverage under this General Permit, either a Producer or a Distributor shall submit a complete Notice of Intent (NOI) form (Attachment B), Operations & Maintenance Plan, and appropriate application fee to the State Water Board. Either a Producer or a Distributor shall declare responsibility for the administration of the recycled water program authorized pursuant to this General Permit (hereafter Administrator). A duly authorized representative for each entity involved in the production and distribution of recycled water shall each sign the NOI form as appropriate. The Producer and Distributor may be the same entity. Administrators who submit a complete application package, meet the eligibility criteria of this General Permit, and following the conclusion of a thirty (30) day public review period, will typically be authorized to distribute recycled water for landscape irrigation uses.
9. The application fee shall be equal to the annual fee, pursuant to Water Code section 13260. Fee amounts are specified in Section 2200, Chapter 9, Division 3, Title 23, CCR. The Administrator shall be billed for an annual fee equal to the application fee until coverage under the General Permit has been terminated.
10. The Regional Water Quality Control Boards (Regional Water Boards) have evaluated groundwater and surface waters within their jurisdictions for their maximum potential beneficial uses.⁶ Some of those use categories are identified in Attachment A. Beneficial uses for specific water bodies can be found in the applicable Water Quality Control Plan (Basin Plan) where the recycled water is used. Basin plans establish water quality objectives to protect the specific designated beneficial uses that may include numerical objectives and / or narrative objectives for chemical constituents in and toxicity of groundwater. Basin Plans establish procedures to quantify the maximum permissible concentrations of constituents for groundwaters designated as municipal, agricultural, and other beneficial uses.

PATHOGENIC ORGANISMS

11. To protect public health, this General Permit employs a minimum treatment standard of disinfected tertiary recycled water, as well as exposure control measures including minimum setback distances, signage, method of application, and use restrictions.
12. To protect public health from risks associated with potential cross-connection and subsequent contamination of potable water systems, California Health and Safety Code (HSC) section 116555 requires that a public water system shall ensure that the system will not be subject to backflow under normal operating conditions. HSC Section 116800 et. seq. authorizes local health officers to maintain a program for the control of cross-connections by water users where public exposure to drinking water contaminated by backflow may occur. Cross-connection programs shall be

⁶ Water Code section 13050(f)

conducted in accordance with backflow prevention regulations adopted by CDPH and may require water users to comply with all orders, instructions, regulations, and notices from the local health officer with respect to the installation, testing, and maintenance of backflow prevention devices.

SALINITY & NUTRIENTS

13. The source of salts and nutrients is attributed to water soluble inorganic and organic constituents in imported water, soil leached by irrigation, animal wastes, fertilizers and other soil amendments, municipal use, industrial wastewaters, and oil field wastewaters. These salt sources, all contributors to salinity increases, should be managed in a manner consistent with the Recycled Water Policy, specifically paragraphs 6 and 9(d).
14. Several approaches can be used to manage concerns over salt accumulations in groundwater. In the absence of treatment or a plan to remove accumulated salinity, another viable approach is to manage the rate of degradation by minimizing the salt loads to the groundwater basin. Salinity loads contributed by the reuse of municipal wastewater can be reduced by either precluding anthropogenic derived salts from introduction into the wastewater collection systems (e.g., source control or pretreatment of wastes) or treatment of salts at the wastewater plant (i.e., removal of salts), or both. Another viable option is a salt/nutrient management plan for a groundwater basin. The State Water Board has addressed the topic of salt management, as it concerns recycled water, in the Recycled Water Policy.
15. The agricultural beneficial use of groundwater tends to be the most vulnerable beneficial use to salinity accumulation. This loss of the agricultural beneficial use is not immediate. Control of salinity accumulation is a major part of several Basin Plans, and will be the topic of the salt/nutrient management plans required by the Recycled Water Policy. In general, salt loads reaching a groundwater body must be reduced. Storage of salt in the soil through increased irrigation efficiency is a good practice, but is not a permanent solution.
16. In Water Quality Order No. 2000-07,⁷ the State Water Board determined that a Producer cannot shift responsibility for discharged salt to the User. This General Permit requires the Producer to produce recycled water that meets the quality standards of this General Permit and associated waste discharge requirement order(s) for the wastewater treatment plant(s).
17. In the absence of detailed hydrological data, it is the responsibility of both the project proponent and the California Water Boards to exercise sound and reasoned judgment in evaluating the case-specific effects of proposed projects and the available factual data for each project. This General Permit attempts to accomplish the balancing of factors necessary to evaluate most projects in the absence of case-specific information. In doing so, this General Permit also establishes a basic

⁷ San Luis Obispo Golf & Country Club, Central Coast Region, State Board WQO No. 2000-07, p 10-12

regulatory strategy to manage the salinity of most recycled water used for landscape irrigation. If, after review of the available factual data, the Executive Director determines that the case-specific effects of a proposed project are inconsistent with the requirements of this General Permit and the Recycled Water Policy (i.e., “unusual circumstances” as used in the Recycled Water Policy), the project is not eligible for coverage under this General Permit.

CHLORINE

18. Some Producers and Distributors chlorinate recycled water delivered and stored for reuse to prevent regrowth of pathogens and growth of organisms that could cause odor nuisance and operational difficulties in the reclamation system. Chlorine is toxic to fish and other aquatic life even at low concentrations.

EMERGING CONSTITUENTS/CHEMICALS OF EMERGING CONCERN (CECs)

19. A need exists to increase understanding of CECs that may be present in recycled water used for landscape irrigation. The many evolving issues associated with “emerging contaminants” are presently the subject of a number of studies, including a major study being undertaken by the National Water Research Institute, the Metropolitan Water District of Southern California, and the Orange County Water District (hereafter Study), estimated to be completed in 2009.
20. Many water supply agencies, at their own expense, are developing and implementing voluntary studies based on the best available science intended to better characterize the presence, extent, distribution and persistence of certain unregulated constituents in water supplies. The State Water Board supports these voluntary efforts.
21. As required by the Recycled Water Policy, the State Water Board is convening a CEC advisory panel to provide recommendations on CEC monitoring and other topics. The State Water Board has consulted with CDPH, the primary state agency responsible for the protection of public health and the regulation of drinking water standards, in convening the CEC advisory panel. In accordance with the Recycled Water Policy, this General Permit does not specify CEC monitoring requirements. After the State Water Board takes action on the recommendations of the CEC advisory panel, this General Permit will be reviewed for any needed revisions.
22. The constituents that are the subject of studies subject to the scrutiny of CDPH, the United States Environmental Protection Agency, and the United States Geological Survey, will in all likelihood change over time as their relative importance or unimportance to human health and the environment becomes better known.

UNAUTHORIZED DISCHARGES OF RECYCLED WATER

23. At some Use Areas, recycled water is discharged into landscape irrigation storage ponds (hereafter “impoundments”) that function as storage for irrigation and may also serve an aesthetic purpose. Some impoundments were originally designed and constructed to collect storm water runoff from surrounding areas and allowed to overflow excess water into nearby drainage ways and creeks. Recycled water used for irrigation of golf courses, parks, or other open spaces and landscaped areas may occur in areas containing numerous hills and sloped areas that could promote runoff unless closely managed during irrigation. In some cases, various chemicals (e.g., copper sulfate, acrolein, etc.) may be added to impoundments for weed, algae, and vector control.
24. When Best Management Practices (BMPs) are implemented, conditions causing runoff, ponding, and windblown spray (drift) are minimized to a negligible amount, and in some cases, eliminated. Attachment C of this General Permit includes a list of BMPs, including specific requirements of the Recycled Water Policy.
25. The control of incidental runoff and compliance with regulatory instruments, including National Pollutant Discharge Elimination System (NPDES) permits, is addressed in paragraph 7(a) of the Recycled Water Policy. This General Permit is in conformance with these requirements.

MASTER RECLAMATION PERMITS

26. CWC section 13523.1 authorizes each Regional Water Board, after consulting with CDPH, to issue a master reclamation permit to a Producer or Distributor, or both, of recycled water, in lieu of issuing waste discharge requirements or water recycling requirements.
27. In some cases, especially for municipal wastewater discharges via an ocean outfall, the NPDES permit for the Producer’s facility does not include requirements necessary to ensure the protection of beneficial uses of groundwater resources (e.g., agricultural supply, municipal supply). In order to facilitate the use of recycled water, Regional Water Boards adopt master reclamation permits that implement the Title 22 Requirements and consider potential impacts to the beneficial uses of groundwater. Thereby, some master reclamation permits prescribe discharge limitations necessary to ensure the protection of beneficial uses of groundwater resources not otherwise included in a Producer’s NPDES permit.
28. A benefit of master reclamation permits is that individual recycled water users are not required to seek individual authorization from a regional water board, thereby avoiding additional regulatory burdens and costs. Administrators that operate pursuant to a master reclamation permit shall be allowed to retain coverage under the master reclamation permit. Alternatively, an Administrator may request coverage under this General Permit.

REGULATORY CONSIDERATIONS

29. The discharges authorized by this General Permit are limited to the discharge of disinfected tertiary recycled water (as defined CCR Title 22, sections 60301.230 and 60301.320) produced by a public entity at a municipal wastewater treatment plant. Such wastewater treatment plants will generally maintain the same or similar wastewater treatment operations, involve the treatment of the same or similar types of waste, and require the same or similar treatment standards.

30. Water Code Section 13267(b)(1) states the following:

In conducting an investigation specified in subdivision (a), the regional board may require that any person who has discharged, discharges, or is suspected of having discharged or discharging, or who proposes to discharge waste within its region, or any citizen or domiciliary, or political agency or entity of this state who has discharged, discharges, or is suspected of having discharged or discharging, or who proposes to discharge, waste outside its region that could affect the quality of waters within its region shall furnish, under penalty of perjury, technical or monitoring program reports which the regional board requires. The burden, including costs, of these reports shall bear a reasonable relationship to the need for the report and the benefits to be obtained from the reports. In requiring those reports, the regional board shall provide the person with a written explanation with regard to the need for the reports, and shall identify the evidence that supports requiring that person to provide the reports

31. Water Code Section 13267(c), in part, states the following:

In conducting an investigation pursuant to subdivision (a), the regional board may inspect the facilities of any person to ascertain whether the purposes of this division are being met and waste discharge requirements are being complied with.

32. Water Code Section 13267(f) states the following:

The state board may carry out the authority granted to a regional board pursuant to [Water Code section 13267] if, after consulting with the regional board, the state board determines that it will not duplicate the efforts of the regional board.

33. The information required by this General Permit is necessary to determine compliance with this General Permit and to ensure compliance with the Water Code and the Title 22 Requirements. Improper use or discharge of recycled water represents a threat to the quality of waters of the state and to human health and the environment. A completed NOI form identifies the entities responsible for ensuring proper production, distribution, and/or use of recycled water in accordance with this General Permit.

34. The information required by this General Permit will not duplicate the efforts of the regional board.
35. In 1977, the State Water Board adopted Resolution No. 77-1, titled “Policy with Respect to Water Reclamation in California” (Resolution No. 77-1). Resolution No. 77-1, in part, encourages the use of recycled water in the state.
36. A 1996 Memorandum of Agreement (MOA) between CDPH and the State Water Board on behalf of itself and the Regional Water Boards regarding the use of recycled water allocates primary areas of responsibility and authority between these agencies. The MOA provides methods and mechanisms necessary to ensure ongoing and continuous future coordination of activities relative to the use of recycled water in California. This General Permit includes requirements consistent with the MOA.
37. In 1968, the State Water Board adopted Resolution No. 68-16 (hereafter the “Antidegradation Policy”) which requires that the authorization to discharge waste maintain high quality waters of the State until it is demonstrated that any change in quality is consistent with maximum benefit to the people of the State, will not unreasonably affect beneficial uses, and will not result in water quality less than that described in water quality policies (i.e., will not result in exceedances of water quality objectives).
38. Degradation of groundwater by constituents in recycled water after effective source control, treatment, and control may be determined consistent with maximum benefit to the people of California. This determination is based on considerations of reasonableness under the circumstances of the recycled water use. Factors to be considered include:
 - a. Past, present, and probable beneficial uses of the receiving water (as specified in the applicable basin plan;
 - b. Economic and social costs, tangible and intangible, of the recycled water usage compared to the benefits;
 - c. Environmental aspects of the recycled water usage; and
 - d. Implementation of feasible alternative treatment or control methods.
39. This General Permit establishes terms and conditions of discharge to ensure that the discharge does not unreasonably affect present and anticipated beneficial uses of groundwater and surface water for the following reasons:
 - a. Recycled water will be applied at agronomic rates reflecting the seasonal hydraulic and nutrient requirements of the Use Area;
 - b. The Producer is responsible for ensuring that recycled water meets the quality standards of the General Permit and associated waste discharge requirement order(s) for the municipal WWTP(s); and
 - c. Discharge to surface waters, unless otherwise authorized by an NPDES permit, is prohibited.

40. Degradation of groundwater by some of the typical waste constituents released with discharges from a municipal WWTP after effective source control, treatment, and use control is consistent with maximum benefit to the people of the State. Economic prosperity of State communities and associated industries is of maximum benefit to the people of the State, and therefore sufficient reason to allow limited groundwater degradation, provided that terms of the applicable Water Quality Control Plan and the Recycled Water Policy are met.
41. To comply with this General Permit, Producers and Distributors, must implement (and ensure Users implement) the following treatment and control measures necessary to avoid pollution or nuisance and maintain the highest water quality consistent with the maximum benefit to the people of the state:
 - a. Implement treatment and use standards necessary to produce disinfected tertiary recycled water and implement the applicable Title 22 Requirements;
 - b. Apply recycled water at agronomic rates;
 - c. Identify and implement best management practices;
 - d. Develop, maintain, and implement an Operation & Maintenance Plan; and
 - e. Employ trained personnel (e.g., Recycled Water Use Supervisor)

CALIFORNIA ENVIRONMENTAL QUALITY ACT

42. To mitigate or avoid environmental effects on water quality, this General Permit:
 - a. Requires application of recycled water at reasonable agronomic rates considering soil, climate, and nutrient demand;
 - b. Requires areas irrigated with recycled water be managed to prevent nuisance conditions or breeding of mosquitoes; and
 - c. Establishes a Monitoring and Reporting Program, which includes inspections and regular maintenance of areas irrigated with recycled water.
43. On July 7, 2009, in accordance with California Environmental Quality Act (CEQA),⁸ the State Water Board, acting as the lead agency, adopted Resolution No. 2009-0059 which certified a Mitigated Negative Declaration for this project and determined that the project would have no significant effect on the environment.
44. The State Water Board has notified all known interested agencies and persons of its intent to prescribe general waste discharge requirements for landscape irrigation uses of recycled water and has provided all known interested agencies and persons with an opportunity for a public hearing and an opportunity to submit comments.
45. The State Water Board has consulted with and considered comments from the regional water quality control boards, groundwater management agencies and water replenishment districts with statutory authority to manage groundwater pursuant to their principal act, CDPH, and other interested parties.

⁸ Public Resources Code, Section 21000, et seq.

46. The State Water Board, in a public meeting on July 7, 2009, heard and considered all comments pertaining to this General Permit.

IT IS HEREBY ORDERED that all Producers and Distributors of recycled water, or combinations thereof, that file a complete application package declaring their intention to be regulated under provisions of this General Permit, in order to meet the provisions contained in Division 7 of the Water Code and regulations adopted thereunder, shall comply with the following:

A. PROHIBITIONS

1. The use of recycled water pursuant to this General Permit is prohibited unless the Administrator has submitted a complete Notice of Intent (NOI) form, Operation & Maintenance Plan, and application fee and has received confirmation of enrollment under this General Permit.
2. The use of recycled water in a manner different than described in the Operation & Maintenance Plan is prohibited.
3. The use of recycled water, pursuant to this General Permit, for individually owned residences other than as described in Finding No. 3 is prohibited.
4. In conformance with Title 22 Requirements, recycled water shall not be used for direct human consumption or for the processing of food or drink intended for human consumption.
5. The use of recycled water for uses other than landscape irrigation uses is prohibited.
6. The use of recycled water on water-saturated or frozen ground or during periods of precipitation such that runoff is induced, is prohibited.
7. The direct or indirect discharge from use areas of recycled water to surface waters, either perennial or ephemeral, including wetlands, vernal pools, etc. is prohibited, unless otherwise authorized by an NPDES permit.
8. The application of recycled water within fifty (50) feet of a domestic well, and impoundment of recycled water within one hundred (100) feet of a domestic well, unless approved by CDPH, is prohibited.
9. Use or installation of hose bibbs in areas accessible by the public on any irrigation system presently operating or designed to operate with recycled water, regardless of construction or identification, is prohibited.
10. Use of any equipment or facilities that have been used to convey recycled water (e.g., tanks, temporary piping or valves, and portable pumps) also used for potable water supply conveyance, is prohibited.

11. The discharge or use of recycled water in a manner that causes or contributes to an exceedance of an applicable water quality objective is prohibited.
12. The use of recycled water for landscape irrigation shall not cause or threaten to cause pollution or nuisance as defined in Water Code section 13050.

B. SPECIFICATIONS

1. Recycled water shall be managed in conformance with the applicable regulations contained in the Title 22 Requirements.
2. All recycled water provided to Users pursuant to this General Permit, shall be treated in and managed in conformance with all applicable provisions of the Recycled Water Policy.

Disinfected Tertiary Recycled Water Criteria

3. The Producer or Distributor shall collectively provide all Users disinfected tertiary recycled water that meets the standards for *disinfected tertiary recycled water* as described in CCR Title 22, sections 60301.230 and 60301.320.

Recycled Water Application

4. Application of recycled water to the Use Area shall be at reasonable agronomic rates and shall consider soil, climate, and nutrient demand. Application rates shall ensure that a nuisance is not created. Degradation of groundwater, considering soil, climate, and nutrient demand, shall be minimized consistent with applicable provisions of the Recycled Water Policy.
5. The seasonal nutritive loading of the Use Area including the nutritive value of organic and chemical fertilizers and of the recycled water, shall not exceed the nutritive demand of the landscape.
6. Use Areas that are spray irrigated and allow public access shall be irrigated during periods of minimal use. Consideration shall be given to allow maximum drying time prior to subsequent public use.

Recycled Water Utilities, Equipment, Signage, and Use Areas

7. All newly installed or any accessible reclamation equipment, pumps, piping, valves, and outlets shall be appropriately marked to differentiate them from potable facilities. All newly installed or any accessible reclamation distribution system piping shall be purple or adequately identified with purple tape, tags, or stickers per Section 116815(a) of the California Health and Safety Code.
8. Except as allowed under Section 7604 of Title 17, California Code of Regulations, no physical connection shall be made or allowed to exist between any recycled water system and any separate system conveying potable water. Supplementing recycled water with potable water shall not be allowed except as approved by CDPH.
9. A 4-foot horizontal and 1-foot vertical separation⁹ shall be maintained between all new pipelines transporting recycled water and those transporting domestic water, unless approved by CDPH. Domestic water pipelines shall be configured above recycled water pipelines, unless approved by CDPH.
10. All recycled water valves, outlets, and quick couplers should be of a type or secured in a manner that only permits operation by authorized personnel.
11. The main shutoff valve of the recycled water meter shall be tagged with a recycled water warning sign. The valve shall be equipped with an appropriate locking device to prevent unauthorized operation of the valve.
12. Except where CDPH has approved alternative signage and wording or an educational program pursuant to Title 22 Requirements, (1) all use areas where recycled water is used that are accessible to the public shall be posted with signs that are visible to the public in a size no less than four inches high by eight inches wide that include the following wording “RECYCLED WATER-DO NOT DRINK”, and (2) each sign shall display an international symbol similar to that shown in Attachment D.
13. Spray, mist, or runoff of recycled water shall not enter dwellings, designated outdoor eating areas, or food handling facilities. Drinking water fountains shall be protected against contact with recycled water spray, mist or runoff.
14. Recycled water shall be managed to minimize contact with workers.
15. Best Management Practices (BMPs) shall be developed and implemented to achieve a safe and efficient irrigation system. At a minimum, the Administrator shall implement and ensure that all other Producers,

⁹ As measured from the nearest outside edge of the respective pipelines.

Distributors, and Users associated with each respective NOI implement the Required BMPs identified in Attachment C (I.A. – I.D.) and consider implementing other BMPs as appropriate.

16. Recycled water shall not be allowed to escape from the Use Area by overspray, mist or by surface flow except in minor amounts such as that associated with BMPs for good irrigation practices.
17. Areas irrigated with recycled water shall be managed to prevent ponding and conditions conducive to the proliferation of mosquitoes and other vectors, and to avoid creation of a public nuisance or health hazard. The following practices shall be implemented, at a minimum:
 - a. Irrigation water must infiltrate completely within a 48-hour period.
 - b. Ditches receiving irrigation runoff, not serving as wildlife habitat, shall be maintained free of emergent, marginal, and floating vegetation.
 - c. Low-pressure and unpressurized pipelines and ditches that may be accessible to mosquitoes shall not be used to store recycled water.
18. The Producer or Distributor shall discontinue delivery of recycled water during any period in which either has reason to believe that the requirements for use as specified herein or the requirements of CDPH are not being met. The delivery of recycled water shall not resume until all conditions have been corrected.

C. PROVISIONS

1. A duly authorized representative for each Producer and Distributor shall each sign the completed NOI form (Attachment B). Enforcement actions for violations of this General Permit may be taken against all responsible entities for violations of any part of this General Permit. However, in general, responsibilities for Producers and Distributors are as follows:
 - a. Producers shall be responsible for ensuring that recycled water meets the quality standards of this General Permit and any associated waste discharge requirement order(s) for the WWTP(s).
 - b. Distributors shall be responsible for the operation and maintenance of transport facilities and associated appurtenances necessary to convey and distribute the recycled water from the point of production to the point of use with all applicable Title 22 requirements.
 - c. The Producer and Distributor shall be responsible for the application and use of recycled water in the respective Use Areas and for associated operations and maintenance in accordance with all applicable Title 22 requirements and this General Permit. The Producer and Distributor are also responsible for ensuring that Users maintain the minimum land application acreage and impoundment

capacity to comply with the terms and conditions of this General Permit.

2. The Administrator shall comply with Monitoring and Reporting Program No. 2009-0006-DWQ and revisions thereto, as specified by the Executive Director.
3. CDPH may identify in its recommendations with respect to the proposed recycled water use any conditions upon which its approval of a proposed project is based. "Conditions of approval" submitted as part of CDPH's recommendations will be incorporated into a Notice of Applicability for the proposed recycled water use project.
4. The Administrator shall require each User to designate a Recycled Water Use Supervisor for each Use Area, respectively. The Recycled Water Use Supervisor shall be responsible for the recycled water system within the Use Area. Specific responsibilities of the Recycled Water Use Supervisor, at a minimum, shall include the following:
 - a. Proper installation, operation and maintenance of irrigation systems;
 - b. Control of on-site piping to prevent any cross-connections with potable water supplies;
 - c. Development of and implementation of a set of procedures to verify on an ongoing basis that cross-connections have not occurred between potable water supplies and recycled water supplies;
 - d. Routine inspection and maintenance of backflow prevention devices installed to protect potable water supplies, consistent with section 7605 of Title 17, California Code of Regulations; and
 - e. General responsibilities to ensure compliance with this General Permit and continuous implementation of any Best Management Practices identified as necessary to prevent potential hazards to public health and to protect the environment.
5. Prior to commencing irrigation with recycled water, the Administrator shall submit an Operations and Maintenance Plan (O&M Plan) to the State Water Board. An O&M Plan shall contain the following elements:
 - a. An Operations Plan. A detailed operations plan for the Use Areas including methods and procedures for implementation of regulations regarding recycled water use and maintenance of equipment and emergency backup systems to maintain compliance with the conditions of this General Permit and CDPH requirements (i.e., identification of BMPs implemented to achieve and maintain compliance).
 - b. An Irrigation Management Plan. The Irrigation Management Plan shall include measures to ensure the use of recycled water occurs at an agronomic rate while employing practices to ensure irrigation

efficiency necessary to minimize application of salinity constituents (by mass) to Recycled Water Use Areas. The Irrigation Management Plan shall be applicable for each Recycled Water Use Area served and shall account for the following:

- i. Soil characteristics;
- ii. Recycled water characteristics (nutrients, including nitrogen and phosphorous content; specific ion toxicity, including chloride, boron, sodium, bicarbonate; and other parameters);
- iii. General requirements of the major plant species being irrigated (e.g., seasonal demand, climate, nutrient requirements);
- iv. Climatic conditions (e.g., precipitation, evapotranspiration rate, wind);
- v. Other supplemental nutrient additions (e.g., chemical fertilizers) generally used within the Use Area; and
- vi. Management of impoundments used to store or collect recycled water.

Where conditions 5.b.i. thru 5.b.vi vary substantially across a service area, the Irrigation Management Plan shall also include sub-basin irrigation management plans that ensure the use of recycled water occurs at an agronomic rate while employing practices to ensure irrigation efficiency necessary to minimize application of salinity constituents (by mass).

- c. A summary of the applicable approved Title 22 Engineering Report submitted to CDPH. The summary of the Title 22 Engineering Report shall address the following:
 - i. Method(s) of wastewater treatment and manner for achieving disinfected tertiary recycled water;
 - ii. Method(s) to be used to assure that the installation and operation of the recycled system will not result in cross-connections between the recycled water and potable water piping systems.
 - iii. Any recommendations or “conditions of approval” provided by CDPH;
 - iv. Copy of any approval letter(s) prepared by CDPH¹⁰.Administrators may provide a copy of the complete approved Title 22 Engineering Report in lieu of a summary. The Title 22 Engineering Report shall be available upon request for review and inspection.
- d. A copy of the Producer’s or Distributor’s established rules and/or regulations as approved by CDPH for Producers, Distributors and Users governing the design and construction of recycled water use facilities and the use of recycled water in accordance with the criteria established in the Title 22 Requirements and this Permit.

¹⁰ Formerly, the California Department of Health Services

- e. A copy of the written (and signed) agreement between the respective parties responsible for the producing, distributing, and using the recycled water.
 - f. Recycled Water Use Supervisor responsibilities and training.
 - i. Documentation of or examples from a training program including periodic education, for Recycled Water Use Supervisors. At a minimum, such training programs shall include the following elements:
 - (1) The safe and efficient operation and maintenance of recycled water use facilities.
 - (2) Prevention of runoff from Recycled Water Use Areas.
 - (3) Matching irrigation rates to the water requirements of the landscape, and not applying when the soil is saturated.¹¹
 - (4) Means for ensuring recycled water and other supplemental nutrients (including fertilizers) are used pursuant to the Irrigation Management Plan (i.e., at agronomic rates¹²)
 - (5) Prevention of cross-connections with potable water systems
 - ii. A copy of an example duty statement for the Recycled Water Use Supervisor responsible for the Use Area.
 - iii. Verification that the Recycled Water Use Supervisor has attended training regarding the safe and efficient operation and maintenance of recycled water use facilities.
6. Producers and Distributors shall maintain and comply with the O&M Plan, and all portions thereof including the Irrigation Management Plan submitted pursuant to this General Permit and the applicable Title 22 Engineering Report.
7. Amendments to the approved Title 22 Engineering Report as well as a description of new use sites shall be submitted to the appropriate public health authority for approval in advance of connection. The Administrator shall include in the annual report submitted to the State Water Board copies of approval letter(s) prepared by CDPH regarding (1) such amendments to the Title 22 Engineering Report and (2) a description of new sites.
8. The Administrator shall ensure that all Users comply with the O&M Plan, and all relevant portions thereof including the Irrigation Management Plan submitted pursuant to this General Permit and the applicable approved Title 22 Engineering Report. To demonstrate compliance with this Provision, the Administrator may develop a pamphlet, brochure, or other educational materials, that convey the key operational elements (e.g., prevention of cross-connections, how to adjust fertilization rates, impoundment management practices, etc.) of the O&M Plan to the Recycled Water Use

¹¹ Accounting for soil saturation conditions

¹² Including accounting for fertilizers

Supervisor. The Administrator shall also ensure compliance with any applicable Salt and Nutrient Management Plans.

9. The Administrator shall ensure that periodic inspections are conducted of the Use Areas they supply at a frequency approved by CDPH (but no less than annually), including an adaptive approach to address Use Areas with a record of compliance concerns. The Administrator shall also establish procedures to monitor and assure compliance with conditions of this General Permit. The Administrator shall also ensure that regular inspections occur to assure cross-connections with potable water systems are not made and air-gap devices are installed and operable.
10. The Producer and Distributor shall keep a copy of the O&M Plan and this General Permit, including its Monitoring and Reporting Program, and attachments in a location where they can be easily referenced by operating personnel. Key operating personnel, including the Recycled Water Use Supervisor, shall be familiar with its contents.
11. The Producer and Distributor shall at all times properly operate and maintain all facilities and systems of treatment and control (and related appurtenances) that are installed to achieve compliance with the conditions of this General Permit.
12. All technical reports required herein that involve planning, investigation, evaluation, or design, or other work requiring interpretation and proper application of engineering or geologic sciences, shall be prepared by or under the direction of persons registered to practice in California pursuant to California Business and Professions Code¹³. To demonstrate compliance with sections 415 and 3065 of Title 16, CCR, all technical reports must contain a statement of the qualifications of the responsible registered professional(s). As required by these laws, completed technical reports must bear the signature(s) and seal(s) of the registered professional(s) in a manner such that all work can be clearly attributed to the professional responsible for the work.
13. All storm water discharges, including conditionally authorized or exempted non-storm water discharges, from recycled water use areas must comply with the lawful requirements of municipalities, counties, drainage districts, and/or other local agencies, regarding discharges of storm water to Municipal Separate Storm Sewer Systems (MS4s) under their jurisdiction.
14. It is the responsibility of the Producer and Distributor to make inquiry and to obtain any local, state, and federal governmental agency permits or authorizations prior to the distribution and use of recycled water for landscape irrigation.

¹³ sections 6735, 7835, and 7835.1

15. Coverage under this General Permit is not transferable. The Administrator shall notify the Executive Director in writing at least thirty (30) days in advance of change in ownership related to the Administrator, other Distributors, or Producers authorized to use recycled water pursuant to this General Permit. The Administrator shall use the Notice of Termination (NOT) form in Attachment E to satisfy this provision.
16. The Administrator shall require Users to notify the Administrator in writing within thirty (30) days of any changes to Recycled Water Use Supervisor personnel or changes to contact information for the Recycled Water Use Supervisor.
17. Upon enrollment in this General Permit, if the Producers or Distributors are subject to general or individual waste discharge requirements or water reclamation requirements, the provisions of such requirements are null and void to the extent that the recycled water use is regulated by this General Permit.
18. The State Water Board will review this General Permit periodically and will revise requirements when necessary. Specifically, monitoring requirements could be revised to include CEC monitoring, if the State Water Board finds such monitoring to be necessary and appropriate, based on recommendations from the CEC Advisory Panel. Furthermore, the State Water Board would modify this General Permit if a regulatory or statutory change occurs that affects the application of the General Permit, or as necessary to ensure protection of beneficial uses. This General Permit may also be modified, rescinded and reissued, for cause. The Executive Director may also terminate coverage under this General Permit for cause. The Executive Director is hereby authorized to revise the Monitoring and Reporting Program and Attachments B, C, D, E, and F of this General Permit. Causes for modification or termination of coverage include, but are not limited to, changes to statutes, the promulgation of new regulations, adoption of new policy, modification to water quality control plans, Regional Water Board finding of “unusual circumstances” per the Recycled Water Policy, or other changes determined necessary to protect beneficial uses of waters of the state.

CERTIFICATION

The undersigned, Clerk to the Board, does hereby certify that the foregoing is a full, true, and correct copy of an order duly and regularly adopted at a meeting of the State Water Resources Control Board held on July 7, 2009.

AYE: Chairman Charles R. Hoppin
Vice Chair Frances Spivy-Weber
Board Member Arthur G. Baggett, Jr.
Board Member Tam M. Doduc

NAY: None

ABSENT: None

ABSTAIN: None



Jeanine Townsend
Clerk to the Board

**STATE WATER RESOURCES CONTROL BOARD
MONITORING AND REPORTING PROGRAM NO. 2009-0006-DWQ
GENERAL PERMIT FOR
LANDSCAPE IRRIGATION USES OF MUNICIPAL RECYCLED WATER**

This Monitoring and Reporting Program (MRP) is issued pursuant to California Water Code section 13267(f). All samples should be representative of the volume and nature of the discharge or matrix of material sampled. The time, date, and location of each sample shall be recorded on the sample chain of custody form. All analyses shall be performed in accordance with the latest edition of *Guidelines Establishing Test Procedures for Analysis of Pollutants*, promulgated by the United States Environmental Protection Agency (U.S. EPA) or other procedures approved by the Executive Director. In reporting monitoring data, the Administrator shall indicate whether any analysis was performed using a method not in conformance with U.S. EPA's Guidelines.

RECYCLED WATER PRODUCTION AND USE

For basins where the Regional Water Board has adopted a Salt and Nutrient Management Plan, compliance with any monitoring and reporting requirements of the Salt and Nutrient Management Plan is to be used in lieu of the monitoring schedule below.

Recycled water quality characteristics, based on data included in the monthly reports provided by the Producer to the Regional Water Board, shall be used in calculations to ascertain loading rates. For basins where a Regional Water Quality Control Board has not adopted a Salt and Nutrient Management Plan, the Administrator shall monitor recycled water production, distribution, and use within its service area for each respective basin / sub-basin (Attachment F) for the following parameters:

<u>Parameter</u>	<u>Units</u>	<u>Sample Type</u>	<u>Frequency</u>	
			Sampling	Reporting
Volume of recycled water ^{1, 2}	acre-feet	Varies	Monthly ³	Annual
Total number of use areas / basin ⁴	--	Observation	Annual	Annual
Total area of application	Acres	Observation	Monthly	Annual
Nitrogen application rate ^{5, 6}	lbs/acre/month	Calculated	Monthly	Annual
Salinity application rate ⁷	lbs/acre/month	Varies ¹	Monthly	Annual

¹ Estimation of the volume of recycled water shall not include other potable or non-potable "make-up" water also used to irrigate landscape, if any.

² May be estimated based on daily percentage of recycled water supplied via a non-potable water supply system.

³ May be estimated based on available data (e.g., meters read every other month or quarterly)

⁴ This parameter represents the total number of use areas within the Administrator's service area with each respective basin / sub-basin.

⁵ Nitrogen application rate shall consider nutrients contained in the recycled water, based on monthly analytical data provided by the Producer to the Regional Water Board.

⁶ Nitrogen concentrations shall be calculated and reported "as N." For example, nitrate-nitrogen = 27 mg/L of (as NO₃) shall be converted and reported as nitrate-nitrogen = 6 mg/L (as N).

⁷ Salinity application rate shall be calculated using the applied volume of recycled, actual application area, the most recent results for the concentration of total dissolved solids in the recycled water.

MONITORING AND REPORTING PROGRAM NO. 2009-0006-DWQ

Each month, the Administrator shall also verify that the recycled water has been filtered and disinfected consistent with criteria for disinfected tertiary recycled water. Based on monthly compliance data provided by the Producer to the Regional Water Board, the Administrator shall track turbidity¹ and disinfection^{2,3} parameters. Exceedances of turbidity or disinfection standards⁴ shall be documented and explained.

Each Producer and Distributor shall retain records of all monitoring information including all calibration and maintenance records, copies of all reports required by this General Permit, and records of all data used to complete the application for this General Permit. Records shall be maintained for a minimum of three years from the date of the sampling, measurement, or report. This period may be extended during the course of any unresolved investigation or litigation regarding the recycled water operation or when requested by the Executive Director.

The Administrator shall also ensure that Producers report priority pollutants to the Regional Water Board semiannually, in accordance with paragraph 7(b)(4) of the Recycled Water Policy.

ADMINISTRATOR REPORTING

By the 15 of April of each year, the Administrator shall compile information for each basin/sub-basin within its service area consistent with the format identified in Attachment F and submit the compilation to the State Water Board. The compilation shall also contain the following items:

1. A summary and discussion of the compliance record for the reporting period. If violations have occurred, the report shall also discuss the corrective actions taken and planned to bring the discharge into full compliance with this General Permit; and
2. A description of the measures employed by the Administrator during the reporting period to conduct periodic inspections of the Use Areas. The description shall include the following elements: date of inspections, description of any violations identified during the reporting period including any indications of unauthorized cross-connections, and all actions taken or planned for correcting violations, such as operation or facility modifications.

The periodic inspection shall also include an evaluation verifying that the application of recycled water to the Use Area occurs at reasonable agronomic rates. The agronomic rate evaluation shall consider all applied nutrients from all sources (directly applied and as contained in the recycled water) the seasonal nutrient demand for the specific plants being grown; soil; and climate. If the agronomic rate evaluation determines that

¹ Nephelometric Turbidity Units (NTU)

² For chlorine disinfection processes, use the product of total chlorine residual and modal contact time measured at the same point, CT (mg/L-min)

³ For other disinfection processes, the Administrator shall report using appropriate applicable standards (e.g., minimum ultra violet dose or ozone CT)

⁴ Title 22, Sections 60301.320, 60301.230 (a), and 60301.230 (b)

MONITORING AND REPORTING PROGRAM NO. 2009-0006-DWQ

exceedances of the agronomic rate may be occurring, the Administrator shall implement corrective actions to ensure recycled water use occurs at reasonable agronomic rates.

If the Administrator has previously submitted a report describing corrective actions and/or a time schedule for implementing the corrective actions, reference to the previous correspondence will be satisfactory.

3. A description of approved amendments to the Title 22 Engineering Report, if any.
 - A description of new use sites approved by CDPH. The description shall include information necessary for the CDPH to evaluate new use sites pursuant to the Title 22 Requirements. Examples of necessary information may include location of backflow prevention devices, drinking fountains, groundwater wells, et cetera.
 - Copies of approval letter(s) prepared by CDPH regarding such amendments to the Title 22 Engineering Report.

All reports submitted in response to this General Permit shall comply with the signatory requirements. Monitoring data and/or discussions submitted concerning wastewater treatment plant performance must also be signed and certified by the chief plant operator.

The Administrator shall implement the above monitoring program on the first day of the month following the issuance of the Notice of Applicability. Annual monitoring reports shall be submitted to the State Water Board. Additional information regarding the appropriate place to submit annual reports will be available on-line at the State Water Board's website⁵.

SPILL REPORTING

1. The Administrator shall ensure the Producer or Distributor reports any noncompliance that may endanger human health or the environment. The Producer or Distributor shall immediately report orally, or electronically if available, information of the noncompliance as soon as (1) the Producer or Distributor has knowledge of the discharge, (2) notification is possible, and (3) notification can be provided without substantially impeding cleanup or other emergency measures, to the appropriate Regional Water Board office⁶.

A written report shall also be provided to the State Water Board within five (5) business days of the time the Producer or Distributor becomes aware of the incident. The written report shall contain a description of the noncompliance and its cause, the period of noncompliance, the anticipated time to achieve full compliance, and the steps taken or planned, to reduce, eliminate, and prevent recurrence of the noncompliance.

2. The unauthorized discharge of 50,000 gallons or more of "disinfected tertiary recycled water" shall be reported as described in Spill Reporting No. 1. The unauthorized discharge of 1,000 gallons or more of "disinfected tertiary recycled water" shall be reported to the appropriate Regional Water Board office as soon as possible, but no later than seventy-two (72) hours after becoming aware of the unauthorized discharge.

⁵ http://www.waterboards.ca.gov/water_issues/programs/water_recycling_policy/landscape_irrigation_general_permit.shtml

⁶ http://www.waterboards.ca.gov/waterboards_map.shtml

MONITORING AND REPORTING PROGRAM NO. 2009-0006-DWQ

SIGNATORY REQUIREMENTS

All application reports or information to be submitted to the State Water Board shall be signed and certified by a duly authorized representative as follows:

1. For a corporation – by a principal executive officer or at least the level of vice president.
2. For a partnership or sole proprietorship – by a general partner or the proprietor, respectively.
3. For a municipality, state, federal, or other public agency – by either a principal executive officer or ranking elected official.

A duly authorized representative of a person may sign documents if:

- a. The authorization is made in writing by a person described in Signatory Requirements paragraphs 1, 2, or 3.
- b. The authorization specifies either an individual or position having responsibility for the overall operation of the regulated facility or activity; and
- c. The written authorization is submitted to the Executive Director.

Any person signing a document pursuant to this MRP shall make the following certification:

I declare under the penalty of law that I have personally examined and am familiar with the information submitted in this document, and that based on my inquiry of those individuals immediately responsible for obtaining the information, I believe that the information is true, accurate, and complete. I am aware that there are significant penalties for submitting false information, including the possibility of a fine and imprisonment for knowing violations.

ATTACHMENT A - DEFINITIONS

WATER QUALITY ORDER NO. 2009-0006-DWQ

GENERAL PERMIT FOR LANDSCAPE IRRIGATION USES OF MUNICIPAL RECYCLED WATER

Within this General Permit, the following terms are defined as follows:

- a. Administrator: Either a Producer or Distributor designated to administer a recycled water program necessary to fulfill the requirements of this General Permit.
- b. Agronomic Rate: The rate of application of recycled water to plants that is necessary to satisfy the plants' watering and nutritional requirements, considering supplemental water (e.g., precipitation) and supplemental nutrients (e.g., fertilizers), while preventing or strictly minimizing the amount of nutrients that pass beyond the plants' root zone.
- c. Basin: *See Groundwater Basin*
- d. Beneficial Uses: Uses of the waters of the state that may be protected against quality degradation. Uses include, but are not limited to, domestic, municipal, agricultural and industrial supply; power generation; recreation; aesthetic enjoyment; navigation; and preservation and enhancement of fish, wildlife, and other aquatic resources or preserves.
- e. California Department of Public Health (CDPH): The primary State agency responsible for protection of public health and the regulation of drinking water. The Legislature has defined several specific regulatory responsibilities of CDPH related directly or indirectly to recycled water use activities including establishment of statewide water reclamation criteria advising Regional Water Boards in the drafting of water reclamation requirements; review and approval of certain proposed water reclamation projects; abatement of contamination resulting from use of reclaimed water where public health is seriously threatened; and control of cross-connections between potable and nonpotable water systems.
- f. Disinfected Tertiary Recycled Water: Filtered and subsequently disinfected wastewater that meets the criteria defined in CCR Title 22, sections 60301.230 and 60301.320
- g. Distributor: Any combination, either in whole or in part, of a *Recycled Water Wholesaler, Recycled Water Supplier, or Recycled Water Retailer*.
- h. Drift: The water that escapes to the atmosphere as water droplets from a cooling system (Title 22, section 60301.240)

**ATTACHMENT A – DEFINITIONS
WATER QUALITY ORDER NO. 2009-0006-DWQ**

- i. Emerging Constituents/Chemicals of Emerging Concern (CECs): Any synthetic or naturally occurring chemical or any microorganism that is not commonly monitored in the environment but has the potential to enter the environment and cause known or suspected adverse ecological and/or human health effects. In some cases, release of emerging chemical or microbial contaminants to the environment has likely occurred for a long time, but may not have been recognized until new detection methods were developed. In other cases, synthesis of new chemicals or changes in use and disposal of existing chemicals can create new sources of CECs. Chemicals that have been known to be discharged at given concentrations for which protective objectives have not been established may also be identified as CECs.
- j. Engineering Report: The report filed with CDPH to produce or supply recycled water for direct reuse. The report shall clearly indicate the means for compliance with the Title 22 Requirements. (Title 22 section 60323)
- k. Groundwater Basin (basin). Groundwater resources delineated by either the California Department of Water Resources, a Water Quality Control Plan, special act, or court order.
- l. Hose Bibb: A faucet or similar device to which a common garden hose can be readily attached (Title 22 section 60301.400)
- m. Incidental Runoff: Unintended small amounts (volume) of runoff from recycled water use areas, such as over-spray from sprinklers that escapes the recycled water use area. Water leaving a recycled water use area is not considered incidental if it is part of the facility design, if it is due to excessive application, if it is due to intentional overflow or application, or if it is due to negligence.
- n. Irrigation Management Plan: All applied nutrients from all sources (directly applied and as contained in the recycled water) and the agronomic application rate and seasonal need for the specific plants being grown to assure that nutrients are not applied beyond the vegetative uptake rate and discharged into the environment.
- o. Producer: See *Recycled Water Producer*.
- p. Recycled Water: Water which, as a result of treatment of municipal wastewater, is suitable for a direct beneficial use or a controlled use that would not otherwise occur and is therefore considered a valuable resource. "Recycled water" and "reclaimed water" have the same meaning.¹

¹ California Water Code section 26

**ATTACHMENT A – DEFINITIONS
WATER QUALITY ORDER NO. 2009-0006-DWQ**

- q. Recycled Water Producer (Producer): Any public entity that produces recycled water. This includes public entities that further treat or enhance the quality of recycled water supplied by wastewater treatment facilities.
- r. Recycled Water Retailer (Distributor): As defined in Water Code section 13575(7), any retail water supplier in whose service area is located the property to which a customer requests the delivery of recycled water services.
- s. Recycled Water Supplier (Distributor): As defined in Water Code section 13575(6), any local entity, including a public agency, city, county, or private water company, that provides retail water service.
- t. Recycled Water Use Area (Use Area): An area where recycled water is to be used pursuant to this General Permit which is defined by its boundaries or project area (e.g. a golf course, residential neighborhood, school yard, park, etc.) so as to be consistent with Title 22 section 60301.920.
- u. Recycled Water User (User): A person or entity that uses recycled water.
- v. Recycled Water Wholesaler (Distributor): As defined in Water Code section 13575(5), any public entity that distributes recycled water to retail water suppliers and which has constructed, or is constructing, a recycled water distribution system.
- w. Salt and Nutrient Management Plans: Salt and nutrient plans shall be tailored to address the water quality concerns in each basin/sub-basin and may include constituents other than salt and nutrients that impact water quality in the basin/sub-basin. Such plans shall address and implement provisions, as appropriate, for all sources of salt and/or nutrients to groundwater basins, including recycled water irrigation projects.
- x. Unauthorized Discharge: (Water Code section 13529.2) Discharge of recycled water, without regard to intent or negligence, not authorized by waste discharge requirements issued pursuant to Water Code sections 13260-13274 (e.g., RWD, WDRs, waiver, etc.), 13523 (i.e., WRRs), or 13523.1 (i.e., Master Reclamation Permit).
- y. User: See *Recycled Water User*.
- z. Water Quality Objectives: The limits or levels of water quality constituents or characteristics which are established for the reasonable protection of beneficial uses of water or the prevention of nuisance within a specific area.
- aa. Water Recycling Criteria: Uniform statewide recycling criteria established in California Code of Regulations Title 22 by CDPH for each varying type of use of recycled water where the use involves the protection of public health (Water Code section 13521).

ATTACHMENT B - NOTICE OF INTENT (NOI)

FOR COVERAGE PURSUANT TO WATER QUALITY ORDER NO. 2009-0006-DWQ

**GENERAL PERMIT FOR
LANDSCAPE IRRIGATION USES OF MUNICIPAL RECYCLED WATER**

I. Distributor (Required)¹:

Agency / Organization / Name:			
Facility, if any:			
Conveyance Role (Check all that apply): <input type="checkbox"/> Recycled Water Retailer <input type="checkbox"/> Recycled Water Supplier <input type="checkbox"/> Recycled Water Wholesaler		Distributor declares responsibility for administering program necessary to fulfill the requirements of this General Permit: <input type="checkbox"/> Yes <input type="checkbox"/> No	
Description of Recycled Water Conveyance Role:			
Existing Water Reclamation Requirements (if any):		Do you request to rescind the identified existing WRRs? <input type="checkbox"/> Yes <input type="checkbox"/> No	
Mailing Address:			
City:	County:	State:	Zip:
Phone Number:		Fax Number:	
Contact Person:		E-Mail:	

II. Producer (Required)¹:

Agency / Organization:			
Facility:			
Producer declares responsibility for administering program necessary to fulfill the requirements of this General Permit: <input type="checkbox"/> Yes <input type="checkbox"/> No			
Order Number:	WDID:	Treatment: <input type="checkbox"/> Disinfected Tertiary ² <input type="checkbox"/> Advanced ³	
Existing Water Reclamation Requirements (if any):		Do you request to rescind the identified existing WRRs? <input type="checkbox"/> Yes <input type="checkbox"/> No	
Mailing Address:			
City:	County:	State:	Zip:
Phone Number:		Fax Number:	
Contact Person:		E-Mail:	

¹ Attach multiple sheets if necessary; only one administrator of this General Permit is allowed per NOI.

² As defined in California Code of Regulations Title 22, sections 60301.230 and 60301.320

³ Achieves "disinfected tertiary" quality and includes additional treatment.

**ATTACHMENT B – NOTICE OF INTENT (NOI)
WATER QUALITY ORDER NO. 2009-006-DWQ**

III. Billing Address (Required):

Agency / Organization / Name:			
Mailing Address:			
City:	County:	State:	Zip:
Phone Number:		Fax Number:	
Contact Person:		E-Mail:	

IV. Salt and Nutrient Management Plans (required)

For projects where Salt and Nutrient Management Plan is in effect.
<p>Salt and Nutrient Management Plan, approved by a Regional Water Board?</p> <p><input type="checkbox"/> Yes</p> <p><input type="checkbox"/> No; check one of the two boxes below:</p> <p><input type="checkbox"/> Under development, estimated completion date: I am actively participating in this development effort.</p> <p><input type="checkbox"/> No organized effort to develop a Salt and Nutrient Management Plan for the basin exists at this time. I will actively participate in the development of a Salt and Nutrient Management Plan when the effort commences.</p>
For projects where Salt and Nutrient Management Plan is not in effect.
<p>Antidegradation analysis completed consistent with Recycled Water Policy Paragraph 9d.(2)? <input type="checkbox"/> Yes <input type="checkbox"/> No</p>

V. Certification (Required):

<p><i>I hereby agree to meet and follow the requirements set forth in Water Quality Order No. 2009-0006-DWQ. I also agree to adhere to the Operation & Maintenance Plan, submitted herewith, and to ensure the proper use of recycled water for landscape applications. I also agree that, where an applicable Salt and Nutrient Management Plan is adopted by a Regional Water Board, I will ensure full compliance by all producers and distributors under this permit to any monitoring and reporting elements therein. Upon approval of coverage under the General Permit I will assume responsibility for administering an appropriate program necessary to fulfill the requirements of Water Quality Order No. 2009-0006-DWQ. I declare under the penalty of law that I have personally examined and am familiar with the information submitted in this document, and that based on my inquiry of those individuals immediately responsible for obtaining the information, I believe that the information is true, accurate, and complete. I am aware that there are significant penalties for submitting false information, including the possibility of a fine and imprisonment.</i></p>		
I.	Signature of Administrator:	Title:
	Printed or Typed Name:	Date:

**ATTACHMENT B – NOTICE OF INTENT (NOI)
WATER QUALITY ORDER NO. 2009-006-DWQ**

I hereby agree to meet and follow the requirements set forth in Water Quality Order No. 2009-0006-DWQ. I also agree to adhere to the Operation & Maintenance Plan, submitted herewith, and to ensure the proper use of recycled water for landscape applications. I declare under the penalty of law that I have personally examined and am familiar with the information submitted in this document, and that based on my inquiry of those individuals immediately responsible for obtaining the information, I believe that the information is true, accurate, and complete. I am aware that there are significant penalties for submitting false information, including the possibility of a fine and imprisonment.

I.	Signature of Distributor ^{4,5} :	Title:
	Printed or Typed Name:	Date:
II.	Signature of Producer ⁶ :	Title:
	Printed or Typed Name:	Date:

⁴ For additional distributors other than the Administrative Distributor.

⁵ Attach multiple sheets if necessary.

⁶ Attach multiple sheets if necessary.

ATTACHMENT C

BEST MANAGEMENT PRACTICES (BMPs)

WATER QUALITY ORDER NO. 2009-0006-DWQ

GENERAL PERMIT FOR LANDSCAPE IRRIGATION USES OF MUNICIPAL RECYCLED WATER

This menu of potential Best Management Practices (BMPs) identifies some practices for the management of the production, distribution, and use of recycled water that, in addition to requirements in law¹, will help ensure the safe and efficient use of recycled water. Many of these BMPs are also intended to minimize or eliminate conditions that cause runoff, ponding, and windblown spray (drift). Recycled Water Specification B.15 requires the Administrator to implement and ensure that all other Producers, Distributors, and Users associated with each respective NOI implement the Required BMPs identified in Section I and to consider implementing other BMPs (Sections II – IV) as appropriate for a Recycled Water Use Area.

I. REQUIRED BMPs

- A. Implementation of operations and management plan that provides for detection of leaks, and correction either within 72 hours of learning of a leak, or prior to the release of 1,000 gallons.
- B. Proper design and operation of sprinkler heads.
- C. Refraining from application during precipitation events.
- D. Management of any impoundment such that no discharge occurs unless the discharge is a result of a 25-year, 24-hour storm event or greater. In the event of an unauthorized discharge, the Executive Officer of the appropriate Regional Water Board shall be notified, as described in Provision C.16.

II. OTHER POTENTIAL BMPs: GENERAL OPERATIONAL CONTROLS

- A. The Recycled Water Use Supervisor attends regular training regarding the safe and efficient operation and maintenance of recycled water use facilities.
- B. The Recycled Water Use Supervisor ensures that all recycled water facilities are maintained, operated and repaired at all times in a manner that does not cause illness or injury to any person and in a manner that does not cause damage or injury to the real or personal property of any person or entity.
- C. Where feasible, different piping materials are used to assist in water system identification.

¹ Water Code, Health and Safety Code, California Code of Regulations, etc.

**ATTACHMENT C – BEST MANAGEMENT PRACTICES (BMPS)
WATER QUALITY ORDER NO. 2009-0006-DWQ**

III. OTHER POTENTIAL BMPs: WORKER/PUBLIC PROTECTION

- A. Workers, residents, and the public are made aware of the potential health risks associated with contact or ingestion of recycled water, and are educated about proper hygienic practices to protect themselves and their families.
- B. Workers are provided with the appropriate safety equipment and clothing during prolonged contact with recycled water.
- C. Potable drinking water is provided for workers.
- D. Toilet and washing facilities are provided.
- E. Precautions are taken to avoid contact of recycled water with food and food is not allowed into areas that are still wet with recycled water.
- F. A first aid kit is available on site, to prevent the contact of cuts and other injuries with recycled water.

IV. OTHER POTENTIAL BMPs: EFFICIENT IRRIGATION

Hardware:

- A. All irrigation systems have the appropriate equipment/hardware for the application.
- B. Irrigation system installed according to the design.
- C. Irrigation system is designed to provide as much flexibility as possible for the operation of the irrigation system.
- D. All sprinkler heads are uniform in brand, model and nozzle size. Where different arcs are needed at the same station, matched precipitation rates by changing nozzles.
- E. Sprinkler heads placed per manufacturer's recommendations and based on measured spacing between sprinkler heads.
- F. Where lower precipitation rates are required, such as on slopes, reduced nozzle size and spray angle per manufacturer's recommendations.
- G. Installed booster pumps to increase pressure where needed.
- H. Installed pressure reducers to decrease pressure where needed.
- I. Pipes sized to convey water in the quantity required by the system.
- J. Check valves installed either in-line or built into the sprinkler head assembly to minimize low head drainage after the valve has closed.
- K. Automatic flow control devices installed that shut down a system if a break or other similar high flow/low pressure situation develops during irrigation.
- L. Use centralized control systems or controllers that measure or can be programmed to use evaporation rates, or systems that use controls such as moisture sensors.

Maintenance:

- M. Routinely adjust sprinkler heads so they achieve 80% head to head coverage throughout their intended arc. There are no obstructions that would interfere with the free rotation and smooth operation of any sprinkler, (e.g., trees, tall grass, shrubs, signs, etc.). The system is routinely tested so adjustments can be made.
- N. Routinely adjust valves or pressure regulators so that the systems are operating at the pressure required by the sprinkler heads or emitters. Routinely test pressures periodically with a pressure gauge to maintain appropriate pressure levels.
- O. Routinely test the accuracy of time clocks and recalibrate or repair as necessary.

**ATTACHMENT C – BEST MANAGEMENT PRACTICES (BMPs)
WATER QUALITY ORDER NO. 2009-0006-DWQ**

- P. Repair or replace broken risers, sprinklers, valves, etc. as soon as they are discovered; replace with appropriate make and model of equipment to maintain uniformity through out the system.
- Q. Routinely check backflow devices, pumps, etc. for leaks and repair or replace as necessary.
- R. Routinely clean screens and backwash filters to keep systems operating optimally.

Management:

- S. Determined the optimum duration and frequency for irrigation cycles considering evapotranspiration, soil type, plant varieties being irrigated, climatic conditions, and any other factors affecting optimum irrigation efficiencies.
- T. Irrigation with recycled water only occurs during periods of minimal public use of the Use Area with consideration given to allow an adequate dry-out time before the Use Area will be used by the public.
- U. The frequency of respective irrigation cycles is only as often as necessary to meet the water requirements of the landscape. This is determined by measuring the amount of moisture remaining in the root zone reservoir between irrigation cycles. Moisture levels in the root zone is measured and optimized via the use of tensiometers, gypsum blocks, soil probes, the “feel method”, an on-site weather station, and or the California Irrigation Management Information System (CIMIS) to estimate soil moisture levels. These methods are reviewed, inspected, and maintained regularly to ensure accuracy and reliability.
- V. Use automatic rain shut-off devices to reduce irrigation if significant rainfall occurs.
- W. Use multiple rain shut-off devices to reduce ponding if precipitation rate is higher than the infiltration rate of the soil.
- X. Majority of irrigation occurs in the evening or early morning to avoid the heat and/or windy parts of the day.
- Y. Irrigated areas grouped into zones of similar water use.
- Z. As needed, aerate the soil to improve infiltration of air and water into the soil.
- AA. Perform good horticultural practices; fertilization, mowing, de-thatching, aeration, and pest control, as necessary to create the best growing environment for landscape vegetation.
- BB. Provided infiltration areas at the lowest elevation of the Use Area.
- CC. Installed storm drain inlet valves or plugs to contain accidental discharges during dry weather
- DD. Implemented low impact development practices to minimize runoff that contains recycled water.
- EE. Employ water budgeting using evapotranspiration data from CIMIS or an on-site weather station and crop coefficients from Water Use Classification of Landscape Species (WUCOLS)
- FF. Dedicated landscape water meters for monitoring of water budget and leak detection.
- GG. Conformance to local or the State Water Efficient Landscape Ordinance.
- HH. Education of residents, customers and employees regarding the importance of efficient water use.
- II. Each site supervisor has been provided a conductivity tester as a tool to help them determine the difference between recycled water and potable water.

ATTACHMENT D
RECYCLED WATER USE SIGNAGE
FOR
WATER QUALITY ORDER NO. 2009-0006-DWQ
GENERAL PERMIT FOR
LANDSCAPE IRRIGATION USES OF MUNICIPAL RECYCLED WATER



ATTACHMENT E - NOTICE OF TERMINATION

OF COVERAGE PURSUANT TO WATER QUALITY ORDER NO. 2009-0006-DWQ

**GENERAL PERMIT FOR
LANDSCAPE IRRIGATION USES OF MUNICIPAL RECYCLED WATER**

I. Reason for Termination (Required):

<input type="checkbox"/> Cessation of Recycled Water Use <input type="checkbox"/> Recycled Water not treated to required standards <input type="checkbox"/> Change of Ownership <input type="checkbox"/> Other: _____	
Notice of Applicability Order No. 2009-0006-DWQ Date Issued: _____	WDID: _____

II. Producer (Required)¹:

Agency / Organization / Name:	
Facility:	
Order Number:	Facility WDID:

III. Distributor (Required)²:

Agency / Organization / Name:	
Facility:	

IV. Certification (Required)³:

<i>I certify under penalty of law that all authorizations for uses of recycled water, have been eliminated or that I am no longer the Producer or Distributor of recycled water as defined in the Notice of Applicability identified in Section I. I understand that by submitting this Notice of Termination I am no longer authorized to produce or distribute recycled water pursuant to the Notice of Applicability identified in Section I. I also understand that submittal of this Notice of Termination does not release any of the subject entities from liability for any violations of, Water Quality Order No. 2009-0006-DWQ or the California Water Code, or the California Code of Regulations.</i>		
I.	Signature of Producer :	Title:
	Printed or Typed Name:	Date:
II.	Signature of Distributor :	Title:
	Printed or Typed Name:	Date:

¹ Attach multiple sheets if necessary.
² Attach multiple sheets if necessary.
³ Attach multiple sheets if necessary.

**ATTACHMENT F – BASIN/SUB-BASIN
ANNUAL REPORTING FORMAT**

WATER QUALITY ORDER NO. 2009-0006-DWQ

**GENERAL PERMIT FOR
LANDSCAPE IRRIGATION USES OF MUNICIPAL RECYCLED WATER**

I. Administrator:

Agency / Organization:				
Facility:				
Landscape Irrigation General Permit Number:		Landscape Irrigation General Permit WDID:		
Mailing Address:				
City:	County:	State :	Zip:	Phone Number:
Contact Person:		E-Mail:		
Any CDPH Approved Amendments to the Title 22 Engineering Report? <input type="checkbox"/> Yes <input type="checkbox"/> No				

II. Recycled Water Distributor Information¹:

Agency / Organization:				
Facility:				
Landscape Irrigation General Permit Number:		Landscape Irrigation General Permit WDID:		
Distributor Recycled Water Conveyance Role (Check all that apply): <input type="checkbox"/> Recycled Water Retailer <input type="checkbox"/> Recycled Water Wholesaler <input type="checkbox"/> Recycled Water Supplier				
Description of Recycled Water Conveyance Role:				
Mailing Address:				
City:	County:	State :	Zip:	Phone Number:
Contact Person:		E-Mail:		

¹ Attach multiple sheets if necessary.

**ATTACHMENT F – BASIN/SUB-BASIN
ANNUAL REPORTING FORMAT
WATER QUALITY ORDER NO. 2009-0006-DWQ**

III. Recycled Water Producer Information²:

Agency / Organization:			
Facility:			
WDRs Order Number ³ :		Additional Order Numbers ⁴ :	
Mailing Address:			
City:	County:	State:	Zip:
Phone Number:		Fax Number:	
Contact Person:		E-Mail:	

IV. Use Area Information:

Name:			
Street (Including address, if any):			
Nearest Cross Street(s):		County:	
Latitude/Longitude (From Center): _____ Deg _____ Min _____ Sec North _____ Deg _____ Min _____ Sec West			
Method of data collection: _____.			
Type(s) of Landscape Irrigation (Check all that apply): <input type="checkbox"/> Park, Greenbelt, or Playground <input type="checkbox"/> School Yard <input type="checkbox"/> Athletic Field <input type="checkbox"/> Residential Landscaping, Common Area <input type="checkbox"/> Commercial Landscaping, Common Area <input type="checkbox"/> Golf Course <input type="checkbox"/> Industrial Landscaping, Common Area <input type="checkbox"/> Freeway, Highway, and Street Landscaping <input type="checkbox"/> Cemetery			
Basin / Sub-basin No., if any ²		Basin / Sub-basin name, if any ²	
Beneficial Uses of Groundwater within Basin / Sub-basin. (Select all that apply) ² <input type="checkbox"/> Agricultural Supply (AGR) <input type="checkbox"/> Industrial Service Supply (IND)..... <input type="checkbox"/> Water Contact Recreation (REC I) <input type="checkbox"/> Aquaculture (AQUA)..... <input type="checkbox"/> Municipal Supply (MUN) <input type="checkbox"/> Wildlife Habitat (WLD) <input type="checkbox"/> Industrial Process Supply (PRO) <input type="checkbox"/> Noncontact Water Recreation (REC II) <input type="checkbox"/> Other			

² Attach multiple sheets if necessary.

³ Waste Discharge Requirements (WDRs) Order number for the order that authorizes discharge from the Producer's wastewater treatment plant (e.g., an order number for an NPDES Permit)

⁴ Other WDRs order numbers for the wastewater treatment plant, enforcement orders, water reclamation requirements, etc.

**ATTACHMENT F – BASIN/SUB-BASIN
ANNUAL REPORTING FORMAT
WATER QUALITY ORDER NO. 2009-0006-DWQ**

V. Recycled Water Use Supervisor:

Agency / Organization / Name:			
Mailing Address:			
City:	County:	State:	Zip
Phone Number:		Fax Number:	
Contact Person:		E-Mail:	
Date of most recent training / certification as Recycled Water Use Supervisor:		Training / certification provided by:	

VI. Annual Recycled Water Report for the Basin / Sub-basin

Month	Volume of Recycled Water (Ac-ft.)	Total Number of Use Areas / basin	Area of Application (Acres)	Nitrogen Application Rate (lbs/Acre/Month)	Salinity Application Rate (lbs/Acre/Month)
January					
February					
March					
April					
May					
June					
July					
August					
September					
October					
November					
December					
Annual Average¹:					
Total:					

¹ Mean average value for the calendar year.

**ATTACHMENT F – BASIN/SUB-BASIN
ANNUAL REPORTING FORMAT
WATER QUALITY ORDER NO. 2009-0006-DWQ**

OTHER DOCUMENTATION

Describe approved amendments to the approved Title 22 Engineering Report. Include copies of approval letter(s) prepared by CDPH regarding such amendments to the Title 22 Engineering Report if any.			
Provide a description of new use sites approved by CDPH. The description shall include information necessary for the CDPH to evaluate new use sites pursuant to the Title 22 Requirements. Examples of necessary information may include location of backflow prevention devices, drinking fountains, groundwater wells, et cetera.			
Describe the nature, extent, and cause of any exceedances of turbidity or disinfection standards, if any. Discuss corrective actions taken or planned to resolve the exceedances of turbidity or disinfection standards			
PERIODIC INSPECTION OF RECYCLED WATER USE AREA			
Cross-connection Prevention			
Recycled Water Use Area Name	Date of Inspection(s) for cross-connection prevention:	Description of violations identified, if any:	Actions taken or planned for correcting violations:
Agronomic Rate Evaluation			
Average Agronomic Demand (lbs/acre/year)		Average Nitrogen application (lbs/acre/year)	
Corrective actions taken to ensure recycled water use occurs at reasonable agronomic rates			

Meeting Time: 9:00 AM to 11:00 AM Page: 1 of 5
 Meeting Location: Conference Room at CCWD Date: September 15, 2016
 Meeting Date: September 9, 2016 K/J Job No.: 1670021.00
 Project: La Contenta Wastewater Master Plan Project
 Topic(s): Kick-off Meeting

Meeting Attendees:

<i>Kennedy/Jenks</i>		<i>Calaveras County Water District (CCWD)</i>	
Kevin Kennedy	Bob Godwin	Jesse Hampton	John Brown
Chantelle Garvin	Robert Creamer	Benjamin Stopper	Teresa Tanaka

Subject:

Introductions

See meeting attendees listed above.

Master Plan Components

Development and Other Key Criteria

Under current conditions, Calaveras County Water District (CCWD) staff indicated that they think that the La Contenta wastewater system can accommodate between 100 and 150 new equivalent dwelling units (EDUs) and that the system is currently limited by storage and disposal capacity.

The County's General Plan Environmental Impact Report (EIR) is scheduled to be completed by November 2016. A draft of the County's General Plan is scheduled to be completed and available by September 22nd, which will include an updated land use map in Geographic Information System (GIS) format. Currently, CCWD does not have GIS. Meeting discussion results indicated that K/J should obtain this map and use it to form the basis of the updated development projections. It is likely that the updated land use map, along with development projections and Assessment District 604 information, will need to be summarized, circulated and reviewed with the District. The County's General Plan and land use map will likely be located on the County website under General Plan Update (<http://planning.calaverasgov.us/GeneralPlanUpdate.aspx>). Preliminary review indicate that some developments may have been renamed (Woodgate same as Vista Plaza 2); a future development coordination meeting will likely be required.

K/J had proposed workshops in their proposal to discuss and finalize design criteria with the District. Bob suggested developing a technical memorandum summarizing key design criteria for District review and comment. This approach is similar to what PBI is doing for the water master plans.

CCWD's 2015 Urban Water Management Plan was recently completed and has relatively conservative population growth trends. This report is available on the CCWD website. Growth rates described in this report are based on Department of Finance's projections which are considered to be conservative.

CCWD is considering purchasing a few parcels located immediately southwest of the La Contenta Wastewater Treatment Plant along New Hogan Road to provide additional storage and treated effluent disposal capacity. The parcels surround a portion of the Lower Effluent Storage Pond. In total, the parcels

Draft Meeting Minutes No. 1

La Contenta Wastewater Master Plan Project

Kick-off Meeting Minutes

Page 2 of 5

are approximately 80 acres; however, this information needs to be confirmed with/by the District along with the estimated purchase price.

CCWD would like K/J to review the validity/application of the District's standard unit flow rate of 195 gallons per day per equivalent dwelling unit (gpd/EDU). Most likely, this will be accomplished by comparing historic unit flows with the 195 gpd/EDU standard for the past 10 to 20 years. K/J to prepare Request for Information and include historic unit flow factor data into the request.

A developer (i.e., Voorjees) is believed to have recently completed a housing project and will be selling several new homes soon.

La Contenta wastewater and Jenny Lind water development projections should be consistent and represent the same level and timing of development for common service areas and connections.

Wastewater Characteristics

K/J recent experience indicates that pollutant (e.g., BOD, TSS and ammonia) loads can become more of a trigger / driver than flows due to water conservation. It is likely that wastewater characteristics will require both description of current flows and pollutant loads, where pollutants are the constituents described in the existing discharge permit.

Existing Facilities and Rated Capacities

CCWD prepared a Report of Waste Discharge in April 2013 which describes the average dry weather flow (ADWF) capacity of the existing La Contenta wastewater system to 0.2 million gallons per day (MGD). Some existing components, unit processes, equipment, etc., have excess capacity which is intended to be leveraged as influent wastewater flows increase.

Collection System

The existing collection system experiences relatively high levels of infiltration and inflow (I/I) with 2006 being the most significant. Recently adopted flood maps indicate that a portion of the collection system is within the 100 year flood plain. CCWD would like recommendations as to how to improve and/or rectify and/or address high I/I flows (e.g., flow measurement to identify problem areas, bolt down manhole lids, etc.).

The Huckleberry Pumping Station is believed to be located within the 100-year flood plain and next to a creek. CCWD has measured I/I flows of about 600,000 gallons per day (gpd) during a heavy rain event, and in 2006, flows almost overflowed into the creek. The collection system is relatively new and should be water tight; I/I is most likely coming into the collection system through various openings. There are three pumps at the station and a relatively small wet well; if something happens to the pumps, the station has no storage and little flood control. CCWD has installed sand bags around the property perimeter as an added safety precaution; a longer term flood protection solution should be recommended in the master plan. The wet well is relatively small and pumping up the hill to the La Contenta WWTP is proving to be an operational challenge. The pumps cycle on and off frequently and deliver influent flows in pulses to the

Draft Meeting Minutes No. 1

La Contenta Wastewater Master Plan Project

Kick-off Meeting Minutes

Page 3 of 5

WWTP which is problematic for certain unit processes. According to CCWD, the majority of the total dynamic head is static lift, leaving little operating flexibility for the variable speed drives to vary pumped flows. The station is located in a residential area and equipped with a biofilter for odor control. K/J to consider that increasing the size of the wet well may cause increased odors and require odor control improvements to mitigate.

Flood protection, installation of an equalization pond¹, a separate pumping station², and increasing the size of the Huckleberry Pumping Station wet well are all possible solutions that were discussed for the pumping station and will be considered. There are vacant fields next to the creek and pumping station which use to be part of the original wastewater treatment plant.

Wastewater Treatment

The existing Biolac extended aeration basin has not been taken out of service for sludge removal. It is possible that a large portion of the basin is currently occupied by settled accumulated sludge.

Various ways for configuring a new equalization basin, extended aeration basin and secondary clarifiers were discussed (e.g., new secondary clarifier next to existing Biolac basin, new Biolac and secondary clarifier on other side of plant towards maintenance shop or other side of transformer; reconfigure existing Biolac to serve as equalization basin) along with the installation of two smaller or one large clarifier.

A second Biolac may be a good option, however, CCWD would like other processes reviewed (e.g., Aeromod and Biolac competitors) in light of high I/I and want traditional circular clarifiers (no Biolac intergral clarifiers).

There are five Dynasand filters (each with about 250 gpm capacity) followed by UV disinfection. Influent flow pulses delivered to the WWTP from the Huckleberry Pumping Station and low flows during off-peak hours are problematic for extended aeration, filtration and disinfection performance.

CCWD would like to continue to leverage the use of natural treatment systems whenever possible; this avoids the need for Grade 5 operators.

The WWTP is located on a hill, which could present a problem with respect to hydraulic and pumping (energy) requirements.

Biosolids are currently being hauled to the Potrero Landfill (near Suisun City) and/or Synagro (Harold?). Synagro is closer but Potrero is preferred because of their testing requirements. CCWD may desire to create a regional biosolids facility at the La Contenta WWTP to consolidate solids, dewater and treat solids to Class B or A (or a combination thereof) prior to hauling to landfill for disposal. Funds to install the facility would likely be limited to any estimated hauling and tipping costs reductions. K/J to request hauling and tipping fee data to determine what the level of savings could potentially be obtained with a regional biosolids facility. CCWD staff indicated that dewatered solids are in the 20 to 25% range. If the biosolids

¹ At either the Huckleberry Pumping Station or La Contenta WWTP site.

² That conveys wastewater to La Contenta WWTP separately from the Huckleberry Pumping Station and potentially cross connects to the Huckleberry Pumping Station to increase conveyance system reliability.

Draft Meeting Minutes No. 1

La Contenta Wastewater Master Plan Project
Kick-off Meeting Minutes
Page 4 of 5

were treated to a Class A standard, the biosolids could be sold locally to generate revenue. Solids from CCWD's Arnold, Copper Cove, Forest Meadows, La Contenta, West Point and Vallecito WWTP's could be stabilized along with solids from the Jenny Lind WTP and used to generate gas for energy recovery. Hauling costs could be reduced by using larger shipping containers.

Storage

Currently storage and treated effluent disposal limits the overall capacity of the La Contenta wastewater system. The manner in which recycled water is delivered to Pond 7 has been modified and is described in the April 2013 Report of Waste Discharge. At a minimum, La Contenta Golf Course recycled water irrigation demand projections should be updated to reflect how Pond 7 is now being operated.

Disposal

Currently about 200 acre foot per year (AFY) of recycled water is produced by the La Contenta WWTP and beneficially disposed of via recycled water irrigation at the La Contenta Golf Course. According to CCWD, the La Content golf course can use significantly more recycled water as described in a report previously developed by Condor Earth.³ K/J's preliminary review of the Condor Earth Report indicates that the total estimated agronomic irrigation volume of the La Contenta Golf Course was 283 acre-feet, which is only slightly higher than currently recycled water demand. CCWD supplies both raw and recycled water to the golf course. K/J to request historic records for raw and recycled water to estimate future projected demand.

Indirect Potable Reuse (IPR) was discussed and its potential application as a long-term treated effluent/recycled water disposal option. CCWD does not feel that this option is viable at this time given that it has not been implemented within California. Other disposal options discussed at the meeting included residential front and backyard irrigation and year round and seasonal NPDES. A critical consideration / limitation for the wastewater master plan will be the amount of storage and disposal capacity described and the level of detail. Meeting discussions indicate that the initial storage and disposal needs and improvements will be described in detail (Phase 1) and future (after Phase 1) needs and improvements will be limited to describing total needs with respect to total volume (acre-foot), disposal (AFY) and estimated land requirements (acres).

Schedule

CCWD would like the draft La Contenta Wastewater Master Plan circulated for review and comment by the end of the year. Copper Cover Wastewater Master Plan to start a couple of months later.

Decisions, Action Items and Next Steps

- 1) Attendees to review minutes and provide comments within a week (by September 22, 2016).
- 2) K/J to develop a consolidated Request for Information (RFI) listing all data requested including the following

³ Calculation of Agronomic Rates for Landscape Irrigation of recycled water at La Contenta Golf Course (May 10, 2012)

Draft Meeting Minutes No. 1

La Contenta Wastewater Master Plan Project

Kick-off Meeting Minutes

Page 5 of 5

items:

- a) Descriptions (e.g., APNs, area (acres), estimated purchase price, etc.) of potential parcels to be purchased by CCWD.
 - b) Historic unit flows (gallon per day per equivalent dwelling unit basis) for last 10 to 20 years (span previous master plan and master plan update which were 2003 and 2005, respectively).
 - c) CCWD spreadsheet estimating wastewater system capacity versus flow; served as basis for 100 to 150 EDU capacity.
 - d) DWR growth estimate Excel files.
 - e) Grant application associated with hauling solid waste organic out of county.
- 3) K/J to obtain the County's General Plan EIR Land Use Map and schedule meeting with CCWD to go over development plan (likely limited to Bob and Robert).
- 4) K/J to incorporate the following elements into the wastewater master plan project:
- a) Development projections will require close coordination.
 - b) Technical memorandum summarizing key design criteria for CCWD review and comment as opposed to workshops.
 - c) Description and review of historic unit flow factors; comparison to current 195 gpd/EDU standard and recommendation.
 - d) Land currently being considered for CCWD purchase to represent capacity associated with recommended Phase 1 improvements.
 - e) Consider flood protection at the Huckleberry Pump Station and conveyance redundancy when laying out the future collection system.
 - f) Funds to build a regional biosolids facility would likely be limited to savings associated with reduced labor, handling, storage, disposal (tipping) fees and costs.

By:

Distribution: Meeting Attendees

Kevin Kennedy, P.E.

Meeting Time: 1:30 PM to 3:00 PM

Page: 1 of 4

Meeting Location: Conference Room at CCWD

Date: October 18, 2016

Meeting Date: October 12, 2016

K/J Job No.: 1670021.00

Project: La Contenta Wastewater Master Plan Project

Topic(s): Development Meeting

Meeting Attendees:

Kennedy/Jenks

Calaveras County Water District (CCWD)

Kevin Kennedy

Bob Godwin

Charles Palmer

Jesse Hampton

Chantelle Garvin

Robert Creamer

Teresa Tanaka

Subject:

Introductions

See meeting attendees listed above.

Development Projections

Two sets of planned, pending and approved development projections were discussed (see Attachments). CCWD's desire is to determine specific steps needed to serve planned, pending and approved developments (on the order of 1,112 ESFUs).

The General Plan Map associated with the County's General Plan Environmental Impact Report has been posted on the County's website. CCWD indicated that this map may be used as a basis for development projections. Map has been downloaded by K/J for use in this project. A copy will be transmitted to CCWD for their files.

CCWD was provided with a markup of the General Plan Land Use Map indicating K/J's understanding of AD 604 boundaries. The following specific steps were discussed and will be used for the La Contenta wastewater master plan for development projections:

1. CCWD to review K/J provided map and comment regarding understanding of AD604 boundaries. Also, CCWD should indicate which areas may be considered for service area expansion in the future. CCWD to provide review comments in hardcopy format to K/J.
2. K/J to obtain relatively up to date aerial of AD604 and adjacent lands and superimpose update AD604 boundaries, following incorporation of CCWD's review of K/J AD604 boundary and potential future service areas).
3. CCWD to identify and illustrate the planned, pending and approved developments presented to the Engineering Committee on map to be provided by K/J. Map to also illustrate existing and future potential service areas.
4. Aerial in conjunction with land use map, to be used to help identify service area infill lots and incorporate into subsequent development projections
5. CCWD and K/J to coordinate, then meet with Calaveras County planning staff. Objective of the meeting will be (a) obtain feedback regarding map (AD604 boundaries and existing and future

Draft Meeting Minutes No. 2

La Contenta Wastewater Master Plan Project

Development Meeting Minutes

Page 2 of 4

service areas), (b) discuss planned, pending and approved developments and their status, and (c) obtain up to date information from the County regarding recent and ongoing development activity.

6. K/J to collect and incorporate meeting results into and draft development map and projections for CCWD review and comment.

CCWD staff was recently informed that Voorjees (local developer) has resumed activity within the CCWD service area and additional connections are expected in the near future.

Land Costs

K/J prepared preliminary development, ADWF and land disposal projections based on planned, pending and approved developments and the District's existing ADWF unit flow factor of 195 gpd/ESFU (see Attachments). Actual costs are impacted by (a) how much of the land is actually usable for irrigation and (b) how much land is required for setbacks. Preliminary estimations indicate that 208 to 458 acres of land could be required to accommodate an ADWF of 0.42 MGD assuming effluent equivalent to an ADWF of 0.2 MGD is routed to the golf course for disposal. Preliminary estimates indicate that land costs could be between \$4.4 and \$9.7 million or \$3,957 to \$8,732 per ESFU.

Effluent Disposal

Negotiations are underway with the property owner of the parcel north of the Lower Effluent Storage Pond (LESP). The 52 acre site was appraised at \$550,000 and the property owner is asking \$850,000.

CCWD staff thinks groundwater recharge/percolation ponds may be a good option to consider if viable land with adequate geological conditions could be located relatively close to the WWTP. CCWD would like to check permeability of the triangle-shaped parcel near Valley Springs that CCWD owns, as well as the property north of the LESP.

The following is a listing of CCWD's preference for effluent disposal and priority:

- 1) Optimize and maximize beneficial reuse at the La Contenta Golf Course.
- 2) Identify use / course of action for existing 52 acre triangular parcel near Valley Springs.
- 3). Describe and leverage, if viable, the use of turbo misters, fill stations, dust control and other past disposal methods used by CCWD to minimize the need to acquire land.
- 4) Identify use / course of action for 50 acre site above LESP that CCWD is considering.
- 5) Seasonal Discharge
- 6) Golf Course Purple Pipe Extension / Residential Reuse
- 7) Percolation

CCWD staff would like to explore the possibility of deepening and widening the existing storage ponds.

Regional Biosolids

CCWD submitted an application to the State's CWSRF Program to receive grant funding for a regional biosolids facility. CCWD would like to treat biosolids to a point that land application and/or selling on the open market is possible depending on costs.

CCWD would also like to know if receiving septage is viable, given that there is no place currently to

Draft Meeting Minutes No. 2

La Contenta Wastewater Master Plan Project
Development Meeting Minutes
Page 3 of 4

dispose of septage in the County.

Valley Springs Public Utilities District

VSPUD is considering regionalization with CCWD. However, K/J is to move forward with the La Contenta Wastewater System Master Plan under the basis that VSPUD will continue to provide separate, independent sewer services.

Next Steps

Treatment methods were mentioned briefly at the meeting and will be followed up with more discussion in subsequent meeting. Options to consider are:

- 1) Enlarge Biolac; replace internal clarifier with external circular secondary clarifier. May require temporary facilities during construction and separate influent equalization.
- 2) Replace Biolac; install an alternative technology; leverage existing for influent equalization.
- 3) Combination thereof. Maximize Biolac capacity, get growth going, then transfer to alternative treatment technology.

K/J to use the land use map provided by CCWD staff to develop an aerial map of the District with current and buildout conditions.

Schedule

CCWD would like the draft La Contenta Wastewater Master Plan circulated for review and comment by the end of the year. To keep this schedule, development projections should be completed within a month, at the most. This means that the County meeting should occur before the end of October 2016.

Decisions and Action Items

- 1) Attendees to review minutes and provide comments within a week (by October 19, 2016).
- 2) K/J to update Request for Information (RFI) to reflect the following items:
 - a) Land use map with planned, pending and approved development, AD 604, and La Contenta boundaries identified by CCWD staff.
 - b) Geotechnical information available from CCWD test well sites or the New Hogan Dam construction.
 - c) Application to CWSRF for regional biosolids facility.
 - d) Remaining items from RFI #1 - Response and Comment Table.
 - e) Historical Golf Course demands, including recycled water demands and New Hogan demands.

Draft Meeting Minutes No. 2
La Contenta Wastewater Master Plan Project
Development Meeting Minutes
Page 4 of 4

Distribution: Meeting Attendees

By:

Kevin Kennedy, P.E.

Meeting Time: 11:00 AM to 12:00 PM Page: 1 of 3
 Meeting Location: Conference Call Date: December 2, 2016
 Meeting Date: December 1, 2016 K/J Job No.: 1670021.00
 Project: La Contenta Wastewater System Master Plan Project
 Topic(s): Treatment Process

Meeting Attendees:

<i>Kennedy/Jenks</i>	<i>CCWD</i>	<i>Parkson</i>
Kevin Kennedy	Bob Godwin	Benjamin Stopper
Chantelle Garvin	Charles Palmer	Teresa Tanaka
	Jesse Hampton	Rakesh

Subject:

Introductions

See meeting attendees listed above.

Discussion

1. Activated sludge Basin

Rated capacity of existing Biolac System (aeration basin and integral clarifier unit) and historic performance.

Parkson confirms the existing Biolac basin, built in 1992, has a design capacity of 0.4 MGD assuming 225 mg/L BOD, 40 mg/L TKN and 25 mg/L NH₄ as Nitrogen, and a 30 hour detention time. When the WWTP was reclassified in 2006 as having a capacity of .2 MGD, the BOD was assumed to be 450 mg/L. CCWD will confirm the BOD concentration entering the WWTP to determine the estimated capacity of the Biolac basin.

The weakness of the Biolac basin with respect to BOD loading is the relatively high minimum operating range. The minimum BOD loading is 4-5 pounds per 1000 cu-ft basin with a minimum 20-day mean cell residence time.

Integral Clarifier Improvements

When the Biolac basin was constructed in 1992 the performance rating was such that effluent BOD and TSS concentrations were 10 and 15 mg/L, respectively. Today, the performance for effluent BOD and TSS concentrations are 10 mg/L each. This is assuming loading conditions are within the operating range.

The following modifications have been made to the integral clarifier:

- The traditional curtain baffle has been replaced by a concrete wall, which appears to be more durable;
- Flow into the clarifiers is now at the bottom of the clarifier instead of the top;
- There is a new flow distribution channel. It is longer and has more orifices for flow control;
- The bottom is V-shaped to aid in rapid sludge removal;

Draft Meeting Minutes No. 1

La Contenta Wastewater Master Plan Project

Kick-off Meeting Minutes

Page 2 of 3

- An automated, fully retractable skimming device has been added;
- Fillets have been added to the square corners; and
- The flat attached to the curtain has been eliminated, which caused settling in the aeration basin.

A few WWTPs (not typical) prefer submersible pumps with which to control the amount of RAS being pumped back to the aeration basin, independently of the amount of air lifted into the basin. CCWD has indicated an interest in this option, as well as flow meters to optimize process performance. Could upgrade controls

One option, to provide redundancy, is to add flapper gates to the integral clarifier. It was suggested that the aeration basin could also be divided to provide redundancy; Parkson agrees it is possible.

A second hopper could be installed. In that case the sloped wall would be replaced with a vertical wall.

Partial flume?

Increased Biolac aeration capacity

The capacity could be increased to .5 MGD by adding the maximum number (5) of diffuser tubes per sub assembly. The basin currently has 7 aeration chains, each with 6 sub-assemblies and each sub assembly currently has 3 diffuser tubes. In the future, if denitrification is required the Biolac WaveOx can be installed which allows one additional sub assembly per aeration chain. The capacity, however, would not increase beyond .5 MGD.

VDF blowers have been added to provide more control for optimum aeration.

External Clarifiers

It is possible to add an external clarifier, but 99% of Parkson customers use the integral clarifier.

2. Other approaches

Currently, the clarifier would need to be taken out of service for approximately 60 days to remove the curtain baffle and retrofit with the concrete wall. At flows less than .4 MGD, for redundancy, it is common to operate one aeration basin and two integral clarifiers. Beyond .4 MGD construction of a second Biolac basin is common.

3. Screening

There have been improvements to the aquaguard design. The screening is farther away to produce less carry over. The brush has been improved and a compactor has been added.

CCWD mentioned they do not have a brush and Parkson is sending a representative to take a look.

CCWD is currently using a grinder (solids are not being removed) which is located at the pump station.

Draft Meeting Minutes No. 1

La Contenta Wastewater Master Plan Project

Kick-off Meeting Minutes

Page 3 of 3

Action Items and Next Steps

1. Parkson to provide CCWD with drawing of different process configurations.
2. Parkson to send a representative to La Contenta to asses Aquaguard.
3. CCWD to provide wastewater characteristics.
4. K/J to provide Parkson a list of desired bid items.

Distribution: Meeting Attendees

By:

Kevin Kennedy, P.E.

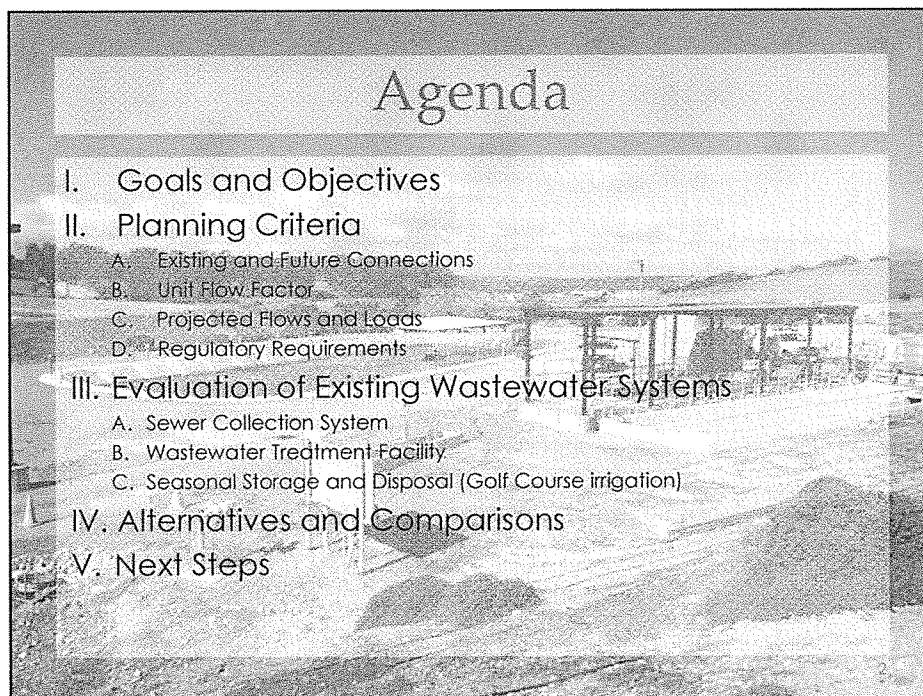
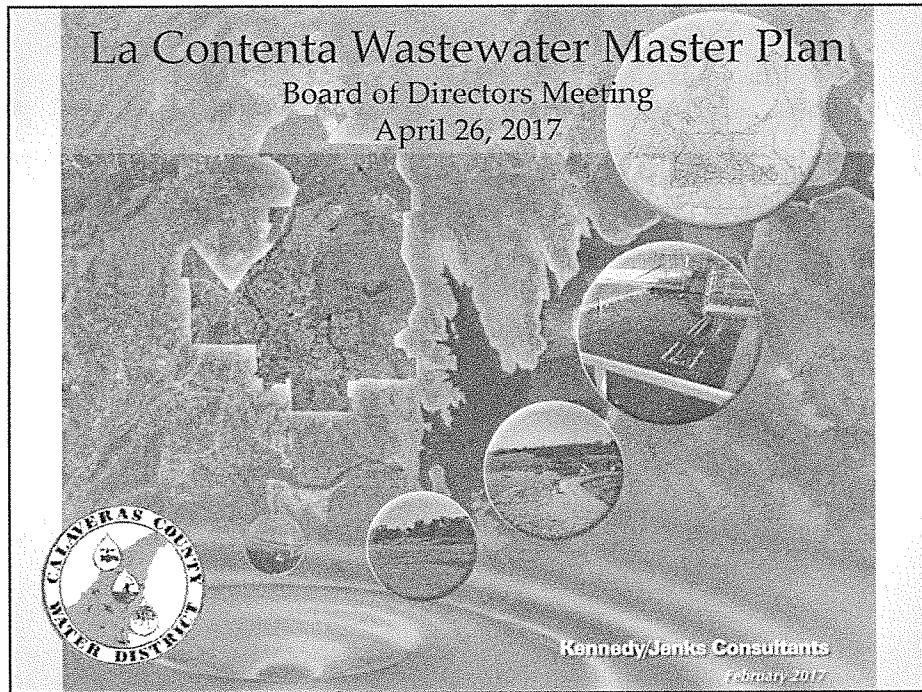

Master Plan Goals and Objectives

- **Goals:**
 - Develop a master plan:
 - Tailored specifically for the District's La Contenta Wastewater System
 - Accommodates planned growth
 - Series of cost-effective and phased improvements
 - District's upcoming capital improvements and financial plans
- **Objectives:**
 - Define existing and planned service area, growth and project flows and loads,
 - Compare approaches to increase capacity, comply with regulations and improve operations,
 - Identify and describe triggers for recommended improvements,
 - Recommend series of phased, cost-effective solutions that meet near-term (Phase 1) growth projections, and
 - Determine and describe facility improvements needed for Buildout.

Complete the Master Plan and obtain approval from the District Board of Directors at Future Board Meeting (July 26, 2017)

Planning Criteria

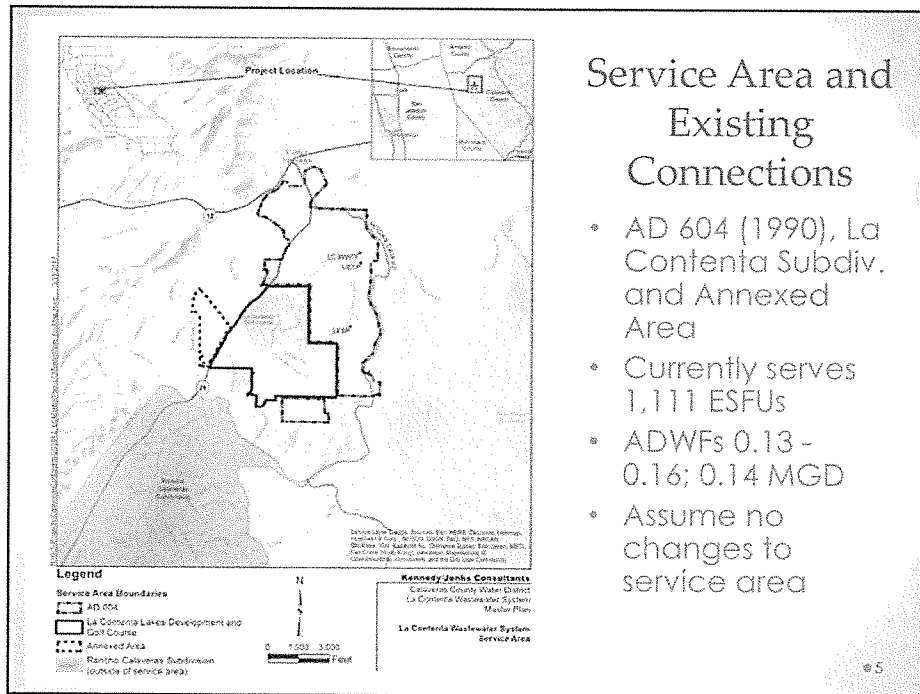

Service Area and Existing Connections

- AD 604 (1990), La Contenta Subdiv. and Annexed Area
- Currently serves 1,111 ESFUs
- ADWFs 0.13 - 0.16; 0.14 MGD
- Assume no changes to service area

05

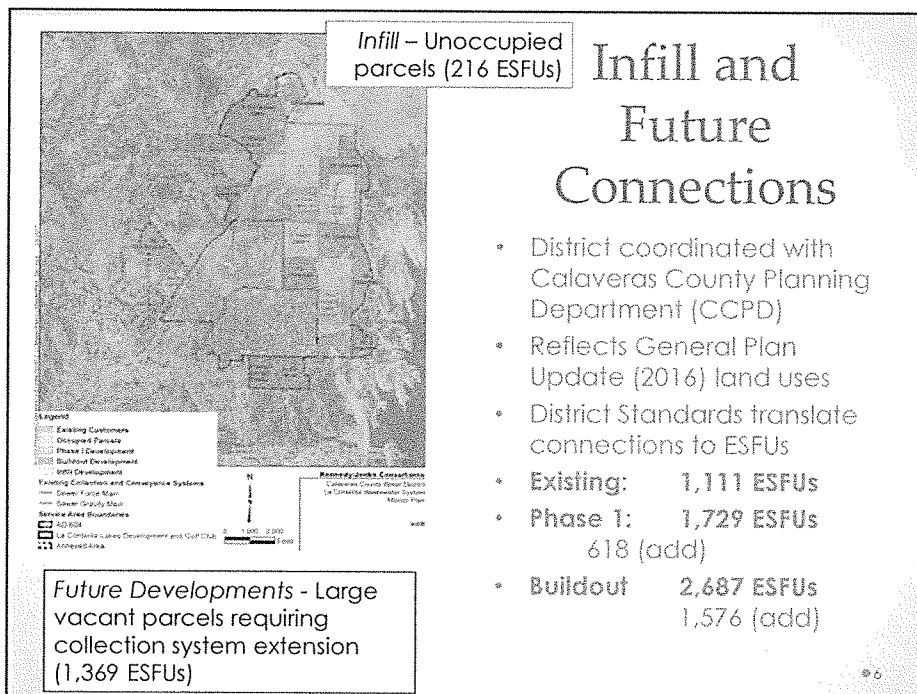

Infill and Future Connections

- District coordinated with Calaveras County Planning Department (CCPD)
- Reflects General Plan Update (2016) land uses
- District Standards translate connections to ESFUs
- Existing: 1,111 ESFUs
- Phase 1: 1,729 ESFUs
618 (add)
- Buildout 2,687 ESFUs
1,576 (add)

Future Developments - Large vacant parcels requiring collection system extension (1,369 ESFUs)

06

Development Projections

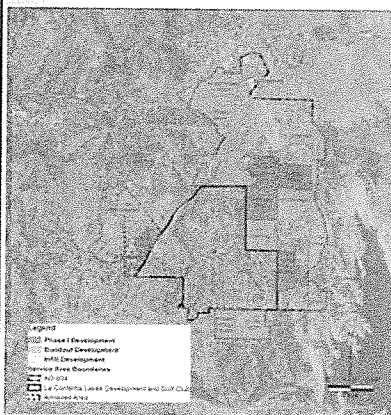

Table 1. Future Development Projections

Reference No.	Future Developments	Description and Status	ESFUs
Phase I			
1	New Hogan Lake Estates	83 units; 2 built	83
2	Hogan Oaks I	51 residential homes	51
3	Hogan Oaks II	143 residential plus multi-dwelling units	143
4	Cold Creek Estates III	75 residential units; approved	75
5	Medical Center	Buildout 100,000 sq. ft. 1 ESFU/7,000 sq. ft.	50
6	Unnamed		13
Phase I Subtotal			419
Buildout			
7	Mission Ranch	Pending	146
8	Old Golden Oaks	Pending	96
9	Valley Springs Estates	Not Currently in Planning	71
10	Unnamed	Not Currently in Planning	541
11	Red Verde	Foreclosed	91
Buildout Subtotal			945
Total			1,364

- Values reflect future development only (do not include infill)
- Phase I developments on CCPD list

Considering Use of Lower Unit Flow Factor (160 and 195 gpd/ESFU)

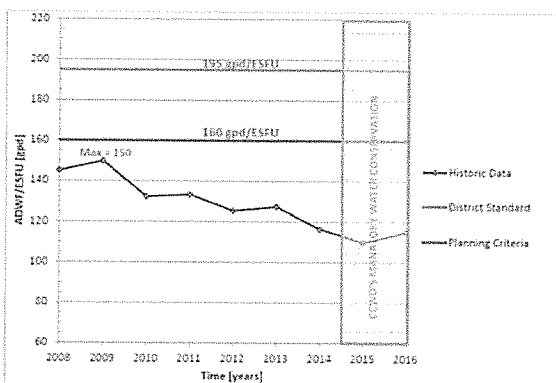

Figure 5. Recommended and Historic Unit ADWF Factors

- ESFUs used to project flows
- Unit Flow Factor
 - 195 District Standard
 - 150 Historic Maximum
- Recommend considering 195 and 160 gpd/ESFU
 - Greater than all historic flow factors reviewed
 - Small cushion (6.7%) above highest historic flow factor

Projected Flows and Loads (160 and 195 gpd//ESFU)

Table 9. Projected Flows and Pollutant Loads

Parameter	Average Dry Weather	Average Annual	Maximum Month	Maximum Day	Peak Wet Weather
Current					
Flow (MGD)	0.14	0.15	0.24	0.44	0.94
BOD ₅ (lbs/day)	na	184	384	520	na
TSS (lbs/day)	na	150	290	385	na
TKN (lb-N/day)	na	77	185	262	na
Phase 1					
Flow (MGD) (160 gpd/ESFU)	0.24	0.26	0.41	0.79	1.23/1.38
Flow (MGD) (195 gpd/ESFU)	0.26	0.29	0.44	0.86	1.24/1.39
BOD ₅ (lbs/day)	na	286	686	972	na
TSS (lbs/day)	na	233	466	629	na
TKN (lb-N/d)	na	121	290	411	na
Buildout					
Flow (MGD) (160 gpd/ESFU)	0.39	0.43	0.67	1.29	2.08/3.20
Flow (MGD) (195 gpd/ESFU)	0.45	0.5	0.77	1.49	2.23/3.45
BOD ₅ (lbs/day)	na	445	1,068	1,513	na
TSS (lbs/day)	na	363	726	980	na
TKN (lb-N/d)	na	187	446	632	na

Regulatory Requirements

- State Water Resources Control Board (SWRCB) Water Quality Order No. 2009-0006-DWQ Notice of Applicability received December 13, 2012
 - *Disinfected Tertiary Recycled Water*
(< 2 NTU and 2.2 MPN/100 mL)
- Treated effluent used to irrigate La Contenta Golf Course (only means of disposal)
- Rated ADWF capacity is 0.20 MGD; Current ADWF is 0.14 MGD (70% of capacity)

Evaluation of Existing Facilities

Sewer Collection System

- Currently serves approximately 707 acres
- At buildout, 1,339 ac to be sewerred
- Approximately 213 ac not sewerred
- 4 Lift Stations
 - 3 Minor - Wood Gate 1 & 2 and Highway 26
 - 1 Major - Huckleberry
- Remaining useful life 20 – 40 years (collection)
- *Next Steps:*
 - *Define future sewersheds and roles*

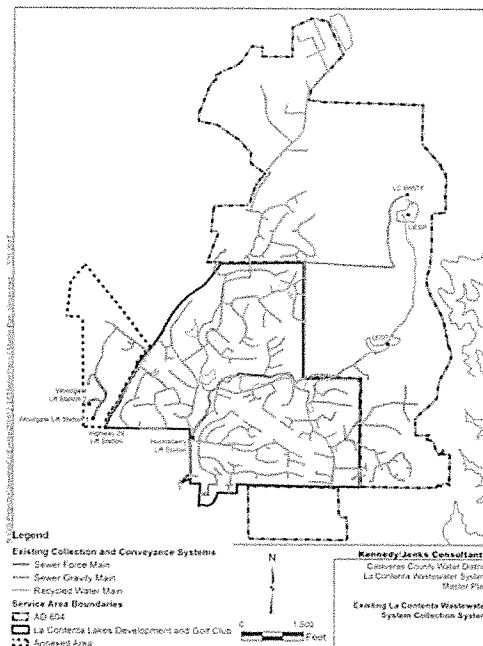

Huckleberry Lift Station

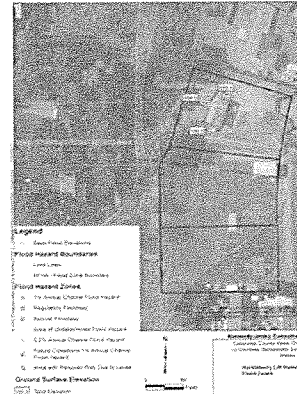
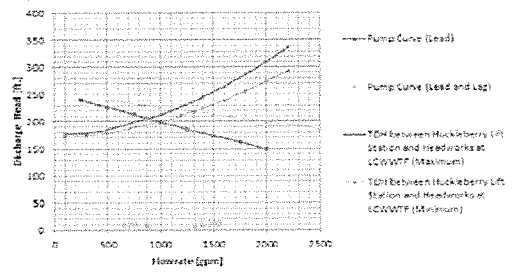

- Huckleberry LS receives all sewage, pumps to LCWWTF
- Pump cycling; LCWWTF pulsing (small wet well, high static lift)
- Located within floodzone – improvement recommended
- Recent measurements indicate 1,140 gpd/acre

13

Wastewater Treatment Facility

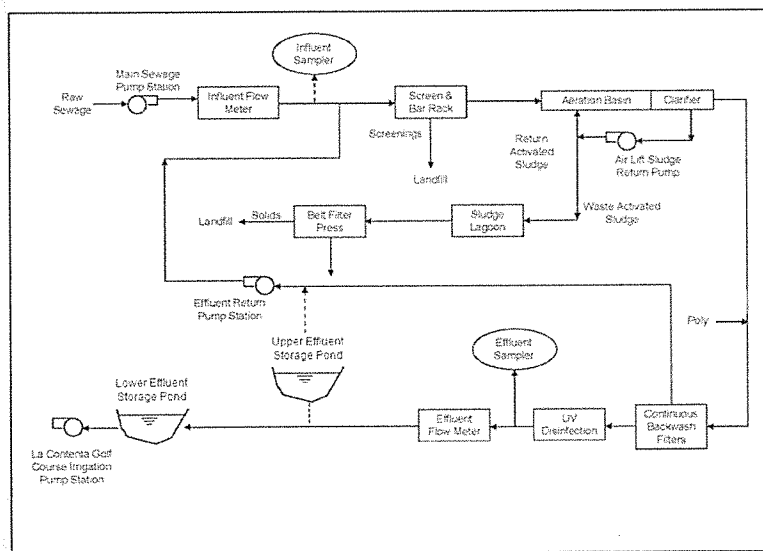

La Contenta Wastewater Treatment Facility Process Flow Schematic

14

Wastewater Treatment Facility

Table 11. LCMWTF Dual Processors: Operating Criteria and Operating Conditions

Facility and/or Unit Process	Dewatering	Operating Criteria or Limits	Units	Operating Conditions, gpm		Based Capacity		Notes
				Current	All Capacity	As Loaded	RRM	
Mucklery (C&G) Lift Station	TBD	Pumping capacity with largest inlet out of service	1 @ 750 gpm (40 HP); 2 @ 750 @ 450 gpm (each); 2 @ 750 @ 450 gpm (each)	655	1,300	100	10 (PWWP)	Based on January 10, 2017 PWWP operating data
		Net wet volume, no more than 10 pump hours/day	Net wet volume between 3,200 and 4,000 gallons. Approximately 1.0 x 4 ft (diameter) of wet well depth	7 m ³ /hr	10 m ³ /hr	70	1.0 (PWWP)	Current operating conditions based on La Contenta Mainline Plan (February 2005) at Capacity flow based on March 3, 2014 Regeneration Consensus Procession
Hydroxide (S&B) Barriers	3	1 MGD	1.8 inch Parkton Aquagard mechanically cleaned bar screen; 1.2 inch mechanically cleaned bar screen; 1.2 inch mechanically cleaned bar screen (Thames)	483.58	974	94	10 (PWWP)	Based on January 10, 2017 PWWP operating data. Requires two bar screens
Hydroxide (S&B) Barriers	4	Hydraulic Retention Time, AOWR 24 to 48 hours recommended	100,000 gallon aeration basin	97.2	17.58	34	0.8	
Parkton Barlow® Integral Clarifier	5	Surface Overflow Rate, AOWR	100,000 gallon integral clarifier	97.2	170.0	70	0.2	
Primary Sludge (Parkton Drystack)	7	Maximum theoretical loading rate (lb/gpd) with one unit out of service (assumed to be equivalent to Maximum Dry Conditions)	1 unit with one unit in continuous backward and forward	200.4	1,000	81	1.4	
UV Disinfection	6	Capacity with 4 modules in standby and 4 in UVT, per Chargeout Summary Results (May 2012)	4 Fluoro UV500 Fluor blocks - 4 modules per bank, 4 lamps per module	91.4	367	24	0.6	Reference capacity described in Electrolytic Disinfection Study for the Project (2008) and Systems of the La Contenta and Upper Effluent WPP (May 2012)
		Capacity with 8 modules in service and 4 in UVT, per Chargeout Summary Results (May 2012)	4 Fluoro UV500 Fluor blocks - 4 modules per bank, 4 lamps per module	422.0	169	41	0.6	
Sludge Storage Lagoon		Hydraulic Retention Time, maximum length	125,000 gallon lagoon, 4 to 10 ft depth	XX days	XX days	XX	XX	
Sludge Filter Area		Feed Rate, gal/acre and operating hours	2 acres Adhesive Laminar Filter 140 ft ² per acre	XX ft ² /min	XX ft ² /min	XX ft ² /min	XX	
Upper Effluent Storage Pond	2	Storage capacity is approximately 400 yr levels of annual precipitation	17.7 acre-ft storage capacity (4,770 acre-inches)	195 acre-ft	151 acre-ft	88	0.21	Based on water balance results reported in Table 1 of the April 9, 2013 Report of Water Budget
		Effluent disposal, at appropriate rates	197 acre-ft per year, average (40,000 and 231,451, 100-yr conditions)	223.0 AFT	223.0 AFT	100	0.20	Limit overall capacity of wastewater system. AOWR to be determined by the total flow for the number of hours results reported in column 7 of the April 9, 2013 Report of Water Budget

Wastewater Treatment Facility

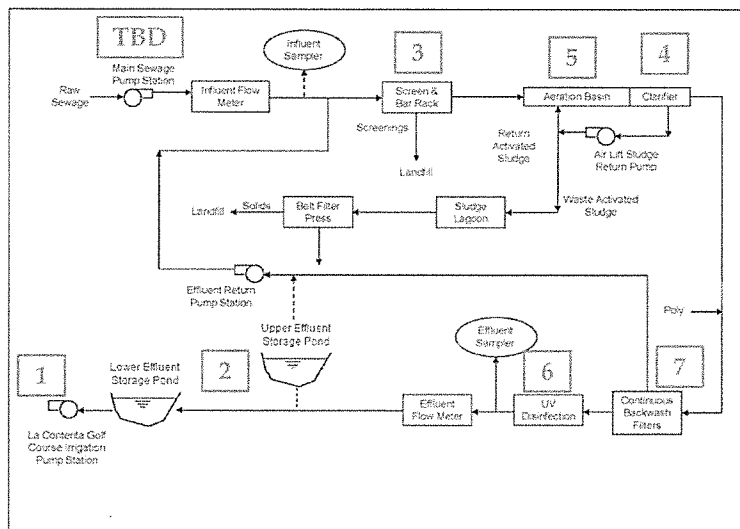

La Contenta Wastewater Treatment Facility Process Flow Schematic

Seasonal Storage & Beneficial Reuse/Disposal

- Upper and Lower Effluent Storage Ponds
 - UESP: 49 AF
 - LESP: 172 AF
- La Contenta Golf Course
 - 70 acres approx.
 - 233 AF per year demand
- Capacity determined by 100-yr level of precipitation water balance

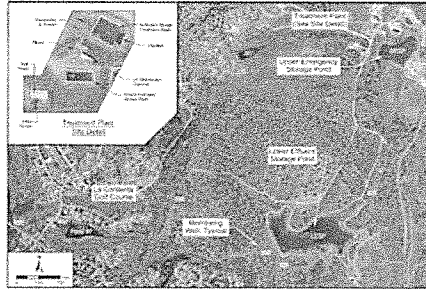

System capacity limited to ADWF of 0.2 MGD by La Contenta Golf Course disposal capacity then seasonal storage

Alternatives, Comparisons and Next Steps

Sewer Collection System

- Describe recommended collection system improvements to serve future developments (developer provided)
- Define future sewersheds and lift stations
- Define Huckleberry Lift Station implications, flood protection and pulsing mitigation improvements
- Compare lift station capacities to future needs

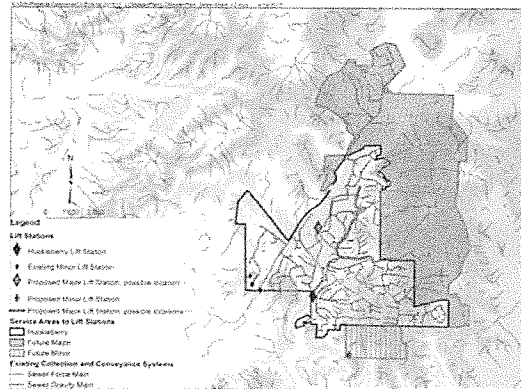

© 19

La Contenta Wastewater Treatment Facility

Phase 1 (Preliminary)

- AquaGuard Bar Screen
- Integral Clarifier
 - Refurbish specific components' – limit time to concrete baffle wall installation
 - Enlarge, reshape and refurbish
 - External circular (cost comparison purposes)
 - Consider running filters in series (not recommended by Parkson)
- Others



* Replace curtain with concrete baffle wall; modify flow introduction & distribution, bottom RAS pumping & skimming, install fillets. Consider competitors to Parkson Biolac™

© 20

La Contenta Wastewater Treatment Facility

Buildout (Preliminary)

- Aeration Basin
 - Existing capacity likely greater than 0.2 MGD
 - Manufacturer updating capacity based on projected flows and loads (incremental capacity increase)
 - Alternatives: Second Biolac train and primary filtration
- UV Disinfection System
- Tertiary Filtration (195 gpd/ESFU)
- Others

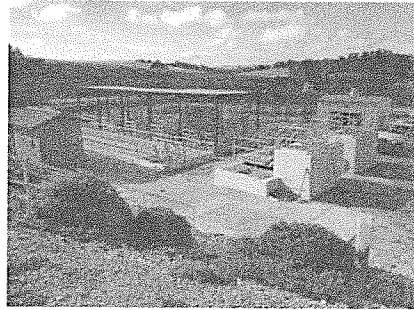

• 21

Seasonal Storage & Beneficial Reuse / Disposal

- Seasonal Storage (Phase 1 Imp. & Buildout)
 - Existing Capacity: 221 AF (41.2 ac watershed and surface area)
 - **Preliminary** Buildout Requirements : 440 AF
 - Represents minimum ideal requirements. Assumes deepen existing; no increase in watershed or surface area
- Treated Effluent Disposal (Phase 1 Imp. & Buildout)
 - Existing Capacity: 233 AFY (70 acres; 3.3 ft/yr rate)
 - **Preliminary** Buildout Requirements: 564 AFY (add 100 acres min.)
 - Same assumptions as above, likely more land required
- Other Combinations of Storage / Disposal Possible

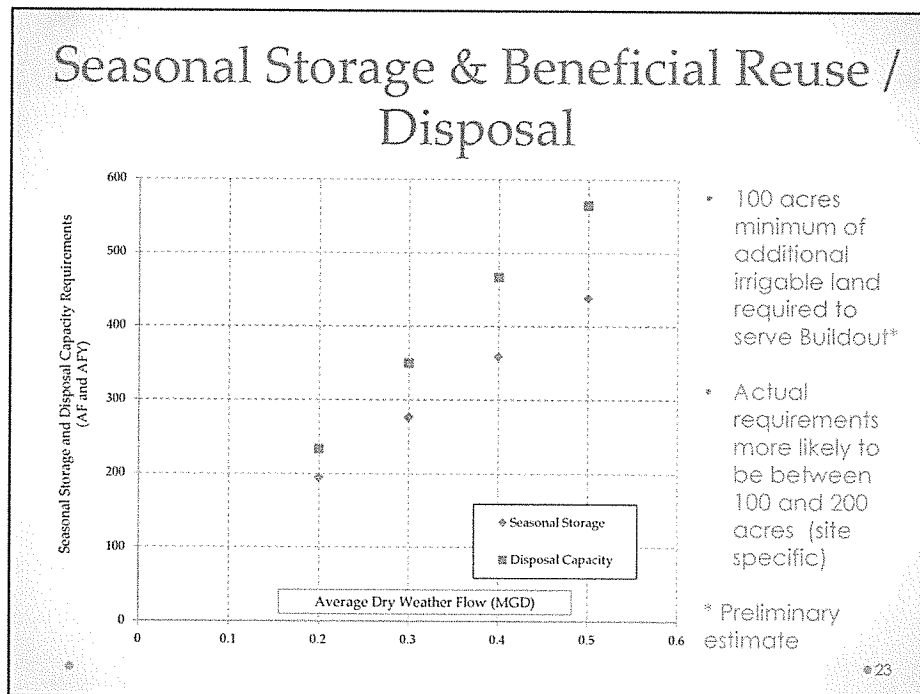

Seasonal Storage & Beneficial Reuse / Disposal

- Several sites for seasonal storage and disposal expansion considered by District in the past
- In addition to land, costs include *environmental* and regulatory compliance, *conveyance*, *containment*, maintenance and ongoing monitoring and reporting
- Land costs \$16,130 per acre
- Land costs likely in the \$2 to 3M range, maybe higher depending on wetlands, etc.

Preliminary Listing of Improvements

1. Treated Effluent Disposal / Beneficial Reuse
2. Seasonal Storage
3. Screen
4. *Huckleberry Lift Station (flood)*
5. Integral Clarifier

6. Aeration Basin
7. UV Disinfection
8. Tertiary Filters
9. Treated Effluent Disposal / Beneficial Reuse
10. Seasonal Storage

© 25

Next Steps

- Incorporate and Address District Input:
- Draft Master Plan: May 31, 2017
- District Review and Comment: June 1 – 14, 2017
- Public Draft Issued: June 28, 2017
- Public Comment Period: July 1-12, 2017
- Final Master Plan: July 19, 2017
- Board Meeting Adoption: July 26, 2017

Questions ??

© 27

OPINION OF PROBABLE CONSTRUCTION COST

KENNEDY/JENKS CONSULTANTS

Client: Calaveras County Water District
 Project: La Contenta Wastewater System
 Location: Calaveras County, CA
 Type: Conceptual

Prepared By: JLH/KK
 Date Prepared: 26-Jul-17
 K/J Proj. No.: 167002100

SUMMARY BY DIVISION

ITEM	ITEM DESCRIPTION		QTY	UNIT PRICE	DIRECT COST TOTAL	MARKUP %	ITEM COST INCLUDING MARKUPS
1A	Huckleberry Lift Station Expansion	LS	1	285,060	285,060	78%	507,407
1B	WWTF -Replace Screen	LS	1	167,500	167,500	78%	298,150
1C	WWTF- Integral Clarifier Improvement	LS	1	507,564	507,564	78%	903,464
1D	WWTF- Activated Sludge Process Train	LS	1	785,440	785,440	78%	1,398,083
1E	WWTF - UV Disinfection Improvements	LS	1	61,250	61,250	78%	109,025
1L	Seasonal Storage and Disposal - Land	ACRES	130	16,500	2,145,000	78%	2,145,000
	Sprayfield Systems	ACRES	60	5,000	300,000	78%	300,000
PHASE 1 CONSTRUCTION SUBTOTAL					1,828,314		5,661,129
	Design Engineering					10%	566,113
	Legal/ Administration					5%	283,056
	Construction Management					10%	566,113
PHASE 1 PROJECT SUBTOTAL							7,380,090

ITEM	ITEM DESCRIPTION		QTY	UNIT PRICE	DIRECT COST TOTAL	MARKUP %	ITEM COST INCLUDING MARKUPS
2B	WWTF - Additional Screen & Washer Compactor	LS	1	300,000	300,000	78%	534,000
2C	WWTF- Activated Sludge Process Train	LS	1	660,920	660,920	78%	1,176,438
2F	WWTP - New Clarifier Addition	LS	1	864,500	864,500	78%	1,538,810
2G	WWTF - Tertiary Filters	LS	1	149,702	149,702	78%	266,470
2L	Seasonal Storage and Disposal - Land Cost Only	ACRES	60	16,500	990,000	78%	990,000
	Sprayfield Systems	ACRES	60	5,000	300,000	78%	300,000
PHASE 2 CONSTRUCTION SUBTOTAL					1,996,622		4,805,718
	Design Engineering					10%	480,572
	Legal/ Administration					5%	240,286
	Construction Management					10%	480,572
PHASE 2 PROJECT SUBTOTAL							6,010,090

The following markups have been allocated to each bid item:

- Site Overhead/ General Conditions 10%
- Design/Estimating Contingency 30% 1.78
- Escalate to Midpt of Const. @ 6% (3% per year / 24 months out)
- Bonds & Insurance 2%
- Contractors Fee @ 15%

Ph 1
Ph 2

* Escalation for Buildout beyond Phase 1 is not included.

Estimate Accuracy	
+50%	-30%

Phase 1

Estimated Range of Probable Cost		
+50%	Total Est.	-30%
\$11,070,000	\$7,380,000	\$5,166,000

OPINION OF PROBABLE CONSTRUCTION COST

Client: Calaveras County Water District
 Project: La Contenta Wastewater System
 Location: La Contenta Wastewater System
 Estimate Type: La Contenta Wastewater System

KENNEDYJENKINS CONSULTANTS

Prepared By: JH
 Date Prepared: 31-Jul-17
 K/J Proj. No. 1670021-00

CSI Spec. Division	Qty	Unit	Description	Materials		Labor		Equipment		Subcontractor		Total	Source
				Material	Unit	Rate	Cost	Rate	Cost	Rate	Cost		
3	4,480	VBF	Flood Wall					24.00	107,520			107,520	
3	560	LF	Flood Wall Footing					50.00	28,000			28,000	
3	1	LS	Concrete Rehabilitation							25,000		25,000	
2	3	EA	Demo Existing Pumps					500.00	1,500			1,500	
2	1	LS	Demo Existing Slide Rail					500.00	500			500	
40	1	EA	Piping modifications at Flow Meter										
40	2	EA	12x6 Reducers										
40	1	EA	Influent Pipe Modifications										
40	1	LS	SCADA Programming Modification							5,000		5,000	
43	1	LS	Grinder Rail System										
43	10,000.00	EA	Grinder										
43	1	EA	Jockey Pump 150-190 gpm										
43	2	EA	Replacement Sump Pumps 905/										
43	1	EA	Electrical Work for Above										
Grand Total										28,740		28,740	

Blot clean - spot repairs only
 in existing vault
 assumes existing power is sufficient

OPINION OF PROBABLE CONSTRUCTION COST

Client: Colveras County Water District
 Project: La Comenda Wastewater System
 Location: _____
 Estimate Type: Conceptual

KENNEDY/JENKS CONSULTANTS

Prepared By: JLH
 Date Prepared: 31-Jul-17
 K/J Proj. No. 1670021'00

Alloc. Method	CSI Spec. Division	Description	Qty	Units	Materials	MP	Labor	Equipment	Subcontractors	Services	Total	
											Estimate	Estimate
	26	Demo Existing Screen	1	LS	2,500.00		5,000.00				7,500	
	46	Disconnect/Reconnect Electrical	1	LS			30,000.00		10,000		40,000	
		Influent Screen Replacement 1.5	1	EA	120,000.00		30,000.00				150,000	
	Grand Total										167,500	

assumes existing power supply is
 Parkson Aquaguard

OPINION OF PROBABLE CONSTRUCTION COST

Client: Calaveras County Water District
 Project: La Contenta Wastewater System
 Location: _____
 Estimate Type: Preliminary

KENNEDYJENKS CONSULTANTS

Prepared By: JLH
 Date Prepared: 31-Jul-17
 KJ Proj. No. 1670021'00

Item #	Qty	Description	Unit	Material	Labor	Equipment	Subcontractors		Source
							Amount	Total	
2	1	Demo existing curtain wall	LS						5,000.00
2	1	Demo RAS Airift System	LS						2,500.00
2	1	Demo Skimmer	LS						5,000.00
3	22	Concrete Baffle Wall	CY	350.00	7,562				5,000.00
3	50	Concrete Baffle Wall Footing	LF						17,283.63
	1	RAS Flow Automation including: Influent Flow Meter 12" RAS Pump Submersible RAS Flow Meter RAS Flow Meter PLC	LS	220,000.00	220,000.00	1,000.00	50		2,160.00
	1	WAS Flow Meter	EA	5,000.00	2,000.00	2,000.00			2,500.00
	1	TSS Meter	EA	10,000.00	2,500.00	2,000.00			5,000.00
	1	Electrical I&C for Flow Automation	LS	10,000.00	2,500.00	2,000.00			2,000.00
	1	Existing Clarifier Internals including: Skimmer Replacement WAS Piping Modifications 4" Actuated WJAS Valve	EA	51,000.00	15,000.00				7,000.00
	1	6 x 4 Reducers	EA	1,000.00	800.00				15,000.00
	2	Electrical I&C for Existing Clarifier Internals	EA	500.00	200.00				500.00
	1		LS		31,482				1,650.00
									51,180

OPINION OF PROBABLE CONSTRUCTION COST

Client: Calaveras County Water District
 Project: La Contenta Wastewater System
 Location: La Contenta Wastewater System

KENNEDY/JENKS CONSULTANTS

Prepared By: J.L.H.
 Date Prepared: 31-Jul-17
 K/J Proj. No. 1670021-00

Estimate Type: Preliminary

WBS/BBB	CFR/Spec/Division	Description	Qty	Unit	Materials		Installation		Equipment		Subcontractor		Notes
					Amount	Total	Amount	Total	Amount	Total	Amount	Total	
2		Remove Existing Aeration Equipment in Bas	1	LS		2,000.00	1,000.00	3,000.00				74,000	
3		Add Equipment Pads for Blowers	1	EA	1,000.00	1,000.00		3,000.00				6,000	
43		Phase 1/Basin 1/Biolec System Inck	1	LS	458,000.00	458,000.00		3,000.00				458,000	
43		Aeration Moving Chain Uplift	7	EA			5,720.00	56,508				53,000	
		Electric Act Valves	7	EA			5,000.00	37,500				26,000	
		Blowers Assemblies (25 HP)	3	EA			5,000.00	15,000				5,000	
		12" Influent Flowmeter	1	EA			4,000.00	4,000				4,000	
		Submersible RAS Pump	1	EA			2,500.00	2,500				2,500	
		RAS Flowmeter	1	EA			2,500.00	2,500				2,500	
		DO Probe and Analyzer	1	EA			2,500.00	2,500				2,500	
		Control System	1	EA			2,500.00	2,500				2,500	
		Electrical & I&C for Above	1	EA								11,000	
												32,000	
												252,000	
		Grand Total										91,600	
												99,840	

OPINION OF PROBABLE CONSTRUCTION COST

Client: Calaveras County Water District
 Project: La Conte's Wastewater System
 Location: _____
 Estimate Type: Preliminary

KENNEDY/JENKS CONSULTANTS

Prepared By: JLH
 Date Prepared: 31-Jul-17
 K/J Proj. No. 1670021'00

Item #	CSI Spec. / Description	Qty	Unit	Market Price	MTL Unit	MTL Price	Material Labor	Subcontract	Equipment	Subcontract	Field	Sample
43	UV Disinfection - Open Channel	1	LS	49,000.00	1	49,000.00	32,250.00				61,250	CHC Water Trojan
Grand Total												

OPINION OF PROBABLE CONSTRUCTION COST

Client: Calaveras County Water District
 Project: La Conte's Wastewater System

KENNEDY/JENKS CONSULTANTS

Prepared By: JH
 Date Prepared: 31-Jul-17
 K/J Proj. No. 1670021-00

Estimate Type: Preliminary

Swp/Blk	CSI Spec	Durable	Description	Qty	Unit	Materials		MIP Unit	Labor		Equipment	Sub-contractor		Source
						Estim	Total		Estim	Total		Estim	Total	
46			Influent Screen Replacement 1.5	1	EA	120,000.00	120,000.00		32,000.00	32,000.00				Parkson Aquaguard
46			Washer/Compactor	2	EA	40,000.00	80,000.00		30,000.00	60,000.00		50,000	50,000	Parkson Aquaguard
46			Electrical/IBC Allowance	1	EA		50,000.00							20% of total
Grand Total												50,000	50,000	300,000

OPINION OF PROBABLE CONSTRUCTION COST

Client: Calaveras County Water District
 Project: La Contencia Wastewater System
 Location: _____

Estimate Type: Preliminary

KENNEDY/JENKS CONSULTANTS

Prepared By: JH
 Date Prepared: 31-Jul-17
 KJ Proj. No. 1670021*00

Asset / Bid	CSI System Division	Description	Qty	Unit	Miscellaneous		WHI / Bids / RFFS		Labor		Interference		Equipment	Subcontractors		Sponsor
					Amount	Total	Amount	Total	Rate	Amount	Rate	Amount		Rate	Amount	
31		Construct Basin 2 (Excavation, Grading, Phase 2 / Basin 2 Biolac System Incl: Aeration Moving Chain Units	1	LS	95,000.00	95,000.00		257,000.00			318,000.00	185,000.00				200,000.00
43		Electric Act Valves	7	LS	257,000.00	51,400.00					51,400.00					200,000.00
		Blowers Assemblies (40HP)	3													
		12" Influent Flowmeter	1													
		Submersible RAS Pump	2													
		RAS Flowmeter	2													
		DO Probe and Analyzer	2													
		Air Control Valves	2													
		Control System	1													
		Yard Piping	1	LS												50,000.00
		Electrical & I&C	1	LS												101,600.00
		Grand Total														666,920.00
																10% of Total
																20% of Total

OPINION OF PROBABLE CONSTRUCTION COST

Client: Colavacas County Water District
 Project: La Contenta Wastewater System
 Location: _____

KENNEDY/JENKS CONSULTANTS

Prepared By: JH
 Date Prepared: 31-Jul-17
 K/J Proj. No. 1670021-00

Estimate Type: Preliminary

Item No.	Est. Spec. Division	Description	Qty	Units	Materials		MHI	Mechanical		Equipment	Sub-contractor		Total	Source
					Material	Subtotal		Subtotal	Subtotal		Subtotal	Subtotal		
2		Demo Existing Clarifier	1	EA										
3		36 dia Svc Clarifier 21' sidewall d/c	1	EA	375,000.00	375,000.00								
40		Yard Piping	1	LS										
40		Electrical / I&C	1	LS										
Grand Total														
											65,500	10% of total		
											133,000	20% of total		
											233,000	100% of total		

OPINION OF PROBABLE CONSTRUCTION COST

Client: Calaveras County Water District
 Project: La Contenda Wastewater System
 Location: _____
 Estimate Type: Preliminary

KENNEDY/JENKS CONSULTANTS

Prepared By: JJJH
 Date Prepared: 31-Jul-17
 KJ Proj. No. 1670021-00

Est. Item Description	Qty	Unit	Material	Material		Labor	Labor		Equipment	Subcontractor		Total	Source
				Price	Total		Rate	Total		Rate	Total		
Excavation	180	CY	5,000.00	900,000.00	3,500	630,000.00	3,500	12,250.00			3,500	12,250.00	
Shoring	1,188	VSF	5.00	5,940.00	30,000	356,400.00	30,000	900.00			30,000	900.00	
Concrete Base Slab	7	CY	250.00	1,750.00	1,815	12,705.00	1,815	7,380.00			1,815	7,380.00	
Concrete Tank Walls	31	CY	300.00	9,300.00	9,333	281,311.00	9,333	281,311.00			9,333	281,311.00	
Railing	42	LF	50.00	2,100.00	2,150	107,500.00	2,150	86,000.00			2,150	86,000.00	
Grating	98	SF	50.00	4,900.00	4,000	200,000.00	4,000	160,000.00			4,000	160,000.00	
Tertiary Sand Filter	40	Ea	51,250.00	2,050,000.00	12,013	624,522.00	12,013	624,522.00			12,013	624,522.00	Parkson Dynamand May 2017 Proj
Interconnection Piping	40	LS	5,000.00	200,000.00	5,000	250,000.00	5,000	250,000.00			5,000	250,000.00	
Electrical / I&C	40	LS	5,000.00	200,000.00	5,000	250,000.00	5,000	250,000.00			5,000	250,000.00	
Grand Total											14,813		20% of Total

KENNEDY/JENKS CONSULTANTS
OPINION OF PROBABLE CONSTRUCTION COST

BASIS OF ESTIMATE

PROJECT INFORMATION

Client: Calaveras County Water District
Project: La Contenta Wastewater System
KJ Job No.: =' Detailed Estimate'IT4
Estimate Date: 7/31/2017
Prepared By: JLH
Reviewed By: KK
Estimate Type: Conceptual
ACEI Class Level Estimate : 5

PROJECT DESCRIPTION:

The scope of work for this project includes:

ESTIMATE DOCUMENTS:

DRAWINGS:

DOCUMENTS: Wastewater System Master Plan

COSTS PROVIDED BY OTHERS:

SOURCE OF COST DATA:

ESTIMATE ASSUMPTIONS:

The followings assumptions were made in the preparation of this estimate:

SPECIFIC INCLUSIONS:

SPECIFIC EXCLUSIONS:

The estimate does not include the following:

MAJOR CHANGES FROM PREVIOUS ESTIMATE:

DESIGN CONTINGENCY:

A design contingency of 30 % has been included.

Note: This allowance is intended to provide a Design Contingency allowance. It is not intended to provide for a Construction Contingency for change orders during construction or to cover unforeseen conditions.

ESCALATION:

An escalation factor has been included to account for a midpoint of construction in approximately ____, 20__. The owner is cautioned that the project cost should be adjusted for any changes in the project schedule.

Current ENR CCI	Aug-16	10385	
Annual Inflation Escalation Factor:		3%	
Time Until Project Midpoint (Months)		24	Number of months

ACCURACY:

The level of accuracy is commensurate with levels developed by the AACE, the Association for the Advancement of Cost Engineering International. At increasing levels of design completion, the narrower the range between upper and lower limits and the greater the accuracy of the estimate. This estimate is considered a Class 5 level estimate in accordance with AACE guidelines. Typically this level of estimate has an expected accuracy range of +50%/-30%. This estimate is based upon competitive bidding, which assumes receipt of multiple bids from five or more General Contractors. Without competitive bidding, pricing can vary significantly from the prices assumed in this estimate.

The enclosed Engineer's Estimate of Probable Construction Cost is only an opinion of possible items that maybe considered for budgeting purposes. This Project Estimate is limited to the conditions existing at issuance and is not a guaranty of actual construction cost or schedule. Uncertain market conditions such as, but not limited to, local labor or contractor availability, wages, other work, material market fluctuations, price escalations, force majeure events and developing bidding conditions, etc. may affect the accuracy of this review. Kennedy/Jenks is not responsible for any variance from this Project Estimate or actual prices and conditions obtained.

ENGINEER'S ESTIMATE OF PROBABLE COST

Project: McKinleyville CSD Wastewater Management Facility Improvements

Building, Area: Aeration Basins MODIFIED QTY FOR SMALLER SIZE and QTY 1 for LA CONTENTDA

KENNEDY/JENKS CONSULTANTS

Prepared By: WMH
 Date Prepared: 8-Dec-14
 K/J Proj. No. 1368004.00

Estimate Type: Conceptual Preliminary (w/o plans) Design Development @ 100 % Complete

Current at ENR

Escalated to ENR

Spec. Section	Item No.	Description	Qty	Units	Materials		Installation		Sub-contractor		Total
					\$/Unit	Total	\$/Unit	Total	\$/Unit	Total	
Div 2		Excavate	3,293	CY		0	10.00	32,933			32,933
		Place & Compact exc material	3,293	CY			10.00	32,933			32,933
		Grading	15,950	SF			2.00	31,900			31,900
		60 mil HDPE Liner (1 layer)	19,439	SF		1.00	0.25	4,860			24,298
		Safety ladders	4	EA		300.00	60.00	238			1,426
		Safety ropes	4	EA		100.00	20.00	79			475
		Life rings	2	EA		800.00	160.00	370			2,218
		Pipe Boots	3	EA		200.00	50.00	150			750
		Floating Header Anchor Bollards	16	EA		890.00	88.50	1,374			15,186
Div 9		Coatings on Piping and Equipment	1	LS		1,500.00	750.00	750			2,250
Div 11		Aeration System	1	LS		0	0.00	0			0
Div 15		Piping									
		20" ML	20	LF		57.00	25.90	518			1,658
		1" A	40	LF		11.55	2.51	100			562
		4" A - SS	110	LF		31.50	21.07	2,318			5,783
		Pipe Saddle Supports-4" w/ conc base	15	EA		150.00	75.00	1,089			3,267
		Fittings									
		1" 90 deg EI	8	EA		5.40	5.60	45			88
		1" Ball Valve	2	EA		250.00	50.00	100			600
		4" 90 deg EI - SS fxf	7	EA		394.50	702.50	5,100			7,964
		4" spool - SS fxf	7	EA		355.50	749.50	5,441			8,022
		4" spool - SS fype	7	EA		256.50	438.50	3,184			5,046
		10" X 10" X 4" Tee DI	8	EA		1,075.00	201.00	1,592			10,106
		20" 90 deg EI	2	EA		4,050.00	404.50	809			8,909
		20" Bell Mouth	2	EA		4,687.00	412.00	824			10,198
		20" Tee	2	EA		6,825.00	606.00	1,212			14,862
		1-1/4" Utility Station	2	EA		700.00	210.00	420			1,820
Subtotals							94,917	128,338			223,255

ENGINEER'S ESTIMATE OF PROBABLE COST

Project: McKinleyville CSD Wastewater Management Facility Improvements

Building, Area: Secondary Clarifiers

KENNEDY/JENKS CONSULTANTS

Prepared By: WMH/JLH
 Date Prepared: 8-Dec-14
 K/J Proj. No. 1368004.00

Current at ENR
 Escalated to ENR

Estimate Type: Conceptual Preliminary (w/o plans)
 Design Development @ 100 % Complete
 Construction Change Order

Spec. Section	Item No.	Description	Qty	Units	\$/Unit	Materials Total	Installation \$/Unit	Installation Total	Sub-contractor \$/Unit	Sub-contractor Total	Total
Div 2		Dewatering	2	LS			10,000.00	20,000			20,000
		Excavation	2,814	CY			6.99	19,670			19,670
		Imported Structural Fill	324	CY	18.00	5,832	1.85	599			6,431
		Crushed Base	538	CY	25.00	13,444	5.00	2,689			16,133
		Native Backfill	1,573	CY			2.04	3,209			3,209
		Compaction	2,435	CY			1.74	4,237			4,237
		Manhole (4' Dia, 12 feet deep)	1	EA	1,845.00	1,845	1,283.00	1,283			3,128
		Protective Bollards	9	EA	890.00	8,010	88.50	797			8,807
Div 3		Concrete Slab - Center	5	CY	227.00	1,235	200.00	1,089			2,324
		Concrete Base Slab	460	CY	227.00	104,336	131.00	60,211			164,547
		Concrete Encase RAS Pipe	9	CY	227.00	2,053	131.00	1,185			3,237
		Concrete Tank Walls	329	CY	288.00	94,883	353.00	116,298			211,181
		Box Concrete Tank Walls	41	CY	418.00	16,986	422.00	17,148			34,134
		Elevated Concrete Slab- Effi Weir	18	CY	348.00	6,234	1,218.00	21,820			28,054
		Conc equipment Pad between clarifiers	27	CY	220.00	5,867	125.00	3,333			9,200
		Sidewalks	27	CY	200.00	5,318	125.00	3,324			8,642
		Grout Bottom	3,925	SF	0.62	2,434	1.47	5,770			8,203
		Grout Fill SE Box	7	CY	200.00	1,368	120.00	821			2,188
Div 5		Metal Grating	48	SF	29.70	1,426	14.30	686			2,112
		Aluminum Handrail	327	EA	72.60	23,708	37.40	12,213			35,922
		Davit Bases	2	EA	500.00	1,000	100.00	200			1,200
		Access Hatches	1	EA	2,356.00	2,356	1,178.00	1,178			3,534
Div 9		Coatings on Piping and Equipment	1	LS	5,000.00	5,000	2,500.00	2,500			7,500
Div 11		Clarifier Equipment									
		New 50' Clarifier Drive Mechanism	2	EA	120,000.00	240,000	28,020.00	56,040			296,040
		Effluent Weir Plates & Scum Baffle	2	EA	10,000.00	20,000	24,352.00	48,704			68,704
		Stamford Baffles	2	EA	16,000.00	32,000	4,800.00	9,600			41,600
		6" Sluice Gates	2	EA	2,900.00	5,800	594.00	1,188			6,988

Spec. Section	Item No.	Description	Qty	Units	Materials		Installation		Sub-contractor Total	Total
					\$/Unit	Total	\$/Unit	Total		
		18" X 24" Slide Gates	2	EA	5,475.00	10,950	630.00	1,260		12,210
		RAS Pumps	4	EA	10,753.00	43,012	2,150.60	8,602		51,614
		WAS Pump	1	EA	16,500.00	16,500	4,950.00	4,950		21,450
		Spare WAS Pump	1	EA	16,500.00	16,500				16,500
		Scum Pump	1	EA	5,500.00	5,500	1,100.00	1,100		6,600
		Spare Scum Pump	1	EA	5,500.00	5,500				5,500
		Life Rings	2	EA	800.00	1,600	160.00	320		1,920
Div 15		Piping								
		4" SC	59	LF	14.55	858	11.26	664		1,523
		4" WAS	32	LF	14.55	466	11.26	360		826
		6" RAS	126	LF	16.85	2,123	6.76	852		2,975
		8" RAS	60	LF	23.50	1,410	11.56	694		2,104
		20" ML	52	LF	57.00	2,964	25.90	1,347		4,311
		Fittings								
		4" 90 deg El	6	EA	258.00	1,548	86.50	519		2,067
		4" Flexible Coupling	8	EA	35.50	284	43.50	348		632
		6" Tee	2	EA	630.00	1,260	163.00	326		1,586
		6" 90 deg El	6	EA	385.00	2,310	108.00	648		2,958
		6" X 8" Increaser	2	EA	525.00	1,050	123.00	246		1,296
		8" 90 deg El	6	EA	725.00	4,350	134.00	804		5,154
		8" X 12" Increaser	1	EA	795.00	795	182.00	182		977
		20" 90 deg El	2	EA	4,050.00	8,100	404.50	809		8,909
		Valves								
		4" Check Valve	2	EA	1,200.00	2,400	268.00	536		2,936
		4" Plug Valve	4	EA	470.00	1,880	268.00	1,072		2,952
		6" Check Valve	4	EA	1,050.00	4,200	430.00	1,720		5,920
		6" Plug Valve	2	EA	1,785.00	3,570	404.00	808		4,378
		8" Plug Valve	2	EA	2,375.00	4,750	537.50	1,075		5,825
		1-1/4" Utility Station	4	EA	700.00	2,800	210.00	840		3,640
Div 17		4" MAG Flow Meter	1	EA	2,300.00	2,300	230.00	230		2,530
		6" MAG Flow Meter	2	EA	3,300.00	6,600	330.00	660		7,260
Subtotals					756,714	446,763				1,203,478
					378,357	223,382				

Cost Estimate Request

Date Required _____ Budgeted Hrs: _____
Project No. _____ PH _____ TASK: _____
Org: _____ (Janet's org is 1098)

Site Address: _____

Information Available: Drawings _____
Specs _____
Asbuilts _____
Photos _____
Previous Estimates _____
Vendor Information _____

File Server Location: _____

Estimate Type: Preliminary
Alternatives Analysis
Routing Study
Lifecycle

Estimate Format: Standard KJ or Client Specific?
By Area, By Division, By Building ?
Is there potential for project to be seperated into phases?
Add Alternates?

Expected Construction Start Date:

Design Team Members by Disipline: Process/ Mech _____
Civil _____
Structural _____
Architectural _____
Electrical _____
Controls _____

Will design discliplines or subconsultants be providing input to estimate?

Speciality items or vendor quotes that should be requested?

Are there any confidentially concerns with project?

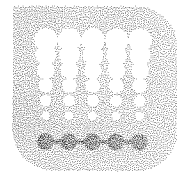
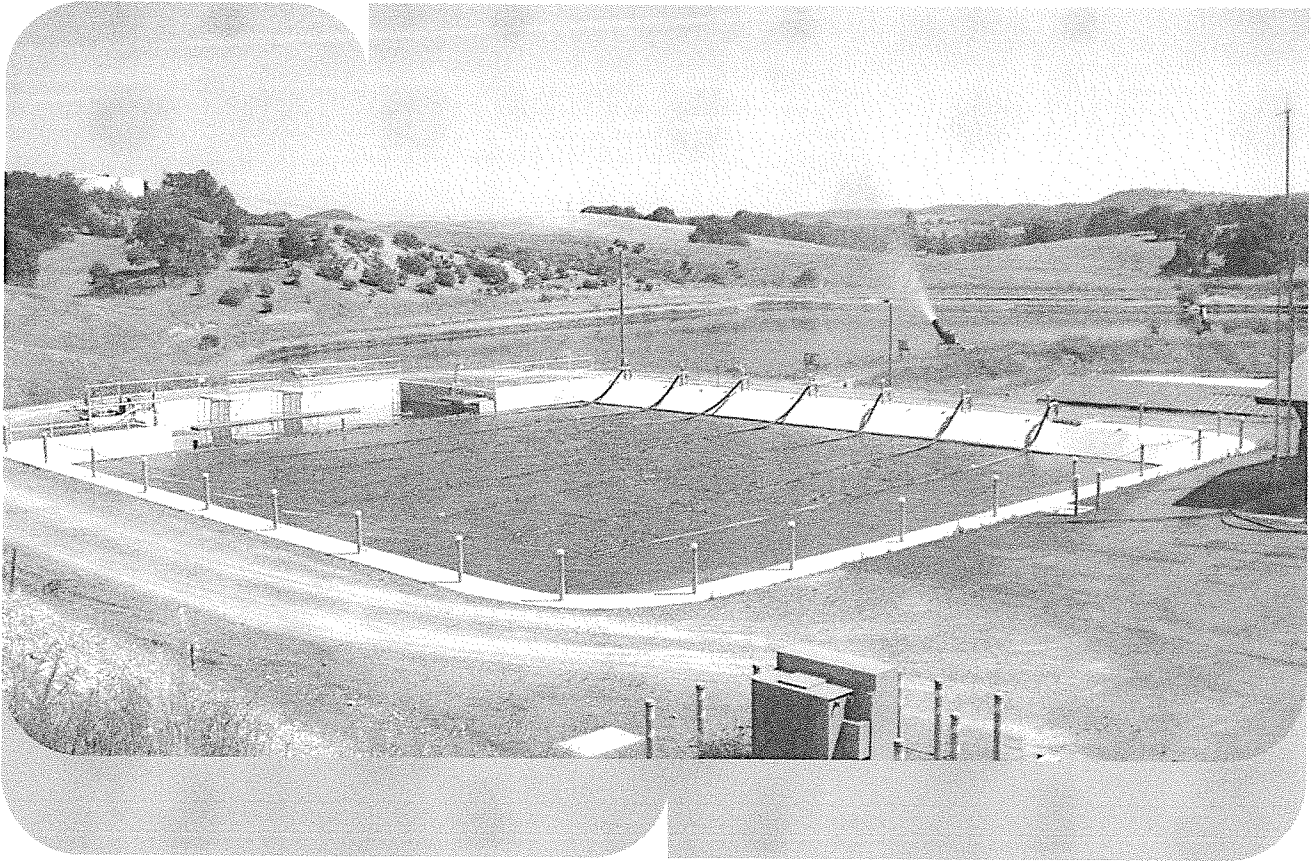

biolac®

La Contenta, CA
Preliminary Design Proposal
June 15, 2017



Preliminary Design Proposal



To:	Kevin Kennedy; Chantelle Garvin	Date:	6/15/2017
Company:	Kennedy/Jenks Consultants	From:	Rakesh Desai
Tel.:	(916) 858-2700	Tel.:	(954) 917-1818
cc:	Mark Rasor, Steve Young, John Deogracias, Dean Boode (Coombs-Hopkins)		
Subject:	Parkson Biolac® Treatment System, Preliminary Design Proposal for La Contenta, CA - Upgrade		

Dear Mr. Kennedy/ Ms. Garvin,

Thank you for your interest in Parkson's Biolac® Treatment System. Based upon the data provided for this project, we developed the Biolac® design described in this proposal. We believe that this Biolac® design not only meets effluent quality requirements, but also provides the most cost effective solution for this municipality.

We look forward to working with you on this project. Should you have any questions or need clarifications, please do not hesitate to contact me at (954) 917-1818. Thanks.

Sincerely,

PARKSON CORPORATION

An Axel Johnson, Inc. Company

Rakesh Desai
Sr. Applications Engineer
RDesai@Parkson.com



Table of Content

- 1. Design Basis 4
 - 1.1. Influent and Effluent Specifications 4
 - 1.2. Selected Design Parameters 5
- 2. System Description 6
- 3. System Components 8
 - 3.1. Moving Aeration Chain System 8
 - 3.2. Diffuser Frame 9
 - 3.3. System Integral Clarifier 9
 - 3.4. Aeration Design 10
 - 3.5. Clarifier Design 10
- 4. Wave-Ox™ Biological Nutrient Removal 11
- 5. Biolac® Treatment System Preliminary Design Information 12
- 6. Equipment and Services Supplied 13
- 7. Cost Estimate and Term 16
- 8. Supplemental Information and References 16



1. Design Basis

1.1. Influent and Effluent Specifications

The proposed system design is based on wastewater influent with the following characteristics:

Table 1.1 – Design Influent flow requirements

PARAMETER	UNITS	AVERAGE	
Start-Up Flow	MGD	0.24	
		Phase 1	Buildout
Ave Daily Flow	MGD	0.29	0.5
Max Month Flow– Design Flow	MGD	0.44	0.77
Peak Flow	MGD	1.24	2.23

Note: Customer must confirm these final design flows to assure accuracy of the hydraulic calculations.

Table 1.2 - Influent Water Quality

PARAMETER	UNITS	AVERAGE	
Design Temperature	Deg C	20	
Minimum Temperature	Deg C	10	
		Phase 1	Buildout
BOD ₅	lbs/day	686	1,068
Total Suspended Solids	lbs/day	466	726
TKN	lbs/day	290	446
NH ₃ -N	mg/L	60	
Total Phosphorous (TP)	mg/L	6	
pH	-	6 to 9	
Alkalinity	mg/L as CaCO ₃	625	550

Note: Customer must confirm Influent loading conditions for any associated process warranty.

In order to offer this proposal, Parkson Corporation must make the following assumptions. Deviations from these assumptions should be brought to the attention of the designer of this system as modifications maybe required:



- a. The wastewater will be pretreated to remove debris and grit using a fine influent screen.
- b. Sufficient alkalinity is present or will be added to allow nitrification to proceed uninhibited.
- c. The incoming oil, grease, chemical and metals concentrations are within biologically treatable levels.
- d. Sufficient nutrients (P, N, etc.) are present in the influent for biomass growth or will be added by the plant operating staff.
- e. A qualified operator will supervise plant activities and performance.

Based on the specified influent water quality, Parkson anticipates that the proposed Biolac® system will provide the following effluent quality:

Table 1.3 - Effluent Water Quality

PARAMETER	UNITS	QUALITY
BOD ₅	mg/L	10
Total Suspended Solids	mg/L	15
NH ₃ -N	mg/L	1
Total Nitrogen (TN)	Mg/L	8

1.2. Selected Design Parameters

Based on the design loading information described above, the proposed Biolac® System will be derived as follows:

F/M Ratio	0.05-0.06	MLSS	3000 mg/l
SRT	30-70 days	Plant Elevation (above sea level)	750 ft



2. System Description

The Biolac® Biological Nutrient Removal System is an innovative complete mix activated sludge process using extended retention of biological solids to create an extremely stable and easily operated system. The Biolac® process can be applied to a wide range of wastewater treatment applications, whether for municipal application or industrial application. Biolac® has over 800 installations in North American and over 1000 installations globally.

Some of the advantages of the Biolac® BNR process include:

- a. Economical construction: Most Biolac® systems are installed in earthen basins which reduces construction cost tremendously by eliminating the need for sophisticated concrete structures and complex piping systems for recycling.
- b. Biolac® BNR systems are typically designed with a sludge age greater than 30 days. The extended sludge age provides stable operation, low sludge production, low production of well stabilized biosolids, and high effluent quality.
- c. Economical process in terms of operation and maintenance cost.
- d. Comprehensive electrical control system to optimize air delivery and provide peace of mind to plant operator.
- e. Utilization of fine bubble aeration using extremely high mixing efficiency of 4 CFM per 1000 ft³ which is over 50% improvement in comparison to the mixing efficiency achieved by stationary fine bubble diffusers.
- f. Ease of aeration expansion capability simply by adding additional Biofuser® tubes to modules.
- g. Biological nutrient removal is implemented using the Wave-Ox™ design by Parkson's process experts. The Wave-Ox™ process is designed to achieve sequential nitrification / denitrification which results in oxygen and alkalinity recovery and translates into an energy efficient and stable operation.
- h. Integral clarifier design using common walls with the Biolac® basin, designed to make the most efficient use of the available footprint.



- i. Elimination of the need to drain the aeration basin(s) with the Biolac® system since all components can be cleaned and maintained from the surface.

The Biolac® process is characterized by excellent BOD removal, complete nitrification, enhanced denitrification, and biosolids stabilization. It uses fine bubble membrane diffusers attached to floating aeration chains, which are moved across the basin propelled by the air release from the diffusers. The moving aeration chains equipped with the Biofuser® diffuser assemblies provide efficient mixing of the basin contents as well as high oxygen transfer at low energy usage.

The Biofuser® system does not have submerged aeration piping or any other components to be installed, leveled, or secured on the basin floor. The BioFlex® chains with BioFusers do not contact or harm the basin liner. Each BioFlex® chain can be individually controlled by independent air valve providing excellent flexibility in fine-tuning the system to meet the oxygen demand. The individual control capability of the BioFlex chains is used to create alternating oxic and anoxic zones (Wave-Ox™) to allow denitrification in a single basin without internal mixed liquor recycle or complex controls. The moving aeration chain design is not mixing limited so the horsepower required for mixing is typically half of that required for aeration. A turndown capability of 50-70% during low loaded periods is typical without sacrificing mixing due to the movement of the BioFlex aeration chains. Inspection and service of the BioFusers is done quickly and easily without dewatering the basin, keeping maintenance costs low and eliminating the need for redundant aeration basins. In case of cold climates, the fine bubble diffusion beneath the water surface eliminates icing and minimizes wastewater cooling.

Earthen basins can be used rather than expensive concrete tanks making this extended aeration/activated sludge design the lowest cost alternative available on the market. Integral clarifier(s) are installed using common-wall construction with the extended aeration basin to settle and recycle the stable extended aeration solids.



3. System Components

The Biolac® aeration system consists mainly of suspended aeration chains, fine bubble diffusers, motorized and controlled air valves, clarification equipment, blowers and automatic electrical control system.

3.1. Moving Aeration Chain System

The moving aeration chain suspends fine bubble diffusers near the bottom of the basin. The aeration system is designed so that there are no points of attachment to the bottom of the basin. The aeration system is completely suspended above the basin bottom and is not supported or rested on the bottom. This arrangement allows for ease of access for service and maintenance without dewatering the basin or having a complete aeration system shut down.

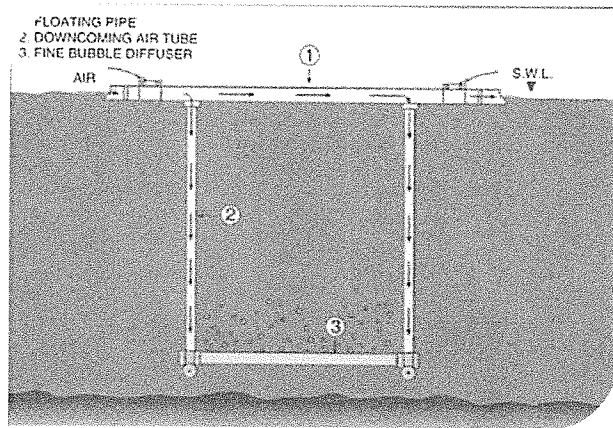

The aeration chain system is designed to be self-propelled and to move back and forth systematically in the wastewater to provide high mixing efficiency of the basin's content. This capability is critical to allow turndown flexibility in the aeration system while maintaining a completely mixed environment.

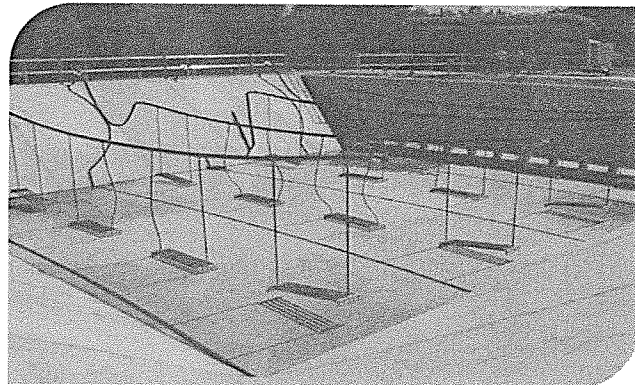



Air is delivered to each aeration chain from one side and connects to the air main through individual branches with butterfly valves. The butterfly valve provides individual control or isolation of the airflow to each chain.

The moving aeration chain is constructed of a single continuous polyethylene header. The moving aeration chain is connected to the Biofuser® by EPDM hose.

3.2. Diffuser Frame

The diffuser frame is formed from an extruded polypropylene compound with sufficient strength to prevent warping or deflection. The end connections of each frame shall be sealed using mechanical welding procedures providing a connection stronger than the unwelded tube.

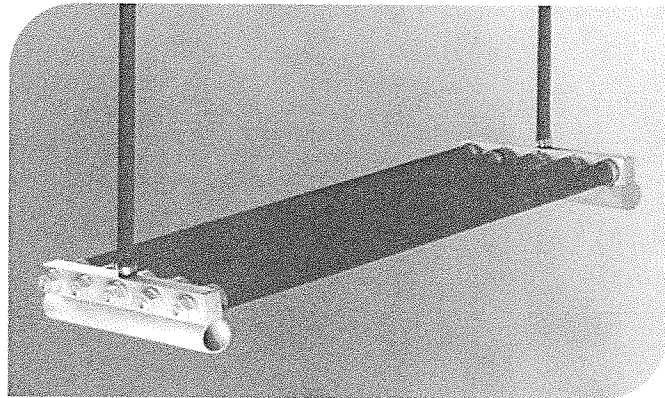

The suspended air diffuser assembly consists of a fully functioning unit capable of housing up to five (5) diffuser tubes total.

3.3. System Integral Clarifier

The existing Biolac® system includes an integral clarifier. The integral clarifier is located downstream of the Biolac® system. The clarifier is typically designed using conventional solids and hydraulic loading rates.

Each clarifier has a flocculating





rake mechanism which consists of a drive assembly and non-drive / pulley assembly.

The sludge removal system includes an airlift pump and a sludge suction pipe and the Return Sludge will flow by gravity upstream of the Biolac® basin. The sludge suction piping for removing the settled solids from the clarifier is located along the length of the clarifier hopper bottom. Holes are placed along the length of the suction pipe for uniform removal of the sludge.

Each integral clarifier includes a fixed overflow weir to control the liquid level in the clarifier and Biolac® basin as well as control the flow to the effluent pipe.

A scum baffle is included in the integral clarifier as well to prevent floating objects from passing over the overflow weir.

3.4. Aeration Design

- a. The aeration requirements for the Biolac® System are summarized in Table 1.
- b. The estimated air and energy requirements and the number of BioFlex© moving aeration headers and Biofuser® units estimated are given in Table 1. A typical BioFlex aeration header and Biofuser® assembly is shown in Drawing SD-38 and SD-37.
- c. The required air for Biolac® basin will be supplied by two (2), 25 Hp (Phase 1) or two (2), 40 Hp (Buildout) positive displacement blowers. One (1) additional blower is provided as an installed spare. Less than one (1) blower is necessary for mixing. Therefore, it is possible to operate one blowers and cut energy usage substantially during periods of low load, such as nighttime operation. The blowers are expected to be located on a concrete pad next to the aeration basins or in a blower building as dictated by local requirements.

3.5. Clarifier Design

The existing integral clarifier will remain as it is except the existing baffle curtain wall will be replaced with concrete baffle wall and existing airlift pump will be replaced with submersible RAS pump. This RAS pump will be connected to the existing sludge suction pipe. The RAS line will be equipped with flowmeter to control RAS flow.



4. Wave-Ox™ Biological Nutrient Removal

Biological Nutrient Removal (BNR) is simplified and affordable with the Biolac® Wave Ox™ process. Simple control of the air flow distribution to the Biolac's moving aeration chains varies the basin dissolved oxygen content by creating a unique moving wave of multiple oxic and anoxic zones. This repeated cycling of environments nitrifies and denitrifies the wastewater without recycle pumping or additional external basins.

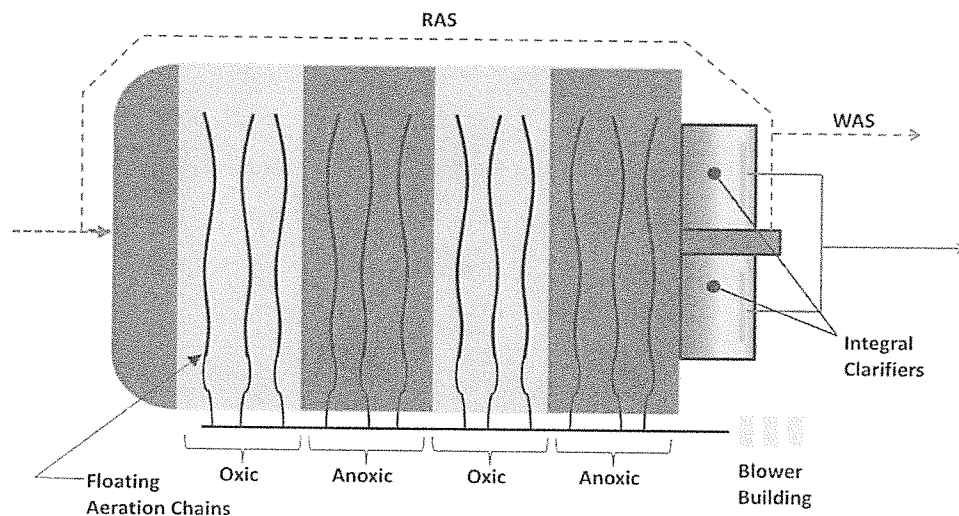

Biological phosphorus removal can also be accomplished by incorporating an upstream anaerobic zone.

The Biolac Wave-Ox™ process not only produces BNR effluent quality with low effluent total nitrogen and total phosphorus, but also includes main features such as

- Single basin BNR process resulting in major construction costs savings by eliminating the need for baffle walls to create independent zones.
- Reduced energy consumption by eliminating the need for internal recycle pumps and mixers for anoxic zones



5. Biolac® Treatment System Preliminary Design Information

Biolac Extended Aeration Basin		
Number of Biolac® Basin(s)	1 (Existing)	2 (Existing+New)
Basin Construction	Earthen	
Approximate Dimensions at Grade (ft) ea	105 x 91	
Approximate Bottom Dimensions (ft) ea	85 x 52	
Basin Free Board (ft)	3	
Side Slope	1.5:1 (Vertical)	
Basin Volume (MG) ea	0.46	
F/M	0.06	0.05
HRT (days)	1.05	1.21
SRT (days)	30-50	50-70
Side Water Depth (ft)	10	
Diffuser Water Depth	9	
Clarifier Size (ft) ea	45 x 23 ea.	
No. of EzClear Clarifier per basin	1 (total 2)	
Clarifier Free Board (ft)	3	
Clarifier Design Hydraulic Loading Rate (gpd/ft ²)	421 (MMF), 1,187 (PHF)	333 (MMF), 964(PHF)
Estimated SOR (lbs/hr) per basin		
Oxidation-only	205	158
Wave Oxidation (including denite credit)	115	90
Estimated SCFM per basin		
Oxidation-only	1,187	910
Wave Oxidation (including denite credit)	666	518
Estimated Brake per basin		
Oxidation-only	43	33
Wave Oxidation (including denite credit)	24	19
# Diffusers per basin	245	196
# Biofuser® Assemblies per basin	49	49
# Biofuser® Model	2205	2204
# BioFlex® Headers per basin	7	7
Blowers	(2 +1) 25 HP	(2 +1) 40 Hp



6. Equipment and Services Supplied

Parkson will supply the following equipment and services for the Biolac® treatment system described above:

Influent Screen

- One (1) AquaGuard® self-cleaning moving media and compactor to replace existing AquaGuard (AG) screen and compactor. Final buildout flows needs downstream liquid level in channel of 1.5’.

OR

- Lowest cost option: One (1) Helisieve® HLS 400 in-channel fine basket screen with integral compaction and dewatering zone. This screen is can be installed in the both the existing channel and by pass channel.

Existing Clarifier Internals (Basin 1)

- One (1) new design rake assembly with single side skimming feature, for existing integral clarifier equipment including flocculating mechanism for single side skimming, rake drive with cable and limit switches.
- One (1) 4” actuated WAS valve to replace WAS gate. This will require to modify existing WAS line by stepping down to 4” before and step up from 4” after WAS valve.
- Final installation inspection, start-up supervision and operator training.
- Existing biosolids removal piping, sludge suction pipe, effluent overflow weir, scum pumps, scum weir and clarifier controls (in existing Biolac panel) are EXCLUDED and will be reused.

RAS Flow automation (existing Basin 1)

- One (1) influent flowmeter for 12” influent pipe.
- One (1) submersible RAS pump and one (1) RAS flowmeter for existing integral clarifier.
- PLC based remote-mounted control system with HMI for RAS flow automation including control enclosure, relays and control switches for all



motors, and components in the system. This PLC based control panel will be designed for future upgrades for operation of the Biolac® Wave-Ox™ System for Basin 1, controls for basin 2 (final buildout), addition of influent screen controls. This future upgrade will require to add hardware and change PLC programming. The upgrade costs is not included in pricing.

- Blower VFDs, DO probe/analyzer, WOx valves and control are excluded. This will be added during upgrade phase.
- Final installation inspection, start-up supervision and operator training.

Phase 1 (Basin 1-except clarifier internals)

- Complete BioFlex® moving chains for one (1) basin, with BioFuser® aeration units including, reinforced hi-temperature connecting hose, HDPE piping, restraining cable system and required hardware.
- Electric motor actuated butterfly valves for individual control of each BioFlex aeration chain. valves for individual control of each BioFlex aeration chain.
- Qty three (3) complete, 25 Hp, blower assemblies (PD blowers) including motor and required backflow prevention valves, pressure gauges and accessories (includes one installed spare blower for redundancy).
- One (1) influent flowmeter for 12" influent pipe.
- One (1) submersible RAS pump and one (1) RAS flowmeter for existing integral clarifier. Internal components for existing clarifier are EXCLUDED and will be reused.
- One (1) dissolved oxygen probe and analyzer per basin.
- Remote-mounted control system for operation of the Biolac® Wave-Ox™ System including control enclosure, VFDs, relays and control switches for all motors, and components in the system.
- Final installation inspection, start-up supervision and operator training.



Buildout (Both Basins)

- Complete BioFlex® moving chains for two (2) basins, with BioFuser® aeration units including, reinforced hi-temperature connecting hose, HDPE piping, restraining cable system and required hardware.
- Electric motor actuated butterfly valves for individual control of each BioFlex aeration chain.
- Qty three (3) complete, 40 Hp, blower assemblies (PD blowers) including motor and required backflow prevention valves, pressure gauges and accessories (includes one installed spare blower for redundancy).
- One (1) integral clarifier equipment for second basin, including biosolids removal piping, sludge suction pipe, flocculating mechanism with single side skimming features, scum removal pipe and overflow weir. Internal components for existing clarifier for basin #1 are EXCLUDED and will be reused.
- Two (2) influent flowmeters for 12" influent pipe.
- Two (2) submersible RAS pumps (one per basin), for integral clarifiers.
- Two (2) RAS flowmeters (one per basin).
- Two (2) dissolved oxygen probes and analyzers (one per basin).
- Two (2) Air flowmeters (one per basin), to be installed on air main header.
- Two (2) Air control valves (one per basin), to be installed on air main header.
- PLC based remote-mounted control system with HMI for operation of the Biolac® Wave-Ox™ System and clarifiers for both basins, including control enclosure, VFDs, relays and control switches for all motors, and components in the system.
- Final installation inspection, start-up supervision and operator training.



7. Cost Estimate and Term

- a. The budget price for the equipment and services supplied is
 - for One (1) AquaGuard® and compactor \$ 120,000
 - for One (1) washer compactor for AquaGuard® \$ 40,000
 - for One (1) Helisieve® HLS 400 \$ 65,000
 - Existing Clarifier Rake Assembly – new design (Basin 1 only)..... \$ 51,000
 - for RAS Flow automation (existing Basin 1 only) \$ 220,000
 - for Phase 1 (Full Scope – Basin 1) \$ 458,000
 - for Buildout (Both Basins) \$ 715,000

FOB Factory, Freight Allowed.
- b. Terms are 90% net 30, 10% upon startup.
- c. Approval drawings-typically 8-12 weeks after receipt of written order.
- d. Equipment Shipment - typically 16-20 weeks after complete release for manufacture.

8. Supplemental Information and References

- a. Biolac® System Oxygen Requirements
- b. Typical Drawings
 - SD-38 "BioFlex Moving Aeration Chain with Biofuser® Series 2205"
 - SD-37 "BioFlex Moving Aeration Chain with Biofuser® Series 2204"
 - SD-12 "Wave-Ox Valves"
 - SD-7 "Anchor Post with Hook Detail"
 - SD-8 "Positive Displacement Aeration Blower Assembly"



BIOLAC[®] SYSTEM OXYGEN REQUIREMENTS

Project: La Contenta, CA (Phase 1)

Date: May 5, 2017

Data

Basins		1	
		Phase 1	
Influent Flow	Per Basin Q	0.44 MGD	1.67 MLD
Basin Volume	Per Basin V	62028 ft ³	

Influent		Effluent		% Removal
BOD _{in}	187	BOD _{out}	0 mg/l	100.00%
TKN _{in}	79	NO ₃ _{out}	0 mg/l	100.00%
NH ₃ _{in}	60	NH ₃ _{out}	0 mg/l	

BOD	1.5	Lbs of O ₂ /Lb BOD
TKN-N	4.6	Lbs of O ₂ /Lb NH ₃ -N
NO ₃	2.9	Lbs of O ₂ /Lb NO ₃ -N
% denitrification		89%

Loading Rates

Hydraulic Residence Time, HRT

$$HRT = \frac{V \text{ (ft}^3\text{)}}{Q \text{ (ft}^3\text{/day)}}$$

1.05 days

BOD Loading Rate (per Basin), BOD_{Load}

$$BOD_{Load} = BOD_{in} \text{ (mg/L)} * \% \text{ Removal} * Q \text{ (MGD)} * 8.34 \text{ (lbs/gal)}$$

686.00 lb/d

BOD Volumetric Loading Rate (per Basin), BOD_{VolLoad}

$$BOD_{VolLoad} = \frac{BOD_{Load}}{V}$$

11.06 Lb/1000 ft³

TKN Loading Rate (per Basin), TKN_{Load}

$$TKN_{Load} = TKN_{in} \text{ (mg/L)} * \% \text{ Removal} * Q \text{ (MGD)} * 8.34 \text{ (lbs/gal)}$$

290.00 lb/d

AOR

Actual Oxygen Requirement, AOR

AOR _{BOD}	1.5 Lbs of O ₂ /Lb BOD	*	686.0 lb/d	=	1029.0 lb/d
AOR _{TKN}	4.6 Lbs of O ₂ /Lb NH ₃ -N	*	290.0 lb/d	=	1334.0 lb/d
Denite Credit	2.9 Lbs of O ₂ /Lb NO ₃ -N	*	256.7 lb/d	=	744.4 lb/d
Total AOR					2363.00 lb/d Non-WaveOx
					1618.62 lb/d w/ Denite Credit

SOR

Standard Oxygen Demand, SOR

$$SOR = \frac{C_{S,20}}{\alpha * (\beta * C_{S,T,H} - C_L) * (\theta^{T_u - 20}) * F}$$

Where

C _{S,20}	DO Saturation Concentration in Clean Water @ 20C & 1 atm	9.092426 mg/L
C _{S,T,H}	Avg DO Sat. Conc.in Clean Water in Aeration Tank @ T °C & altitude H	9.4177 mg/L
C _L	Operating Oxygen Concentration (Non-WaveOx)	2 mg/L
	Operating Oxygen Concentration (WaveOx)	0.5 mg/L
α	Oxygen Transfer Correction Factor for Waste	0.7
β	Salinity-surface tension correction factor	0.95
θ		1.024
T	Operating Temperature	20 °C
F	Fouling Factor	0.9
SOR	Standard Oxygen Req. in tap water @ 20C & 0 lb O ₂ /day	

SOR/AOR	2.08	Non-WaveOx
	1.71	WaveOx

$$SOR = AOR * \left(\frac{SOR}{AOR} \right) \text{ Ratio}$$

	Non-WaveOx	w/denit Credit	
SOR	4909.3	2765.6	lb O ₂ /day
	204.6	115.2	lb O ₂ /hr



BIOLAC[®] SYSTEM OXYGEN REQUIREMENTS

Project: La Contenta, CA (Buildout)

Date: May 5, 2017

Data

Basins 2		Buildout							
Influent Flow	Per Basin	Q	0.39	MGD	1.46	MLD			
	Total	Q _{Total}	0.77	MGD	2.91	MLD			
Basin Volume	Per Basin	V	62028	ft ³					
	Total	V _{Total}	124056	ft ³					

Influent	Effluent	% Removal	
BOD _{in} 166	BOD _{out} 0 mg/l	100.00%	BOD 1.5 Lbs of O2/Lb BOD
TKN _{in} 69	NO ₃ _{out} 0 mg/l	100.00%	TKN-N 4.6 Lbs of O2/Lb NH3-N
NH ₃ _{in} 60	NH ₃ _{out} 0 mg/l		NO ₃ 2.9 Lbs of O2/Lb NO ₃ -N

% denitrification **87%**

Loading Rates

Hydraulic Residence Time, HRT

$$HRT = \frac{V \text{ (ft}^3\text{)}}{Q \text{ (ft}^3\text{/day)}}$$

1.21 days

BOD Loading Rate (per Basin), BOD_{Load}

$$BOD_{Load} = BOD_{in} \text{ (mg/L)} * \% \text{ Removal} * Q \text{ (MGD)} * 8.34 \text{ (lbs/gal)}$$

534.00 lb/d

BOD Volumetric Loading Rate (per Basin), BOD_{Vol Load}

$$BOD_{Vol Load} = \frac{BOD_{Load}}{V}$$

8.61 Lb/1000 ft³

TKN Loading Rate (per Basin), TKN_{Load}

$$TKN_{Load} = TKN_{in} \text{ (mg/L)} * \% \text{ Removal} * Q \text{ (MGD)} * 8.34 \text{ (lbs/gal)}$$

223.00 lb/d

AOR

Actual Oxygen Requirement, AOR

AOR _{BOD}	1.5 Lbs of O2/Lb BOD	*	534.0 lb/d	=	801.0 lb/d
AOR _{TKN}	4.6 Lbs of O2/Lb NH3-N	*	223.0 lb/d	=	1025.8 lb/d
Denite Credit	2.9 Lbs of O2/Lb NO3-N	*	193.8 lb/d	=	562.0 lb/d
Total AOR					1826.80 lb/d Non-WaveOx
					1264.78 lb/d w/ Denite Credit

SOR

Standard Oxygen Demand, SOR

$$\frac{SOR}{AOR} = \frac{C_{S,20}}{\alpha * (\beta * C_{S,T,H} - C_L) * (\theta^{T_d-20}) * F}$$

Where

C _{S,20}	DO Saturation Concentration in Clean Water @ 20C & 1 atm	9.092426 mg/L
C _{S,T,H}	Avg DO Sat. Conc.in Clean Water in Aeration Tank @ T °C & altitude H	9.4177 mg/L
C _L	Operating Oxygen Concentration (Non-WaveOx)	2 mg/L
	Operating Oxygen Concentration (WaveOx)	0.5 mg/L
α	Oxygen Transfer Correction Factor for Waste	0.7
β	Salinity-surface tention correction factor	0.95
θ		1.024
T	Operating Temperature	20 °C
F	Fouling Factor	0.9
SOR	Standard Oxygen Req. in tap water @ 20C & 0 l lb O2/day	

SOR/AOR		2.08	Non-WaveOx
		1.71	WaveOx

$$SOR = AOR * \left(\frac{SOR}{AOR} \right) \text{ Ratio}$$

SOR	Per Basin		lb O2/day	Total (All Basins)		lb O2/day
	Non-WaveOx	w/denit Credit		Non-WaveOx	w/denit Credit	
	3795.3	2161.0		7590.6	4322.1	
	158.1	90.0	lb O2/hr	316.3	180.1	lb O2/hr

This drawing and all appurtenant matter contains information proprietary to PARKSON CORPORATION and is loaned subject to return upon demand and must not be reproduced, copied, loaned, reloaned nor used for any purpose other than that for which it is specifically furnished without expressed written consent of PARKSON CORPORATION.

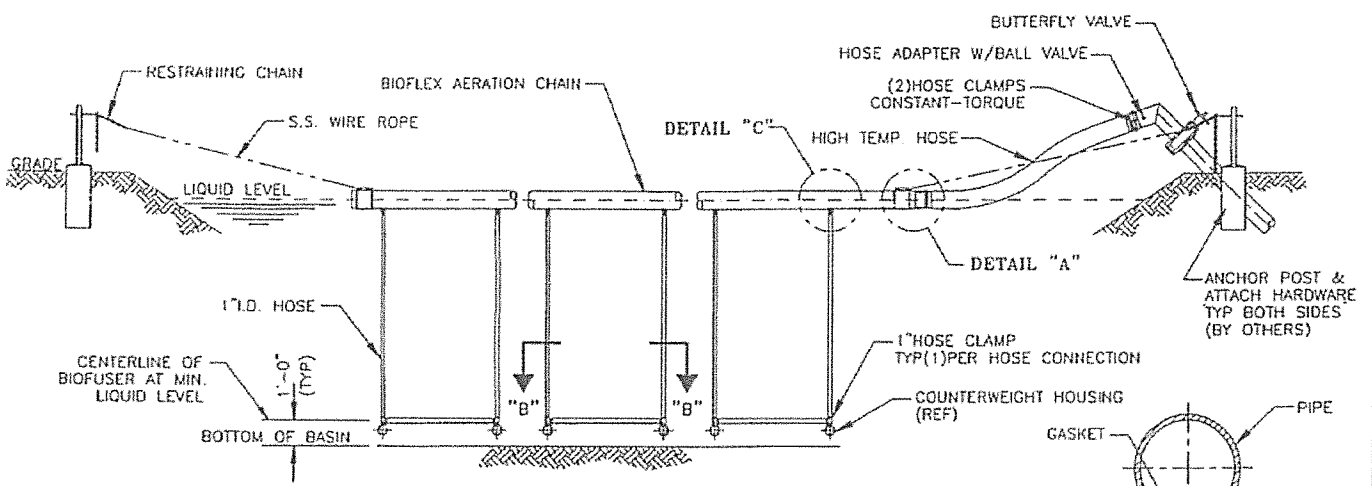

ELEVATION (BIOFLEX/BIOFUSER ASS'Y)

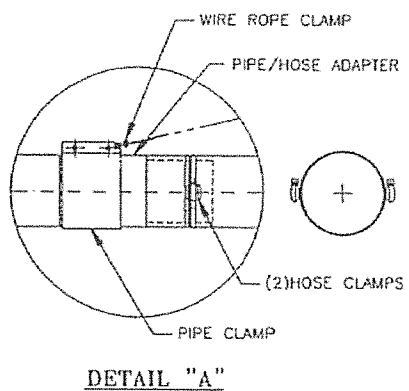

DETAIL "A"

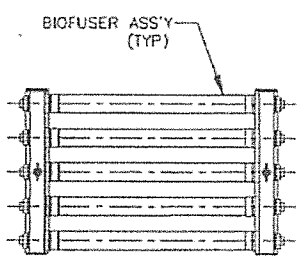

VIEW "B-B"

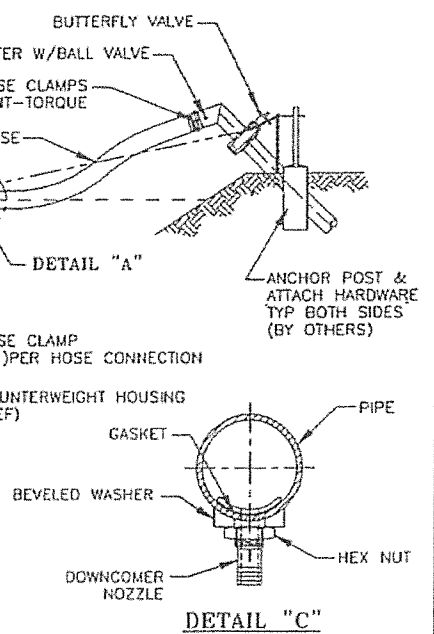

DETAIL "C"

NOTES:

1. CIVIL & CONCRETE DESIGN NOT BY PARKSON CORP
2. TWO(2)HOSE CLAMPS TO BE INSTALLED AT EACH HOSE CONNECTION. WHEN TIGHTENED, WORM GEARS SHOULD BE 180° FROM EACH OTHER.
3. BIOFLEX WILL BE PROVIDED IN STANDARD LENGTHS. FUSION WELDING & DRILLING DOWNCOMER HOLE IN FIELD WILL BE REQUIRED BY CONTRACTOR.

PARKSON CORPORATION					
BIOLAC LONG SLUDGE AGE SYSTEM BIOFLEX MOVING AERATION CHAIN WITH BIOFUSER SERIES 2005					
Drawn By G.E.	Checked By	Approved By	Micro Rev.	CAD No. 20-33	Loc. sheet 15
Date 2/1/96	Date	Date	Date	ENG. Scale NONE	CAD in scale 2:1
Location			Proj. No.	Rev.	
				SD-38	A

This drawing and all subsequent matter contains information proprietary to PARKSON CORPORATION and is loaned subject to return upon demand and must not be reproduced, copied, loaned, revised nor used for any purpose other than that for which it is specifically furnished without expressed written consent of PARKSON CORPORATION.

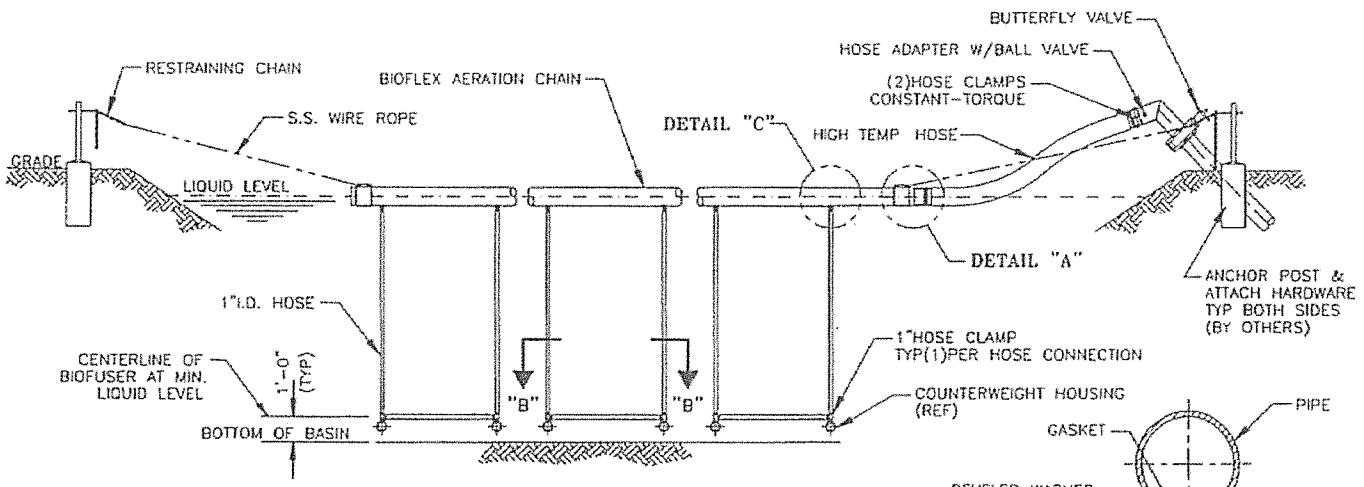

ELEVATION (BIOFLEX/BIOFUSER ASS'Y)

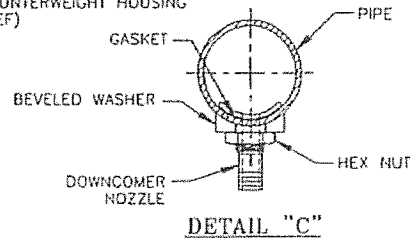

DETAIL "C"

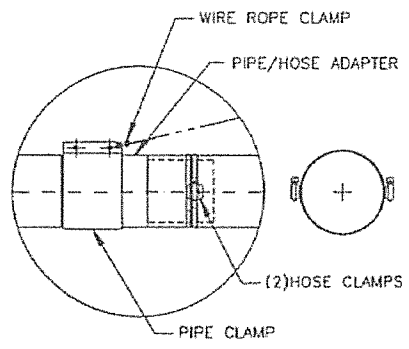

DETAIL "A"

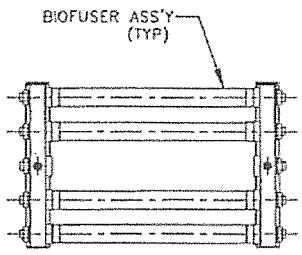

VIEW "B-B"

NOTES:

1. CIVIL & CONCRETE DESIGN NOT BY PARKSON CORP
2. TWO(2) HOSE CLAMPS TO BE INSTALLED AT EACH HOSE CONNECTION. WHEN TIGHTENED, WORM GEARS SHOULD BE 180° FROM EACH OTHER.
3. BIOFLEX WILL BE PROVIDED IN STANDARD LENGTHS FUSION WELDING & DRILLING DOWNCOMER HOLE IN FIELD WILL BE REQUIRED BY CONTRACTOR.

PARKSON CORPORATION					
BIOLOC LONG SLUDGE AGE SYSTEM BIOFLEX MOVING AERATION CHAIN WITH BIOFUSER SERIES 2004					
Drawn By G.C.	Checked By	Approved By	Micro Rev.	CAD No. SD-33	Loc. Status 15
Date 2/1/95	Date	Date	Date	DWG. Scale NONE	CAD TAG R4
Location			Dwg. No.	Rev.	
			SD-37	A	

This drawing and all information matter contained herein are the property of PARKSON CORPORATION and is loaned subject to return. No part of this drawing or information shall be reproduced or transmitted in any form or by any means, electronic, mechanical, photocopying, recording, or by any information storage and retrieval system, without the prior written permission of PARKSON CORPORATION.

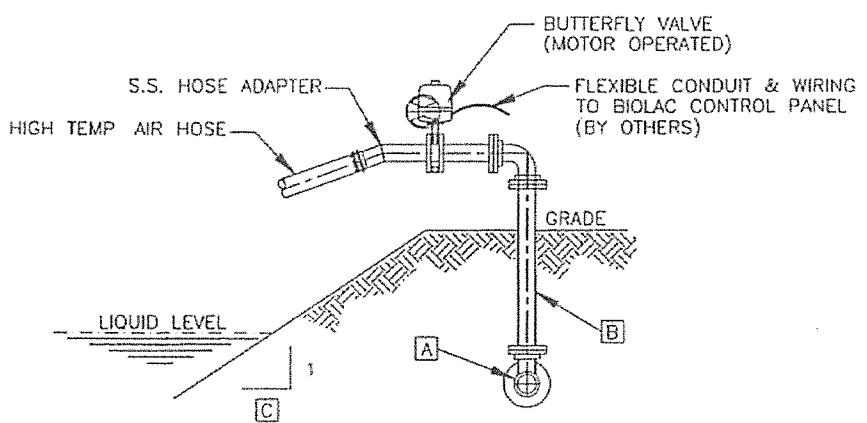

OPTION #1

ITEM	DESCRIPTION	DIM
A	AIR HEADER DIAMETER	
B	AIR FEED PIPE DIAMETER	
C	WALL SLOPE	

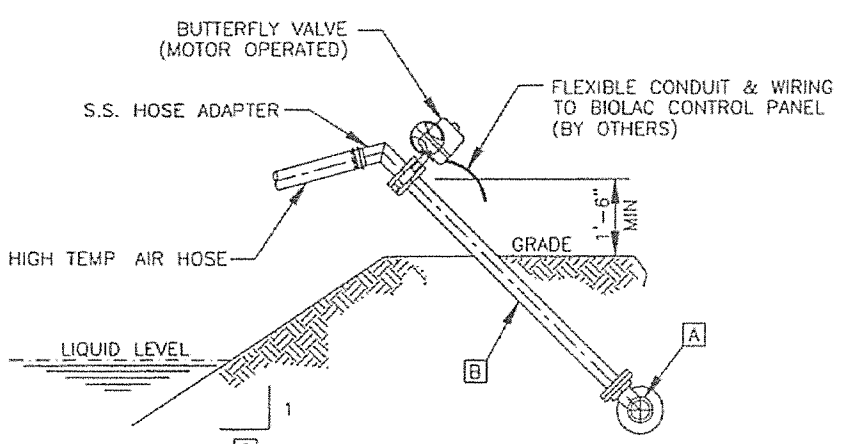

OPTION #2

PARKSON CORPORATION						
BIOLAC LONG SLUDGE AGE SYSTEM WAVE-OX VALVES						
Drawn By G.C.	Checked By	Approved By	Micro Rev.	CAJ No SD-12	Loc 15	Status
Date 2/1/75	Date	Date	Date	DWG SCALE NONE	CAJ NO 12	REVISE
Location				Dwg No SD-12	Rev. A	

This drawing and all apparatus matter contains information proprietary to PARKSON CORPORATION and is loaned subject to return
 conditions and must not be reproduced, copied, issued, revealed nor used for any purpose other than that for which it is specifically
 intended without approval written consent of PARKSON CORPORATION.

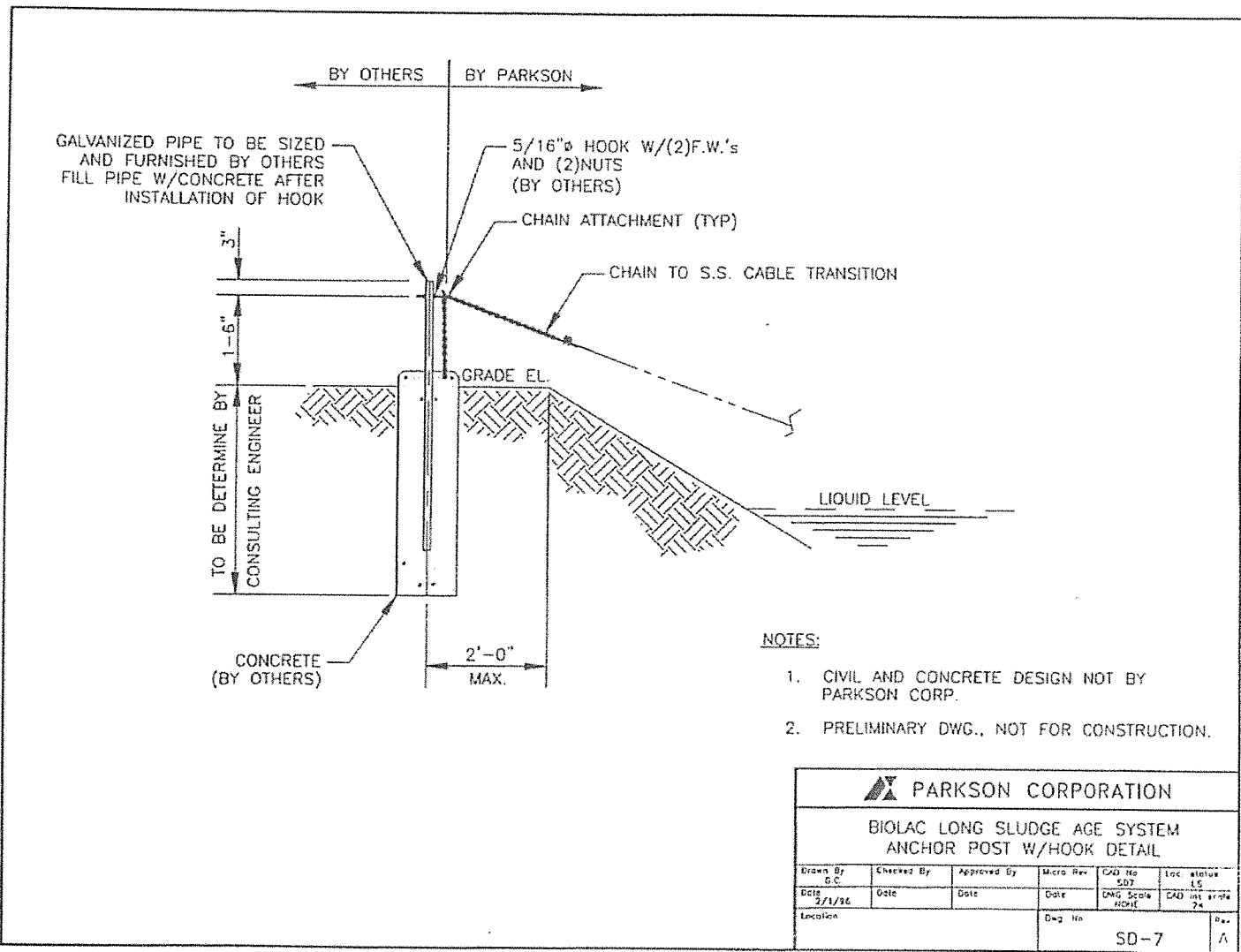

NOTES:

1. CIVIL AND CONCRETE DESIGN NOT BY PARKSON CORP.
2. PRELIMINARY DWG., NOT FOR CONSTRUCTION.

PARKSON CORPORATION					
BIOLAC LONG SLUDGE AGE SYSTEM ANCHOR POST W/HOOK DETAIL					
Drawn By D.C.	Checked By	Approved By	Micro Rev.	CAD No SD7	Loc status 15
Date 3/1/86	Date	Date	Date	DWG Scale ASHT	CAD Unit 24
Location			Dwg No	SD-7	Rev. A

This drawing and all operational matter herein is the property of PARKSON CORPORATION and is loaned subject to return to PARKSON CORPORATION. It is not to be used for any purpose other than that for which it is specifically furnished without expressed written consent of PARKSON CORPORATION.

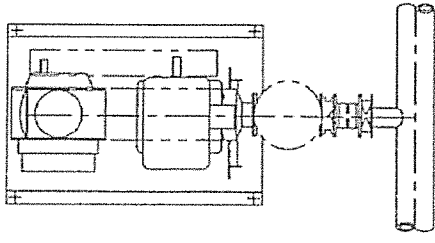

PLAN

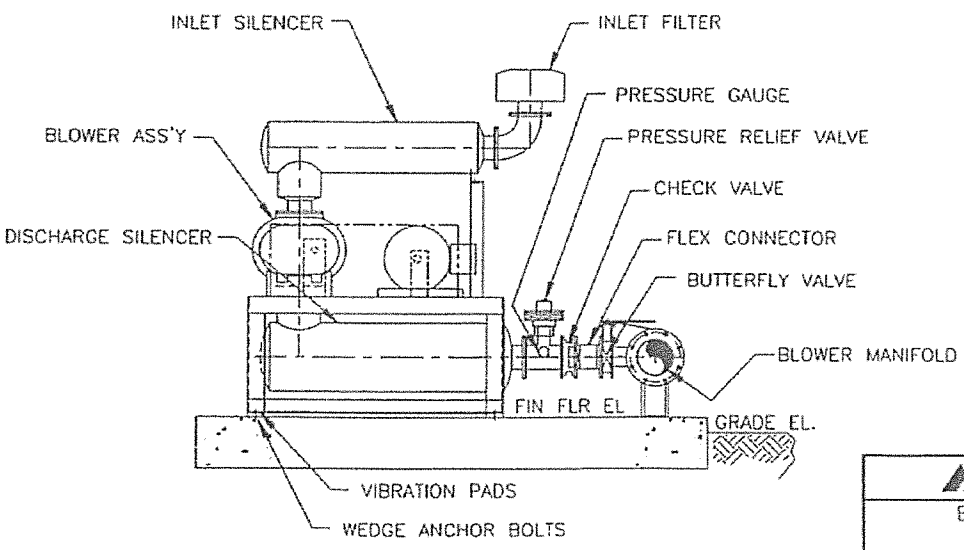

ELEVATION

PARKSON CORPORATION					
BIOLAC LONG SLUDGE AGE SYSTEM POSITIVE DISPLACEMENT AERATION BLOWER ASS'Y					
Drawn By G.C.	Checked By	Approved By	Micro Rev.	CAD No. 508	Loc status
Date 2/1/95	Date	Date	Date	ENG STORE NORME	CAD int name 37
Location			Proj. No.	SD-8	Rev. A

Agenda Item

DATE: December 13, 2017

TO: CCWD Board of Directors

FROM: Dave Eggerton, General Manager 

RE: Consideration of Purchase of Real Property (APN's 046-019-051, 073-042-127, and 073-042-129) for Expansion of La Contenta Wastewater Facilities

RECOMMENDED ACTION

Motion: _____ / _____ approving Resolution No. 2017- _____ Authorizing the General Manager to Complete a Purchase Agreement and Accept the Grant Deed for Real Property Commonly Identified as APN'S 046-019-051, 073-042-127, and 073-042-129.

SUMMARY

On December 13, 2017, the Board of Directors of the Calaveras County Water District (CCWD) adopted the updated La Contenta Wastewater Master Plan (Master Plan) prepared by the professional water and wastewater resource engineering firm of Kennedy/Jenks Consultants. As it states, the Master Plan provides a series of cost-effective, phased improvements to meet planned growth, comply with current and future state and federal regulations and improve overall operation of the system. To this end, the Master Plan expressly recognizes the critical need for additional capacity for both the storage and disposal of treated effluent. Thus it recommends the incorporation of additional land into the system for spray area and the expansion of existing effluent storage such as the Lower Effluent Storage (LES) reservoir. With this agenda item the Board is asked to consider the purchase of real property immediately adjacent to the La Contenta Wastewater Plant and the LES to meet these vitally important needs of the District and its current and future customers.

The real property presented for purchase includes 52.81 acres (APN'S 046-019-051, 073-042-127, and 073-042-129) located in the vicinity of Old Hogan Dam Road and Harper Street in Valley Springs. As depicted in the attached map, the property is located directly between the District's La Contenta Wastewater Plant and the LES. A pipeline that conveys treated effluent from the plant to the LES already traverses the property. This uniquely situated property would allow the District to immediately expand its spray area by connecting irrigation equipment to the existing pipeline at a relatively nominal additional cost. It would also afford the opportunity to expand the existing LES

to provide necessary additional storage for treated effluent without having to experience the extraordinarily high cost and complexity of permitting and constructing an entirely new reservoir under state and federal regulatory jurisdiction. Preliminary review by professional consultants of the District show no environmental or archaeological issues that would preclude use of the property for either purpose. Contrastingly, no other potential option for acquiring new property or utilizing existing property of the District provides either the benefits or cost-effectiveness to meet the current and future needs of the District as identified in the Master Plan.

Unlike the property under consideration today, the functionality of other land owned by the District in the general vicinity is severely constrained by environmental and watercourse limitations imposed under state and federal law and would require the construction of long stretches of new pipeline (over 1 mile) across the land of others that the District does not have the existing rights to cross. These additional costs are estimated to be in the range of \$1.5 million.

District staff have negotiated in good faith for an extended period of time with the owner of the property to reach the most beneficial purchase price for the District and its ratepayers. Originally listed for sale at \$880,000, the purchase price has been negotiated to a final amount \$635,000. This represents fair market value for a uniquely situated property and is within a reasonable range of an appraised estimate of its value obtained by the District in 2016.

FINANCIAL CONSIDERATIONS:

Financial considerations are discussed in more detail in the accompanying memo from Jeffrey Meyer, Director of Administrative Services. Total costs, including purchase price and closing costs, is \$640,000. The two funding sources for the property purchase are the La Contenta Sewer Expansion Fund (Fund 564), \$200,000, and a \$440,000 loan by the Interest Reserve Fund (Fund 108) to the La Contenta Wastewater Expansion Fund (Fund 564). The adopted FY 2017-18 CIP Budget of \$10,767,000 would be increased by \$640,000.

Attachments:

- 1. Map of Real Property under Consideration*
- 2. CCWD Resolution No. 2017-__ Authorizing the General Manager to Complete a Purchase Agreement and Accept the Grant Deed for Real Property Commonly Identified as APN'S 046-019-051, 073-042-127, and 073-042-129.*

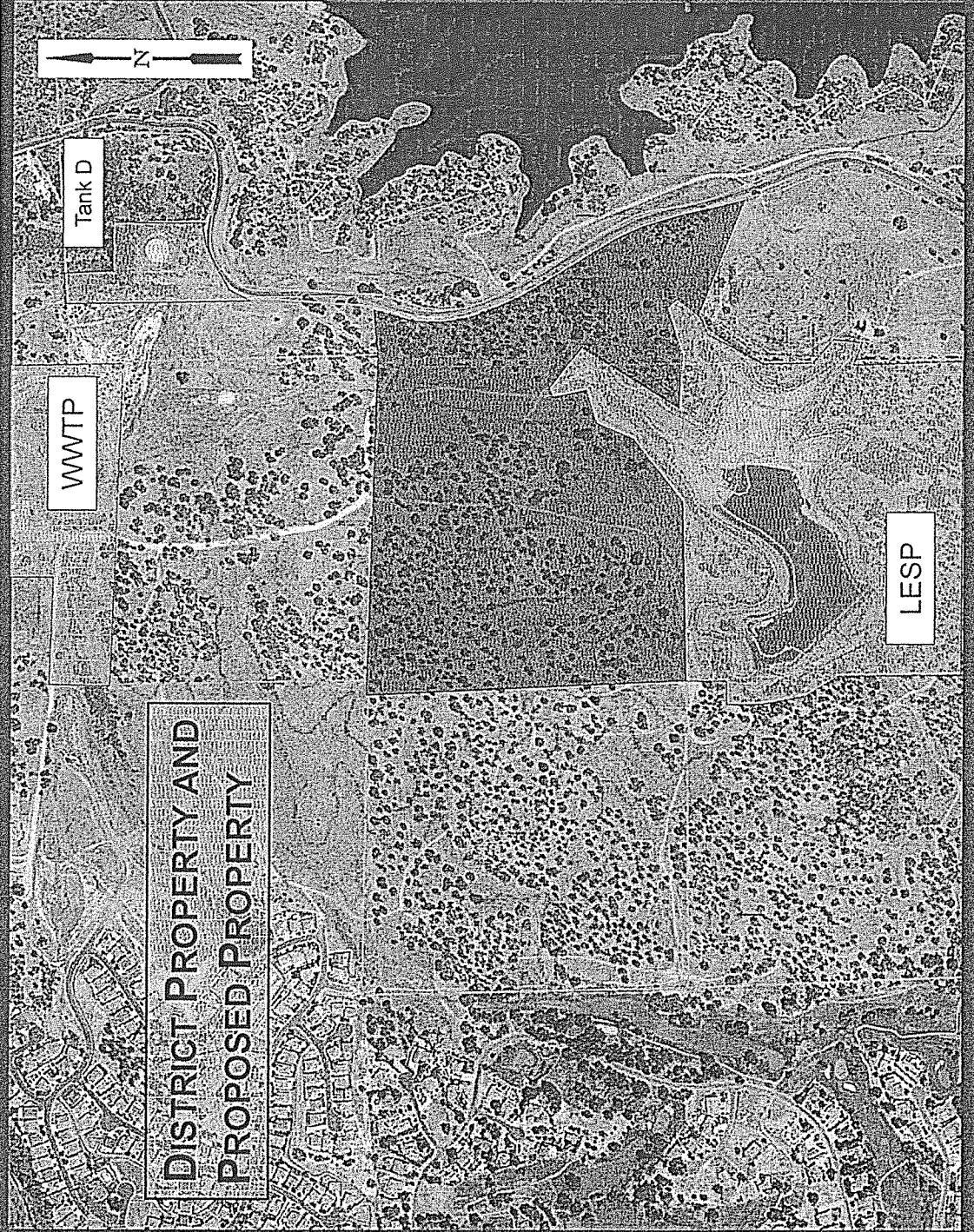

Tank D

WWTP

LESP

DISTRICT PROPERTY AND
PROPOSED PROPERTY

RESOLUTION NUMBER 2017 –

**A RESOLUTION OF THE BOARD OF DIRECTORS
OF THE CALAVERAS COUNTY WATER DISTRICT**

**AUTHORIZING THE GENERAL MANAGER TO COMPLETE A PURCHASE
AGREEMENT AND ACCEPT THE GRANT DEED FOR
REAL PROPERTY COMMONLY IDENTIFIED AS
APN'S 046-019-051, 073-042-127, AND 073-042-129**

WHEREAS, on December 13, 2017, the Board of Directors of the Calaveras County Water District (CCWD) adopted the updated La Contenta Wastewater Master Plan (Master Plan); and

WHEREAS, the Master Plan identifies a high priority need for CCWD to expand existing wastewater effluent storage and develop additional wastewater effluent disposal capacity; and

WHEREAS, acquiring the real property identified as APN 046-019-051, APN 073-042-127, and APN 073-042-129, immediately adjacent to the La Contenta wastewater plant and effluent storage reservoir, provides the most cost-effective and beneficial means for the District to achieve necessary additional effluent storage and disposal capacity to improve wastewater service reliability and allow for necessary future expansion of services in the La Contenta service area in accordance with the findings and recommendations of the Master Plan; and

WHEREAS, along with this finding of necessity for purchase of this property, the Board expressly finds that this property is uniquely suited to meet the needs of the District and its customers given its close proximity to existing District facilities and its other advantages over other limited options in the area that are far less desirable and/or unable to meet the needs of the District due to land use, environmental, economic, and other factors; and

WHEREAS, the Board further finds, after initial review by professional consultants retained by the District that no cultural or environmental issues have been identified that would prohibit use of this property for its intended purposes; and

WHEREAS, the purchase price is the result of extensive, good faith negotiations between the property owner and District that represents fair market value, serves the best interests of the public trust, and avoids the substantial costs and other undesired impacts of having to initiate legal proceedings in eminent domain to acquire the property.

NOW, THEREFORE, BE IT RESOLVED by the Board of Directors of the Calaveras County Water District, that the General Manager is authorized to purchase the real property identified as APN 046-019-051, APN 073-042-127, and APN 073-042-129 for the amount of \$635,000 plus appropriate transaction costs.

BE IT FURTHER RESOLVED

upon completion of transaction, the General Manager is authorized to accept the Grant Deed for the real property identified as APN 046-019-051, APN 073-042-127, and APN 073-042-129.

BE IT FURTHER RESOLVED that the Grant Deed and this Resolution shall be recorded upon execution of the appropriate parties.

PASSED AND ADOPTED this 13th day of December, 2017 by the following vote:

AYES:

NOES:

ABSENT:

ABSTAIN:

CALAVERAS COUNTY WATER DISTRICT

President
Board of Directors

ATTEST:

Mona Walker, Clerk to the Board

Agenda Item

DATE: December 13, 2017

TO: Dave Eggerton, General Manager 

FROM: Jeffrey Meyer , Director of Administrative Services

RE: Discussion / Action Regarding Amending the FY 2017-18 CIP Budget for the Purchase of APN's 046-019-051, 073-042-127, and 073-042-129 for the La Contenta Wastewater Facilities

RECOMMENDED ACTION:

Motion: _____ / _____ approving Resolution No. 2017- _____ Amending the FY 2017-18 CIP Budget for the Purchase of APN's 046-019-051, 073-042-127, and 073-042-129 for the La Contenta Wastewater Facilities.

SUMMARY:

The District has determined that the purchase of APN's 046-019-051, 073-042-127, and 073-042-129 (Valley Springs) adjacent to the La Contenta wastewater plant and effluent storage reservoir for the La Contenta Wastewater facilities provides the most cost-effective and beneficial means of improving wastewater service reliability and allowing for necessary expansion of services in the La Contenta service area in accordance with the findings and recommendations of the La Contenta Wastewater Master Plan update adopted by the Board on December 13, 2017. As such, the purchase needs to be added to the FY 2017-18 Capital Improvement Program (CIP). The cost of the properties, including closing costs, is estimated to be \$640,000. The purchase will be funded by a \$200,000 contribution from the La Contenta Sewer Expansion Fund (Fund 564), and a \$440,000 loan by the Interest Reserve Fund (Fund 108) to the La Contenta Sewer Expansion Fund.

As per the "CCWD Internal Loan Agreement" used to finance the Operations Headquarters Building, approved by Resolution 2012-03 on January 11, 2012 (attached), the La Contenta Sewer Expansion Fund (Fund 564) loaned the Building Fund \$500,000 to help fund the construction of the Operations Headquarters Building. Loan payments for the first six years have been "interest only." Starting in FY 2018-19, and continuing for five years through FY 2022-23, the loan payments to the La Contenta Sewer Expansion Fund will include a principal amount of \$100,000. The proceeds from the "CCWD Internal Loan Agreement" repayment plan will be used by the La Contenta Sewer Expansion Fund to fund the loan payments to the Interest Reserve Fund.

The proposed "La Contenta Sewer Expansion Fund Loan Agreement" (attached) will include a repayment schedule of a term of not to exceed five (5) years at an interest rate of the greater of 2.5 percent (2.5%) or the weighted average of the District's current rate of return on investments. The applicable interest rate payable will be evaluated annually at the date of the annual loan payment.

FINANCIAL CONSIDERATIONS:

The total cost of the properties, including closing costs, is estimated to \$640,000. The two funding sources for the property purchase are the La Contenta Sewer Expansion Fund (Fund 564), \$200,000, and a \$440,000 loan by the Interest Reserve Fund (Fund 108) to the La Contenta Wastewater Expansion Fund (Fund 564). The adopted FY 2017-18 CIP Budget of \$10,767,000 will be increased by \$640,000.

- Attachments:*
- 1. Resolution 2017 - ___ Amending the FY 2017-18 CIP Budget for the Purchase of APN's 046-019-051, 073-042-127, and 073-042-129 for the La Contenta Wastewater Facilities and Budget Adjustment 18-02*
 - 2. CCWD La Contenta Sewer Expansion Fund Loan Agreement*
 - 3. Resolution 2012-03 Approving Internal Loan Agreement to Finance the CCWD Operations Headquarters Building*

RESOLUTION NO. 2017-

**A RESOLUTION OF THE BOARD OF DIRECTORS OF THE
CALAVERAS COUNTY WATER DISTRICT**

**AMENDING THE FY 2017-18 CIP BUDGET PURCHASE OF
APN'S 046-019-051, 073-042-127, AND 073-042-129
FOR THE LA CONTENTA WASTEWATER FACILITIES**

WHEREAS, the Board of Directors of the CALAVERAS COUNTY WATER DISTRICT adopted Resolution 2017-29 on June 28, 2017 approving the Fiscal Year 2017-18 Capital Improvement Program Budget (CIP) in the amount of \$10,767,000; and

WHEREAS, the District has determined that the purchase of APN's 046-019-051, 073-042-127, and 073-042-129 (Valley Springs) adjacent to the La Contenta wastewater plant and effluent storage reservoir for the La Contenta Wastewater facilities provides the most cost-effective and beneficial means of improving wastewater service reliability and allowing for necessary expansion of services in the La Contenta service area in accordance with the findings and recommendations of the La Contenta Wastewater Master Plan update adopted by the Board on December 13, 2017. As such, the purchase needs to be added to the FY 2017-18 Capital Improvement Program (CIP); and

WHEREAS, the purchase of APN's 046-019-051, 073-042-127, and 073-042-129, including closing costs, is estimated at \$640,000; and

WHEREAS, funding for the purchase of the properties will come from the La Contenta Wastewater Expansion Fund (Fund 564), \$200,000, and from a loan by the Interest Reserve Fund (Fund 108) to the La Contenta Wastewater Expansion Fund (Fund 564) in the amount of \$440,000; and

WHEREAS, the Board of Directors of the CALAVERAS COUNTY WATER DISTRICT does hereby find that it is in the best interest of the Calaveras County Water District to amend the adopted FY 2017-18 CIP Budget accordingly.

NOW, THEREFORE, BE IT RESOLVED the Board of Directors of the CALAVERAS COUNTY WATER DISTRICT adopts an amendment to the Fiscal Year 2017-18 Capital Improvement Program (CIP) Budget as set forth in Budget Adjustment 18-02, attached hereto and made a part hereof, and authorizes the Director of Administrative Services to record the appropriate accounting entries.

BE IT FURTHER RESOLVED the Board of Directors of the CALAVERAS COUNTY WATER DISTRICT approves the La Contenta Wastewater Expansion Fund Loan Agreement in an amount not to exceed \$440,000, attached hereto and made a part hereof, and authorizes the General Manager to execute said Agreement.

PASSED AND ADOPTED this 13th day of December, 2017 by the following vote:

AYES:
NOES:
ABSTAIN:
ABSENT:

CALAVERAS COUNTY WATER DISTRICT

President
Board of Directors

ATTEST:

Mona Walker, Clerk to the Board

Calaveras County Water District
 Fiscal Year 2017-18
 Budget Adjustment - Number 18-02

From			To		
Department	Account	Amount	Department	Account	Amount
1 La Contenta Sewer Fund (Fund 564)	Reserves	(200,000)	La Contenta Sewer Fund (Fund 564)	Purchase of Properties Adjacent to the La Contenta Sewer Plant	200,000
2 Interest Reserve Fund (Fund 108)	Reserves	(440,000)	La Contenta Sewer Fund (Fund 564)	Purchase of Properties Adjacent to the La Contenta Sewer Plant	440,000
		(640,000)			640,000

Descriptions (for additional information please see staff report)

- 1 Increase appropriations by \$200,000 in the La Contenta Sewer Expansion Fund (Fund 564) to fund the purchase of properties adjacent to the La Contenta Wastewater Treatment Plant. The funding source is the La Contenta Sewer Expansion Fund Reserves (Fund 564).
- 2 Increase appropriations by \$440,000 in the Interest Reserve Fund (Fund 108) - Special Project Fund to loan funds to the La Contenta Sewer Expansion Fund (Fund 564) for the purchase of properties adjacent to the La Contenta Wastewater Treatment Plant. The funding source is the Interest Reserve Fund (Fund 108) - Special Projects Fund.

CALAVERAS COUNTY WATER DISTRICT
LA CONTENTA SEWER EXPANSION FUND LOAN AGREEMENT

THIS AGREEMENT is made and entered into this 13th day of December, 2017, by CALAVERAS COUNTY WATER DISTRICT (CCWD) for the purpose of loaning funds from the District's Interest Reserve Fund (Fund 108) to the La Contenta Sewer Expansion Fund (Fund 564) for the purchase of three (3) properties adjacent to the La Contenta Wastewater Treatment Plant that will improve wastewater service reliability and allow for expansion of services in the La Contenta service area.

The CCWD Board of Directors, by adoption of the Resolution 2017- ____, approved the purchase of APN's 046-019-051, 073-042-127, and 073-042-129 in Valley Springs, CA. The purchase price is \$635,000, plus closing costs. The La Contenta Sewer Expansion Fund (Fund 564) will contribute \$200,000 towards the purchase.

CCWD will loan an amount not to exceed \$440,000 from the Interest Reserve Fund (Fund 108) to the La Contenta Sewer Expansion Fund (Fund 564) to fund the balance of the purchase costs.

The loan repayment schedule will be for a term of not to exceed five (5) years at an interest rate of the greater of 2.5 percent (2.5%) or the weighted average of the District's current rate of return on investments. The applicable interest rate payable will be evaluated annually at the date of the annual loan payment. This loan will be subordinate to all other debt held by the District, either currently or in the future. Annual payments are estimated to be:

FY 2018-19	\$111,354
FY 2019-20	\$108,854
FY 2020-21	\$106,354
FY 2021-22	\$103,854
FY 2022-23	\$101,355

IN WITNESS WHEREOF, this agreement is hereby executed this day and year hereinabove written.

CALAVERAS COUNTY WATER DISTRICT

President
Board of Directors

ATTEST:

Mona Walker, Clerk to the Board

RESOLUTION NO. 2012 - 03

A RESOLUTION OF THE BOARD OF DIRECTORS
OF THE CALAVERAS COUNTY WATER DISTRICT

APPROVING INTERNAL LOAN AGREEMENT TO
FINANCE THE CCWD OPERATIONS HEADQUARTERS BUILDING
AT 267 GEORGE REED DRIVE
IN SAN ANDREAS, CA

WHEREAS, the Board of Directors of CALAVERAS COUNTY WATER DISTRICT has reviewed the INTERNAL LOAN AGREEMENT (attached hereto and made a part hereof) to finance the construction of the District's Operations Headquarters building located at 267 George Reed Drive, San Andreas, California; and

WHEREAS, the CALAVERAS COUNTY WATER DISTRICT has, as a result of the review, identified the District's Expansion Funds from which the loan will be made; and

WHEREAS, the CALAVERAS COUNTY WATER DISTRICT has stipulated that this loan not exceed an aggregate total of \$3,000,000 to be paid back in annual payments of principal and interest as outlined in the Agreement.

BE IT RESOLVED, by the Board of Directors of CALAVERAS COUNTY WATER DISTRICT that the INTERNAL LOAN AGREEMENT is hereby approved and adopted.

BE IT FURTHER RESOLVED, that the President is hereby authorized to execute said Agreement.

PASSED AND ADOPTED this 11th day of January, 2012, by the following vote:

AYES: Directors Davidson, Dean, Dooley and Stump
NOES: None
ABSTAIN: None
ABSENT: Director Ratterman

CALAVERAS COUNTY WATER DISTRICT

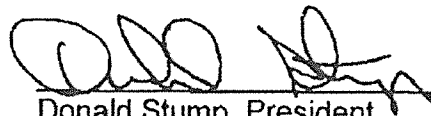
Donald Stump, President
Board of Directors

ATTEST:

Mona Walker, Clerk of the Board

CALAVERAS COUNTY WATER DISTRICT
INTERNAL LOAN AGREEMENT

TO FINANCE THE CCWD OPERATIONS HEADQUARTERS
BUILDING AT THE GEORGE REED DRIVE PROPERTY
IN SAN ANDREAS, CALIFORNIA

THIS AGREEMENT is made and entered into this 11th day of January, 2012, by CALAVERAS COUNTY WATER DISTRICT ("CCWD") for the purpose of loaning money from the District's expansion funds (as outlined below) to pay for the construction of an operations headquarters at the District's property at 267 George Reed Drive in San Andreas, California.

CCWD will loan an amount not to exceed \$3,000,000 from its "Expansion Funds" to the "Building Fund" as follows:

(304)	West Point Water	\$250,000
(524)	Forest Meadows Sewer	250,000
(534)	Vallecito Sewer	1,000,000
(544)	Arnold Sewer	500,000
(564)	La Contenta Sewer	500,000
(624)	West Point Sewer	500,000

The CCWD Board of Directors by minute entry on October 26, 2011, authorized internal funding of the operations headquarters as outlined, with a repayment schedule of ten years or less at an interest rate the greater of 2.5% or the weighted average of the District's current return on investments. The applicable interest rate payable will be reevaluated annually at the date determined for the annual loan payment

The Expansion Funds outlined above are not currently needed by the District in the short term as there is no projected growth in the areas covered by these Expansion Funds. Moreover, the one area that the Expansion Funds could have been used is the Vallecito area, but the District was able to secure a grant to perform the necessary improvements in the Vallecito area. Because the Expansion Funds are not currently being used and the investment income the District is receiving on those funds is minimal, the District has found it is the best interest of the District's rate payers to loan the funds as provided in this Agreement.

This internal loan will be repaid on an "interest only" basis for years one (1) through five (5). In years six (6) through ten (10), loan payments will consist of both interest and principal that will retire the loan in ten years. This loan will be subordinate to all other debt held by the District, either currently or in the future. Annual payments are estimated to be:

Years 1 through 5 (2013-2017)	\$75,000
Years 6 through 10 (2018-2022)	645,741

Initial and subsequent dates of annual repayment will be established at such time as the building has been completed and all accounting for borrowed funds has been verified and audited.

Principal and interest payments will be returned proportionately to the expansion funds where borrowed, resulting in an overall estimated earnings to those expansion funds of \$603,705.

IN WITNESS WHEREOF, this Agreement is hereby executed this day and year first hereinabove written.



Donald Stump, President
Board of Directors

ATTEST:



Mona Walker
Clerk of the Board

Agenda Item

DATE: December 13, 2017

TO: David Eggerton, General Manager 

FROM: Teresa Tanaka, Operations Director
Charles Palmer, District Engineer

RE: Discussion of, and Possible Action on Division 5 / Jenny Lind / Rancho Calaveras, Award of Contract for Installation/Construction of Water Pressure Regulating Station Improvements, CCWD CIP #11097

RECOMMENDED ACTION:

Motion: _____ / _____ adopting Resolution No. 2017- ____ accepting the bid by DRM Construction of Copperopolis, CA as the lowest responsive and responsible bid and authorizing the General Manager to execute a Construction Agreement with DRM Construction in the amount of \$158,000.00 for the Jenny Lind/Rancho Calaveras Water Pressure Regulating Station Improvements, CIP #11097.

SUMMARY:

In response to community concerns and to mitigate high pressure issues within certain areas of the Jenny Lind/Rancho Calaveras water system, the District wishes to expedite construction and installation of new pressure regulating stations at three different locations: 1) intersection of Goggin St. and McAtee St., 2) intersection of Goggin St. and Redman Rd., and 3) intersection of O'Reilly St. and McAtee St.. The District invited proposals from local contractors, conducted a pre-bid job walk and at a public bid opening on November 30, 2017, and received four (4) bids as tabulated below:

BIDDER	AMOUNT
K.W. Emerson, San Andreas	\$342,177.00
Ford Construction, Lodi	\$285,100.00
Cole Tiscornia Construction (CTC), Angels Camp	\$203,811.00
Devin McGee / DRM Construction, Copperopolis	\$158,000.00

Staff recommends accepting the bid submitted by DRM Construction as the lowest responsive and responsible bid and awarding/entering into a Construction Contract with DRM Construction for the subject project. The District plans to begin construction before January and to substantially complete the work by February 28, 2017 with the exception that additional time would be allowed for delays because of significant rain and severe weather conditions.

FINANCIAL CONSIDERATIONS:

A budget of \$190,000 is estimated for completing the construction contract and for engineering, construction management, and inspection. Also, the District has retained Condor Earth Technologies to perform soil density/compaction tests to comply with requirements of the road encroachment permit. The project is proposed to be funded by the water capital renovation and replacement fund, which will require a corresponding budget adjustment.

ITEM	BUDGET
Construction Contract	\$158,000.00
Engineering, Construction Management, Inspection, Compaction Tests, Etc.	\$ 32,000.00
TOTAL	\$190,000.00

- Attachments:* A) *Copy of Bid Submitted by DRM Construction*
 B) *Resolution Accepting Bids and Awarding Construction Contract*

**SECTION 00410
BID FORM**

Jenny Lind Water System
Pressure Regulating Station Improvements
(Goggin St., McAtee St., O'Reilly St. and Redman Rd.)
CIP #11097

TABLE OF ARTICLES

- Article 1 – Bid Recipient
- Article 2 – Bidder's Acknowledgments
- Article 3 – Bidder's Representations
- Article 4 – Bidder's Certification
- Article 5 – Basis of Bid
- Article 6 – Time of Completion
- Article 7 – Attachments to Bid
- Article 8 – Defined Terms
- Article 9 – Bid Submittal

ARTICLE 1- BID RECIPIENT

1.01 This Bid is submitted to: Calaveras County Water District at the main office at 120 Toma Court, San Andreas, CA 95249, no later than 3:00 PM local time on Thursday, November 30, 2017.

1.02 The undersigned Bidder proposes and agrees, if this Bid is accepted, to enter into an Agreement with Owner in the form included in the Bidding Documents to perform all Work as specified or indicated in the Bidding Documents for prices and within times indicated in this Bid and according to all terms and conditions of the Bidding Documents.

ARTICLE 2- BIDDER'S ACKNOWLEDGEMENTS

2.01 Bidder accepts all of the terms and conditions of the Instructions to Bidders, including without limitation those dealing with the disposition of Bid security. This Bid will remain subject to acceptance for 60 days after the Bid opening, or for such longer period of time that Bidder may agree to in writing upon request of Owner.

ARTICLE 3- BIDDER'S REPRESENTATIONS

In submitting this Bid, Bidder represents that:

A. Bidder has examined and carefully studied the Bidding Documents, the other related data identified in the Bidding Documents, and the following Addenda, receipt of which is hereby acknowledged.

Addendum No.	Addendum Date
<u> #1 </u>	<u> 11-15-17 </u>
_____	_____
_____	_____
_____	_____

B. Bidder has visited the Site and become familiar with and is satisfied as to the general, local and Site conditions that may affect cost, progress, and performance of the Work.

C. Bidder is familiar with and is satisfied as to all Federal, State and local Laws and Regulations that may affect cost, progress and performance of the Work.

D. Bidder has carefully studied all: (1) reports of explorations and tests of subsurface conditions at or contiguous to the Site and all drawings of physical conditions in or relating to existing surface or subsurface structures at or contiguous to the Site.

E. Bidder has considered the information known to Bidder; information commonly known to contractors doing business in the locality of the Site; information and observations obtained from visits to the Site; the Bidding Documents; and the Site-related reports and drawings identified in the Bidding Documents, with respect to the effect of such information, observations, and documents on (1) the cost, progress, and performance of the Work; (2) the means, methods, techniques, sequences, and procedures of construction to be employed by Bidder, including applying the specific means, methods, techniques, sequences, and procedures of construction expressly required by the Bidding Documents; and (3) Bidder's safety precautions and programs.

F. Based on the information and observations referred to in Paragraph 3.01.E above, Bidder does not consider that any further examinations, explorations, tests, studies, or data are necessary for the determination of this Bid for performance of the Work at the price(s) bid and within the times and in accordance with the other terms and conditions of the Bidding Documents.

G. Bidder is aware of the general nature of the Work to be performed by Owner and others at the Site that relates to the Work as indicated in the Bidding Documents.

H. Bidder has given Engineer written notice of all conflicts, errors, ambiguities, or discrepancies that Bidder has discovered in the Bidding Documents, and the written resolution thereof by Engineer is acceptable to Bidder.

I. The Bidding Documents are generally sufficient to indicate and convey understanding of all terms and conditions for the performance of the Work for which this Bid is submitted.

J. Bidder will submit written evidence of its authority to do business in the State or other jurisdiction where the Project is located not later than the date of its execution of the Agreement.

ARTICLE 4- BIDDER'S CERTIFICATION

4.01 Bidder further represents that:

A. This Bid is genuine and not made in the interest of or on behalf of any undisclosed individual or entity and is not submitted in conformity with any agreement or rules of any group, association, organization or corporation;

B. Bidder has not directly or indirectly induced or solicited any other Bidder to submit a false or sham Bid;

C. Bidder has not solicited or induced any individual or entity to refrain from bidding; and

D. Bidder has not engaged in corrupt, fraudulent, collusive, or coercive practices in competing for the Contract. For the purposes of this Paragraph 4.01.D:

1. "corrupt practice" means the offering, giving, receiving, or soliciting of anything of value likely to influence the action of a public official in the bidding process.

2. "fraudulent practice" means an intentional misrepresentation of facts made to (a) to influence the bidding process to the detriment of Owner, (b) to establish bid prices at artificial non-competitive levels, or (c) to deprive Owner of the benefits of free and open competition;

3. "collusive practice" means a scheme or arrangement between two or more Bidders, with or without the knowledge of Owner, a purpose of which is to establish bid prices at artificial, non-competitive levels; and

4. "coercive practice" means harming or threatening to harm, directly or indirectly, persons or their property to influence their participation in the bidding process or affect the execution of the Contract.

ARTICLE 5- BASIS OF BID

- 5.01 Bidder will complete the Work in accordance with the Contract Documents for the price(s) provided in the attached bid schedule (at the end of this section).
- 5.02 Unit Prices have been computed in accordance with Paragraph 11.04.B of the General Conditions
- 5.03 Bidder acknowledges that estimated quantities are not guaranteed, and are solely for the purpose of comparison of Bids, and final payment for all Unit Price Bid items will be based on actual quantities, determined as provided in the Contract Documents.
- 5.04 Bid Prices are for work that has been furnished and installed by the Contractor and is fully completed. The bid items as described and provided are for bidding and payment purposes and do not in any way limit the Contractor's responsibility to perform all work that may be reasonably inferred from the plans, specifications and other bid documents to produce the intended result.
- 5.05 All specified cash allowances are included in the price(s) set forth above and have been computed in accordance with Paragraph 13.02 of the General Conditions.
- 5.06 If "additive" or "deductive" Bid Items are included in the Bid- clearly identify the method for applying the alternates and the basis for award of the contract.

ARTICLE 6- TIME OF COMPLETION

- 6.01 Bidder agrees that the Work will be substantially complete and will be completed and ready for final payment in accordance with Paragraph 15.06 of the General Conditions on or before the dates or within the number of calendar days indicated in the Agreement.
- 6.02 Bidder accepts the provisions of the Agreement as to liquidated damages.

ARTICLE 7- ATTACHMENTS TO THIS BID

- 7.01 The following documents are attached to and made a condition of this Bid (Section 00410):

(ATTACH EACH DOCUMENT BELOW TO THE BID)

- A. Non-Collusion Affidavit (Section 00420);
- B. Required Bid security in the form of a Bid Bond or Certified Check (Section 00430);
- D. List of Subcontractors (Section 00470); and

ARTICLE 8- DEFINED TERMS

- 8.01 The terms used in this Bid with initial capital letters have the meanings stated in the Instructions to Bidders (Section 00200), General Conditions (Section 00700), Supplementary Conditions (Section 00800), and Special Conditions (00900).

ARTICLE 9- BID SUBMITTAL

9.01 This Bid is submitted by: DRM Construction

Bidder's Business address: P.O. Box 57
Copperopolis, CA 95228

Phone: 209-324-0272 Facsimile: 209-785-6474

Submitted on 11 | 30 |, 2017.

State Contractor License No. 830996

Employer's Tax ID No. 33-0393282

DIR Registration No. 1000051792

If Bidder is:

An Individual

Name (typed or printed): Devin Mcbee

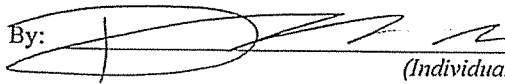
By:  _____
(Individual's signature)

Doing business as: DRM Construction

A Partnership

Partnership _____ Name: _____

(SEAL) _____

By: _____
(Signature of general partner - attach evidence of authority to sign)

Name (typed or printed): _____

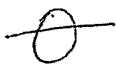

A Corporation

Corporation Name: _____

(SEAL) _____

State of Incorporation: _____

Type (General Business, Professional, Service, Limited Liability): _____

By: _____
(Signature – attach evidence of authority to sign)

Name (typed or printed): _____

Title: _____

Attest: _____
(Signature of Corporate Secretary)

Date of Qualification to do business is ____ \ ____ \ ____.

A Joint Venture

Name of Joint Venture: _____

First Joint Venture Partner Name: _____

(SEAL) _____

By: _____
(Signature of first joint venture partner – attach evidence of authority to sign)

Name (typed or printed): _____

Title: _____

Second Joint Venture Partner Name: _____

(SEAL) _____

By: _____
(Signature of second joint venture partner – attach evidence of authority to sign)

Name (typed or printed): _____

Title: _____

(Each joint venture partner must sign. The manner of signing for each individual, partnership, and corporation that is a party to the joint venture should be in the manner indicated above.)

(This page intentionally left blank)

BID SCHEDULE
Jenny Lind Water System
Pressure Regulating Station Improvements
CIP #11097

<u>ITEM</u>	<u>DESCRIPTION</u>	<u>UNIT</u>	<u>QTY</u>	<u>UNIT PRICE</u>	<u>BID AMOUNT</u>
1	<u>MOBILIZATION/DEMOBILIZATION</u> : This item includes bonds, insurance, meetings, submittals, scheduling, staging, equipment mobilization and demobilization, temporary facilities, erosion controls, final clean-up and other general provisions and requirements (<i>one-time payment not exceeding 10% of the total contract amount</i>).	Lump Sum	1	-	\$ <u>8,000 -</u>
2	<u>SHEETING, SHORING & BRACING</u> : For workers entering any excavation 5-ft in depth or greater, provide sheeting, shoring and bracing complying with California Labor Code, Department of Industrial Relations Construction Safety Orders Sections 1539 to 1543.	Lump Sum	1	-	\$ <u>8,000 -</u>
3	<u>ENCROACHMENT/TRAFFIC CONTROLS</u> : According to California Manual on Uniform Traffic Control Devices (MUTCD) 2014 edition, provide temporary traffic controls including all necessary signage, flaggers, barricades, k-rails, safety devices, etc. Schedule/notify County of all road lane closures, and satisfy encroachment permit requirements.	Lump Sum	1	-	\$ <u>20,000 -</u>
4	<u>STORMWATER BMP's BEST MANAGEMENT PRACTICES (BMPs)</u> : Provide erosion and sediment controls and other construction BMPs according to California Stormwater Quality Association (CASQA) Handbook, e.g. straw mulch, silt fence, fiber rolls, street sweeping and vacuuming, sandbag barriers, storm drain inlet protection, etc. Also, provide advised BMPs for dewatering, paving and grinding operations, stockpile management, and concrete waste management.	Lump Sum	1	-	\$ <u>10,000 -</u>
5	<u>PRESSURE REGULATING STATIONS</u> : The pressure regulating stations (precast vaults and cover slabs) currently located at District's warehouse at Campbell Ct. off Hogan Dam Rd. are to be loaded, moved, then unloaded and set at each of the three sites. Steps include excavating/setting precast vaults, forming and casting-in-place reinforced concrete risers (between vaults and cover slabs) and setting precast cover slabs to surface grade/elevation. Provide Class 2 A.B. leveling courses and backfill. To avoid damaging air valves removed, then reinstall after setting cover slabs. Also, recess/fit surge valves inside each vault by rotating 90-degrees and re-plumbing stainless steel piping to valve inlet. Furnish/install surge boxes per CCWD Detail W14 and extend stainless steel piping from surge valves to boxes. Pressure test, disinfect, flush and pass bacteriological tests before connecting to existing system.	Each	3	\$ <u>10,000 -</u>	\$ <u>30,000 -</u>

BID SCHEDULE
Jenny Lind Water System
Pressure Regulating Station Improvements
CIP #11097

<u>ITEM</u>	<u>DESCRIPTION</u>	<u>UNIT</u>	<u>QTY</u>	<u>UNIT PRICE</u>	<u>BID AMOUNT</u>
6	<u>INLET & OUTLET PIPING:</u> As shown on the project Drawings, furnish/install 6" inlet and outlet piping from each new pressure regulating station to existing water mains by open-cut trench per CCWD Details G05 and backfilled with Class 2 A.B. Provide ductile iron pipe, fittings and gate valves complying with AWWA C151, C153, and C515, respectively. For all fittings, provide mechanical thrust restraints with redundant thrust blocking per CCWD Detail W01. Make tie-in connections during scheduled shutdowns (max. 4-hrs) and pre-assemble pipe, fittings, and valves and swab with chlorine. All other piping to be pressure tested, disinfected, flushed and pass bacteriological tests before being connecting to existing water system.	Each	3	\$ 17,000	\$ 51,000-
7	<u>DEMOLISH EXISTING PRESSURE REGULATING VALVES:</u> At O'Reilly St. & McAtee St. and O'Reilly St. & Redman Rd., demolish/remove and dispose of two (2) existing pressure regulating valves and corresponding vaults. Remove existing valve bodies and existing flanged end hubs and replace with ductile iron spools with transition couplings EBA-2100 Mega-Flanges. Gauge all pipe field cut ends for roundness and slightly beveled/filed (1/8" @ 45°) to remove outward sharp edges. Wrap/secure in polyethylene encasement, backfill with Class 2 A.B. and compact to 95% relative density.	Each	2	\$ 5,000-	\$ 10,000-
8	<u>HOT MIX A.C. PAVING:</u> At Goggin & Redman, Goggin & McAtee, and O'Rielly & Redman, furnish/install new min. 2.5" thick Type B hot mix asphaltic paving per Section 39 of State Standards; saw-cut, remove and dispose of existing pavement; grind transitions and overlay areas, pre-treat joints/edges and overlay areas with emulsion; evenly place, roll and fully compact hot mix asphalt; repaint markings and lines. Extents of new paving to be determined in field and/or as directed by County Public Works. Provide temporary cold patch.	Square Feet	600 800	\$ 20-	\$ 12,000-
9	<u>GRAVITY BLOCK WALL (OPTIONAL ITEM):</u> For station at O'Reilly St. and McAtee St., provide gravity block retaining wall of approximately 3' tall x 20' long consisting of Basalite Geowall Pro, Estate or equal and construct according to manufacturer's instructions. Provide free draining, large gravel drain wrapped in filter fabric and backfill behind wall.	Square Feet	60	\$ 150	\$ 9,000-
TOTAL BID AMOUNT ALL ITEMS (NUMERICAL)				\$	158,000-

TOTAL BID AMOUNT (WRITTEN):

One hundred Fifty-eight thousand & 00/100 DOLLARS

RESOLUTION NO. 2017 -

A RESOLUTION OF THE BOARD OF DIRECTORS OF THE
CALAVERAS COUNTY WATER DISTRICT

ACCEPTING BIDS AND AWARD OF CONSTRUCTION CONTRACT FOR
JENNY LIND / RANCHO CALAVERAS INSTALLATION OF
WATER PRESSURE REGULATING STATION IMPROVEMENTS
CCWD CIP #11097

WHEREAS, in response to community concerns and to mitigate high pressures in certain areas of the Jenny Lind and Rancho Calaveras water system, the District wished to expedite construction of new pressure regulating stations at three locations including: 1) intersection of Goggin Street and McAtee Street, 2) intersection of Goggin Street and Redman Road, and 3) intersection of O'Reilly Street and McAtee Street; and

WHEREAS, for said project, the District prepared plans and specifications, invited proposals from local contractors, conducted a pre-bid job walk and held a public bid opening on November 30, 2017 at which four (4) bids were received with DRM Construction being the lowest responsive and responsible bid in the amount of \$158,000.00.

NOW, THEREFORE, BE IT RESOLVED that the Board of Directors of the Calaveras County Water District hereby awards a contract to DRM Construction as the lowest responsive and responsible bidder and authorizes the General Manager to execute said contract with DRM Construction in an amount of \$158,000.00 for the Jenny Lind, Rancho Calaveras Water Pressure Regulating Station Improvements, CIP #11097.

BE IT FURTHER RESOLVED that the Board of Directors hereby authorizes funding of said contract and other related project costs totaling \$190,000 to be secured by the Water Capital Renovation and Replacement Fund (Fund #125).

PASSED AND ADOPTED this 13th day of December, 2017 by the following vote:

AYES:

NOES:

ABSTAIN:

ABSENT:

CALAVERAS COUNTY WATER DISTRICT

President
Board of Directors

ATTEST:

Mona Walker, Clerk to the Board

Agenda Item

DATE: December 13, 2017

TO: Dave Eggerton, General Manager 

FROM: Jeffrey Meyer, Director of Administrative Services

RE: Discussion / Action Regarding Amending the FY 2017-18 CIP Budget for the Jenny Lind/Rancho Calaveras Pressure Regulating Station Improvements Project, CCWD CIP #11097

RECOMMENDED ACTION:

Motion: _____ / _____ approving Resolution No. 2017- _____ Amending the FY 2017-18 CIP Budget for the Jenny Lind/Rancho Calaveras Pressure Regulating Station Improvements Project, CCWD CIP #11097.

SUMMARY:

District staff has determined that the Jenny Lind/Rancho Calaveras Pressure Regulating Station Improvements Project, CCWD CIP #11097, which will improve water pressure and water reliability in the Rancho Calaveras service area, needs to be added to the FY 2017-18 Capital Improvement Program (CIP). The project will include the modification and installation of three (3) pressure regulating valves. District staff designed the project and solicited bids from four local contractors.

The bids were received and opened on November 30, 2017. The lowest responsive bid of \$158,000 was submitted by DRM Construction. In addition to the DRM Construction costs, staff time for engineering, construction management and inspection, and other project costs will bring the total project cost to \$190,000. It is anticipated that the project will be substantially completed by February 28, 2018.

FINANCIAL CONSIDERATIONS:

Total expenditures for the Jenny Lind/Rancho Calaveras Pressure Regulating Station Improvements Project (CCWD CIP #11097) are estimated to be \$190,000. Funding will be provided by the Water Capital Renovation and Replacement Fund (Fund 125). The adopted FY 2017-18 CIP Budget of \$10,767,000 will be increased by \$190,000.

Attachment: Resolution 2017 - _____ Amending the FY 2017-18 CIP Budget for the Jenny Lind/Rancho Calaveras Pressure Regulating Station Improvements Project, CCWD CIP #11097

RESOLUTION NO. 2017-

**A RESOLUTION OF THE BOARD OF DIRECTORS OF THE
CALAVERAS COUNTY WATER DISTRICT**

**AMENDING THE FY 2017-18 CIP BUDGET FOR THE
JENNY LIND/RANCHO CALAVERAS PRESSURE REGULATING STATION
IMPROVEMENT PROJECT (CCWD CIP #11097)**

WHEREAS, the Board of Directors of the CALAVERAS COUNTY WATER DISTRICT adopted Resolution 2017-29 on June 28, 2017 approving the Fiscal Year 2017-18 Capital Improvement Program Budget (CIP) in the amount of \$10,767,000; and

WHEREAS, the District has determined that the Jenny Lind/Rancho Calaveras Pressure Regulating Station Improvements Project (CCWD CIP #11097) will improve water pressure and water reliability in Rancho Calaveras and needs to be added to the FY 2017-18 CIP budget; and

WHEREAS, the Jenny Lind/Rancho Calaveras Pressure Regulating Station Improvements Project, including design, construction, and construction related expenses, is estimated at \$190,000; and

WHEREAS, funding is available in the Water Capital Renovation and Replacement Fund (Fund 125) to fund the project; and

WHEREAS, the Board of Directors of the CALAVERAS COUNTY WATER DISTRICT does hereby find that it is in the best interest of the Calaveras County Water District to amend the adopted FY 2017-18 CIP Budget accordingly.

NOW, THEREFORE BE IT RESOLVED the Board of Directors of the CALAVERAS COUNTY WATER DISTRICT adopts an amendment to the Fiscal Year 2017-18 Capital Improvement Program (CIP) Budget as set forth in Budget Adjustment 18-03, attached hereto and made a part hereof, and authorizes the Director of Administrative Services to record the appropriate accounting entries.

/

/

/

PASSED AND ADOPTED this 13th day of December, 2017 by the following vote:

AYES:

NOES:

ABSTAIN:

ABSENT:

CALAVERAS COUNTY WATER DISTRICT

President
Board of Directors

ATTEST:

Mona Walker, Clerk to the Board



Calaveras County Water District
 Fiscal Year 2017-18
 Budget Adjustment - Number 18-03

From			To		
Department	Account	Amount	Department	Account	Amount
1 Water Capital R&R Fund (Fund 125)	Reserves	(190,000)	Water Capital R&R Fund (Fund 125)	Jenny Lind/Rancho Calaveras Pressure Regulating Station Project	190,000
		(190,000)			190,000

Descriptions (for additional information please see staff report)

- 1 Increase appropriations by \$190,000 in the Water Capital Renovation and Replacement (Capital R&R) Fund (Fund 125) to fund the Jenny Lind/Rancho Calaveras Pressure Regulating Station Improvements Project (CCWD CIP #11097). The funding source is the Water Capital R&R Fund Reserves (Fund 125).

Agenda Item

DATE: December 13, 2017
TO: Dave Eggerton, General Manager 
FROM: Jeffrey Meyer, Director of Administrative Services 
SUBJECT: Discussion/Direction Regarding Cost of Service and Rate Design Analysis

RECOMMENDED ACTION:

Discussion/direction regarding Cost of Service and Rate Design Analysis.

SUMMARY:

At the November 21, 2017 Finance Committee meeting, Tom Gould of HDR Engineering, Inc. presented an overview of the Cost of Service and Rate Design Analysis for the water and sewer utilities. The presentation reviewed the objectives of a cost of service study, the separation of costs into customer classes, and the impact recent court cases have had on rate designs for tiered water rates.

Shawn Koorn of HDR Engineering, Inc. HDR will review the November 21st presentation with the Board and will present preliminary cost of service results. Additionally, Mr. Koorn will discuss water and sewer rate structure options and request direction from the Board on finalizing the Cost of Service Study and the rate design alternatives.

FINANCIAL CONSIDERATIONS:

None at this time.